

FOXX

EQUIPMENT COMPANY

DEDICATED TO THE MANUFACTURE AND DISTRIBUTION OF
BEVERAGE DISPENSING EQUIPMENT SINCE 1956

2019

WWW.FOXXEQUIPMENT.COM



the Joy of Dispensing

WHOLESALE ONLY



Dear Foxx Customer,

This is our 64th year of participating in the success of YOU, our beverage dispensing equipment customers! We have always tried to listen to your special requirements for parts and services. This year we have again added several new items and worked diligently to keep our costs down and pass the savings along to you.

We are pleased to once again present our catalog in full color. We have added several new pages packed with new items. We also continue to improve the overall flow of the catalog in an ongoing effort to aid our customers in easily finding the products they are looking for.

Our website is up-to-date and includes a fully functional shopping cart feature. Please be patient with our site, as we continue to make improvements and fix minor issues. We will continue to work on the site as we have the catalog, to make it as user friendly as we possibly can. We hope these changes benefit you, our valued customer.

Ford Maurer, President

NEW

TRI-CLOVER COMPATIBLE FITTINGS & VALVES (pg. 236-246)

FOR 2019 WE HAVE ADDED OVER 80 NEW TRI-CLOVER COMPATIBLE PRODUCTS
IN ADDITION TO OUR EXTENSIVE INVENTORY.

- 304/304L STAINLESS STEEL COMPONENTS
- EASY TO CLEAN IN PLACE OR DISMANTLED
- SMOOTH INTERNAL DIAMETER
- NO EXPOSED THREADED CONNECTIONS



CO₂ Cylinders and Accessories			2-10
Changeovers (automatic & manual)	Cylinder Carry Handles	Cylinder Labeling	
CO ₂ Alarms	Cylinder Storage / Transport Racks	Cylinder Thread Protection	
Cylinders (CO ₂ and N ₂)	Cylinder Mounting Brackets	Cylinder Valves (CO ₂ and N ₂)	
Soda Related Products			11-67
Bag N' Box Products	Ice Chests	Soda / Water Fountain	
Carbonation Testers	Pre-Mix Dispensers	Soda Valves	
Carbonator Motors	Procon Rotary Vane Pumps	Syrup Pumps	
Carbonators & Accessories	Product Tanks, Parts & Accessories	Syrup Separators	
Disconnects (plastic & stainless steel)	Refractometers	Thermometers	
Dispensers (soda / ice drink)	Regulators / Air Distributors	Wunder-Bar Bar Guns	
Water Related Products			68-75
Bottled Water Pump	Faucets	Water Boosters Systems I Pumps	
Copper Tubing	Filtration Systems & Cartridges	Water Pressure Regulators	
Dispensers & Glass Fillers	Saddle Valves		
Tubing and Clamps			76-84
Clamps (All types)	Tapes (duct, foil, marking & vinyl)	Tubings (all types & brands)	
Foam Tube Insulation	Tools (hose cutters & clamp pincers)	Tubing (beverage bundles)	
Fittings and Ball Valves			85-103
Brass Fittings	Push-In Tube Fittings	Stainless Steel Fittings	
Plastic Fittings	Quick Disconnects (Colder Products)	Valves (ball & needle)	
Refrigeration Related Products			104-108
Access Valves, Driers & Copper Tubing	Compressors (universal)	Refrigeration Service Equipment	
Agitator Motors & Blades	Condensation Removal Equipment	Submersible Agitator Pumps	
Cold Controls (replacement & portable)	Condenser Fan Motors	Thermometers	
Vending and Security Products			109
Cleaning Cards (bill / credit card readers)	Pocket Multi-Tester (volts, amps, ohms)	Vending Machine Locks (fits T-handles)	
Heat Gun (professional)	Padlocks (keyed alike for security control)		
Material Handling and Tools			110-118
Hand Trucks (for cylinders)	Hand Trucks (for vending equipment)	Tools (hand tools for general use)	
Hand Trucks (for general use)	Storage Satchels & Organizers	Tools (Leatherman multi-tools)	
Chemicals and Cleaning Products			119-130
Brushes (faucet & direct draw cleaning)	Glass Washing Equipment	Line Cleaning Equipment	
Chemicals (line cleaning, sanitizers, & more)	Gloves (Nitrile)	Lubricants (grease tubes & sprays)	
Degreasers	Insecticide Spray	Polisher & Cleaner	
Wine and Coffee Related Products			131-135
Faucets	Keg Couplers	Shanks	
Fittings & Connections	Regulators (N ₂)	Towers & Columns	
Perlick Quick Chill Products			136-146
Drains	Power Paks (Glycol Chillers)	Towers & Columns	
Beer Related Products			147-235
Air Compressors	Cold Plates & Stainless Steel Coils	Insect Control Products	
Air Distributors	Columns & Towers	Keg Couplers	
Beer Engines	Dispensers (portable & countertop)	Kege Management	
Beer Pumps & Accessories	Drains & Rinsers	Motors	
Beverage-Air Equipment	Faucets, Handles & Accessories	Picnic Pumps & Special Event	
Blenders (for gases)	Fittings & Connections	Refractometers	
Blowers, Brackets & Accessories	Flash Chillers & Chill Plates	Regulators, Panels	
Cask Conditioned Beer Equipment	Foam Preventers	Shanks	
Changeovers for CO ₂ Tanks	Glycol Chillers, Trunklines & Glycol	Tubings, Clamps & Accessories	
Brewery Related Products			236-247
Brushes (cleaning)	Silicone Tubings (high temperature)	Tri-Clover Compatible Fittings & Valves	
Gloves (Brewers & Nitrile)	Sample Valves & Proofing Coil	Tri-Clover Compatible Gaskets	
Home Brew Related Products			248-253
Bottle Fillers	Erlenmeyer Flasks	Hydrometers	
Chemicals	Filtration Products	Product Tanks & Insulation Jackets	
Disconnects	Home Brew Kegging Kits	Refrigerator Conversion Kits	



CO₂ Cylinders



Produced from high strength aluminum alloy 6061-T6. Includes a Sherwood brand GV series valve.

REGULATION AND INSPECTION: All seamless aluminum alloy compressed gas cylinders are manufactured in accordance with U.S. DOT 3AL and TC 3ALM requirements. Every cylinder is inspected and tested by a DOT and TC authorized independent inspection agency.

NOTE: Cylinders have D.O.T. approval to be filled with several gases including NITROGEN, BLENDED GAS, etc. Check with your local filler or welding supply. Fillable up to 1800 PSI



Sherwood



CO₂ Cylinders – Aluminum 1800 PSI working pressure

NOTE: Filled cylinders require a HAZARDOUS MATERIALS fee by UPS

Catalog No	Cylinder Size	Max Fill	Carry Handle	Empty or Filled	Diameter	Overall Height	Overall Weight	100+	50+	25+	10+	Each
01F05-101	2-1/2 lb.	2-1/2 lb.	No	Empty	4-1/4"	13-1/2"	4.3 lbs	48.95	49.95	50.95	51.95	53.95
01F05-102	2-1/2 lb.	2-1/2 lb.	No	Filled	4-1/4"	13-1/2"	6.8 lbs	53.95	54.95	55.95	57.95	59.95
01F05-103	5 lb.	5 lb.	No	Empty	5-1/4"	17-3/8"	7.5 lbs	50.95	52.95	53.95	54.95	56.95
01F05-104	5 lb.	5 lb.	No	Filled	5-1/4"	17-3/8"	12.5 lbs	56.95	57.95	58.95	60.95	62.95
01F05-105	10 lb.	10 lb.	No	Empty	6-3/4"	19-3/4"	13.7 lbs	71.95	73.95	75.95	77.95	80.95
01F05-110	10 lb.	10 lb.	Yes	Empty	6-3/4"	19-3/4"	14.2 lbs	74.95	76.95	78.95	81.95	83.95
01F05-113	20 lb.	20 lb.	No	Empty	8"	26-1/4"	25 lbs	97.95	100.95	102.95	104.95	108.95
01F05-106	20 lb.	20 lb.	Yes	Empty	8"	26-1/4"	25.5 lbs	102.95	104.95	107.95	110.95	113.95
01F05-108	50 lb.	50 lb.	Yes	Empty	8-5/8"	50-1/2"	50.5 lbs	236.95	242.95	248.95	255.95	262.95

Nitrogen Cylinders – Aluminum 1800 PSI working pressure

01F05-114	2-1/2 lb.	7.2 cu.ft.	No	Empty	4-1/4"	13-1/2"	4.3 lbs	55.95	57.95	58.95	60.95	61.95
01F05-115	5 lb.	14.5 cu.ft.	No	Empty	5-1/4"	17-3/8"	7.5 lbs	65.95	67.95	69.95	71.95	73.95
01F05-119	10 lb.	29 cu.ft.	No	Empty	6-3/4"	19-3/4"	13.7 lbs	78.95	80.95	82.95	85.95	87.95
01F05-118	10 lb.	29 cu.ft.	Yes	Empty	6-3/4"	19-3/4"	14.2 lbs	84.95	86.95	88.95	91.95	93.95
01F05-117	20 lb.	57.6 cu.ft.	No	Empty	8"	26-1/4"	25 lbs	106.95	109.95	112.95	115.95	118.95
01F05-116	20 lb.	57.6 cu.ft.	Yes	Empty	8"	26-1/4"	25.5 lbs	110.95	113.95	116.95	119.95	122.95
01F05-122	50 lb.	144 cu.ft.	Yes	Empty	8-5/8"	50-1/2"	50.5 lbs	246.95	252.95	259.95	266.95	273.95

NOTE: Brand of cylinders stocked may vary depending upon cost and availability. Pallet pricing available on orders shipped direct from the manufacturer. Contact your representative for details.

Painting and Stamping

FOR EASY IDENTIFICATION

STAMPING



- DOME ONLY PAINT (specify color) \$5.00
- ENTIRE CYLINDER PAINT (specify color)
- 2.5 lb. & 5 lb. cylinders \$8.00
- 10 lb. & 20 lb. cylinders \$15.00
- 50 lb. cylinders \$20.00



USE ANY COMBINATION OF LETTERS AND NUMBERS

50¢ PER EACH

SAFETY COLORS: Yellow, blue, red, green, orange (other colors available upon request)



Denver 800-525-2484



WARNING
CANCER AND REPRODUCTIVE HARM.
WWW.P65WARNINGS.CA.GOV

Prices subject to change without notice

THE ELIMINATOR

AUTOMATIC CYLINDER CHANGEOVER VALVE – THE ONE THAT ACTUALLY WORKS AND WORKS AND...

COMPLETELY AUTOMATIC • NON-ELECTRIC • FOOLPROOF • EASY TO INSTALL

HOW THE ELIMINATOR WORKS!

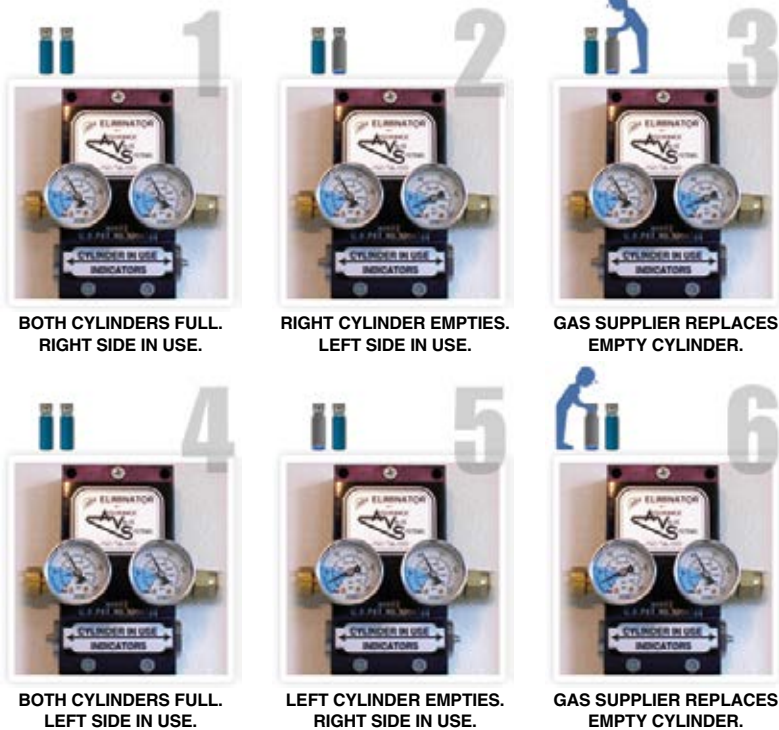

AVAILABLE CONNECTION MODELS

2 tank • 4 tank • 6 tank • 8 tank

20 YEAR MFG. WARRANTY

INCLUDES: Changeover valve, 4' high pressure hoses with tank connections

(Outgoing regulator sold separately)

FOR CO ₂ TANKS		
Catalog No.	Description	Each
02A03-112	2 Tank Changeover	479.00
02A03-114	4 Tank Changeover (pictured)	623.00
02A03-116	6 Tank Changeover	706.00
02A03-118	8 Tank Changeover	792.00

FOR NITROGEN TANKS		
Catalog No.	Description	Each
02A03-212	2 Tank Changeover	479.00
02A03-214	4 Tank Changeover (pictured)	623.00
02A03-216	6 Tank Changeover	706.00
02A03-218	8 Tank Changeover	792.00

20 lb. Cylinder Storage / Transportation Racks

- Meets the DOT Code of Federal Regulations for safe and efficient storage and transportation of compressed gases
- Rigid welded frames constructed of heavy gauge, zinc plated steel tubing
- Racks are forkliftable from front or side and are stackable
- Racks are shipped direct from the manufacturer only



16-Cylinder Stackable Model

Overall dimensions 36"D x 37"W x 36"H

Overall empty rack weight 152 lbs.

02C04-100

5+ \$600.00 3+ \$620.00 Ea. \$640.00

Manual CO₂ and N₂ Cylinder Changeovers

AN AFFORDABLE ALTERNATIVE TO AUTOMATIC CHANGEOVERS

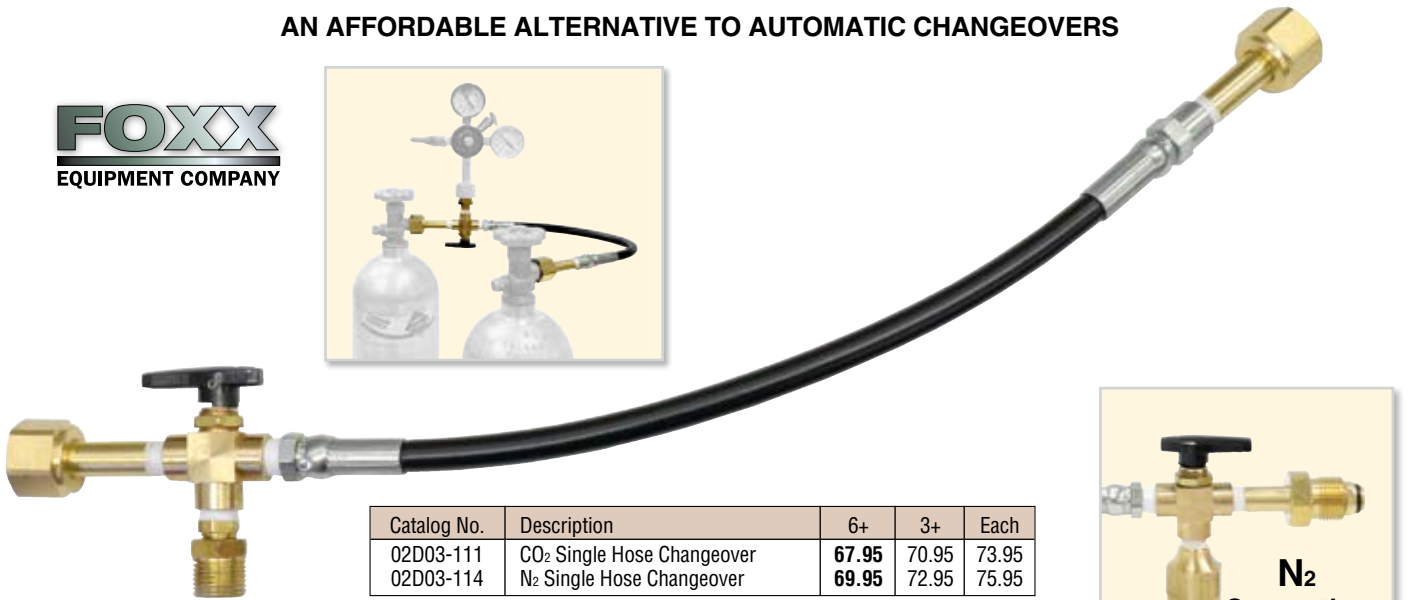

REGULATOR ATTACHES HERE

Catalog No.	Description	6+	3+	Each
02D03-111	CO ₂ Single Hose Changeover	67.95	70.95	73.95
02D03-114	N ₂ Single Hose Changeover	69.95	72.95	75.95

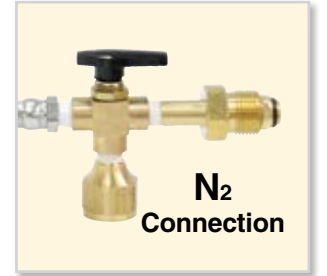

N₂ Connection

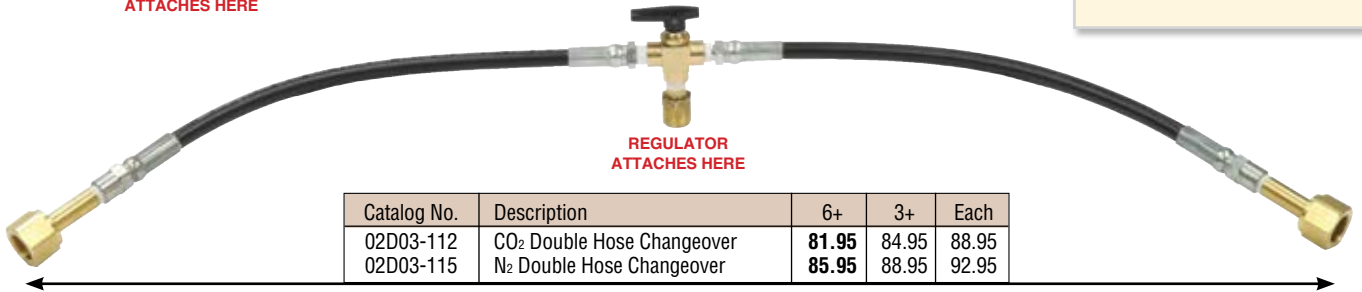

REGULATOR ATTACHES HERE

Catalog No.	Description	6+	3+	Each
02D03-112	CO ₂ Double Hose Changeover	81.95	84.95	88.95
02D03-115	N ₂ Double Hose Changeover	85.95	88.95	92.95

Additional price breaks available on most items. Login to your website account or contact your sales representative for pricing.

Low Pressure Changeover Valve

SWITCH CYLINDERS WITHOUT SERVICE INTERRUPTION

LOW COST ALTERNATIVE TO HIGH PRESSURE AND AUTO CHANGEOVERS

Connect valve to the low pressure outlets of two regulators via beverage tubing and 1/4" MFL fittings

02C03-289

50+ \$18.50

25+ \$18.95 10+ \$19.95

Ea. \$20.95

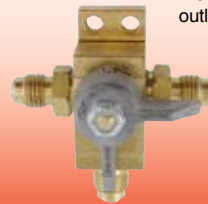
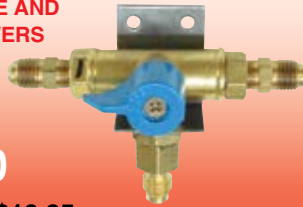

02S03-289

50+ \$18.50

25+ \$18.95 10+ \$19.95

Ea. \$20.95



6' High Pressure Regulator to Cylinder Hose

FOR WALL MOUNTING REGULATOR

One end connects directly to cylinder and the other end directly to 1/4" FPT inlet on regulator. Allows 6' for adjustable wall mounting.

Additional price breaks available

Catalog No.	Description	Each
03G07-311	Right Hand Thread	28.95
03D03-199	Left Hand Thread	31.95



RATED FOR 2,750 PSI

AVAILABLE IN RIGHT OR LEFT HAND THREAD CONNECTIONS

6' Blowout Cleaning Hose

Attaches directly to CO₂ cylinder. Blows dirt out of refrigeration condensers in seconds.

CAUTION: TURN ON CO₂ SLOWLY!

Catalog No.	Description	25+	10+	Each
02D03-141	Blowout Hose 6'	5.95	6.25	6.50
04E04-391	Fitting Only	3.75	-	3.95



Denver 800-525-2484



WARNING
CANCER AND REPRODUCTIVE HARM.
WWW.P65WARNINGS.CA.GOV

Prices subject to change without notice

CO₂ Cylinders and Accessories

Carbon Dioxide Gas Detector and Alarm System

CO₂ ALARMS HELP TO PREVENT ASPHYXIATION AND DEATH WHERE CO₂ IS USED OR STORED

CO₂ Hand Held Gas Detector

**FOR USE BY
SERVICE PERSONNEL
WHEN DEALING
WITH EQUIPMENT
USING CO₂ IN
CONFINED AREAS**



**MEETS
STATE & LOCAL
MUNICIPALITY
INSPECTION
CODES**

**CONNECT UP TO
3 REMOTE UNITS
FOR MULTIPLE
ENTRYWAYS**

**DESIGNED TO
SPOT CHECK CO₂ LEVELS**

- Measures CO₂ levels in PPM
- Measures temperature in F or C
- Easy calibration in fresh air
- Large easy-to-read LCD display
- Audible alarm

- CO₂ Accuracy: ± 50ppm, or 5% of reading (0~5,000 ppm)
- Includes: Lithium-ion batteries, SD card 16G for data logging, USB charger, manual

CO₂ Storage Safety 3 Alarm



**EASY
TO INSTALL**

- 3 alarm settings and relays to insure code compliance
- New, faster responding sensor uses latest NDIR technology
- Display indicates the current CO₂ level and temperature

- Meets OSHA, IFC and NFPA code requirements for CO₂ alarms in restaurants, bars, breweries, etc.
- Has both audible and visual alarms
- Can easily connect warning lights and battery backup (sold separately)

02C02-200 **\$299.00**

02C02-110 **\$595.00**

Carry Handles for Aluminum Cylinders

PROTECTS THE VALVE AND AIDS IN THE TRANSPORTATION OF THE CYLINDER



FITS: **Kidde**

FITS: **CATALINA CYLINDERS**

FITS: **Luxfer**

FITS: **Luxfer**

Ref.#	Catalog No.	Description	50+	25+	Each
1	02F05-101	Kidde Handle Premium (w/snap ring)	8.95	9.50	9.95
2	02F05-301	Kidde Handle Economy (no snap ring)	4.11	4.46	4.95
3	02F05-107	Catalina Handle Premium (w/snap ring)	5.95	6.50	6.95
3	02F05-120	Luxfer Handle Premium (Catalina style)	5.95	6.50	6.95
4	02F05-307	Catalina Handle Economy (no snap ring)	4.11	4.46	4.95
5	02F05-110	Luxfer Handle Premium (no snap ring)	5.95	6.50	6.95

Ref.#	Catalog No.	Description	50+	25+	Each
6	02F05-310	Luxfer Handle Economy (no snap ring)	4.11	4.46	4.95
7	02F05-115	Luxfer Cylinder Cap (threaded)	11.50	11.95	12.95
8	02F05-112	Luxfer Adapter Ring (threaded)	8.50	8.95	9.50
9	02F05-102	Kidde Snap Ring	1.07	1.10	1.16
10	02F05-108	Catalina Snap Ring	0.75	0.79	0.85
11	02F05-111	Luxfer Snap Ring	0.75	0.79	0.85

KIDDE NECK = 2-3/16" diameter • LUXFER NECK = 2-3/8" diameter • CATALINA NECK = 2-5/8" diameter

Steel Cylinder Accessories



Conversion Kit

Everything you need to adapt a carry handle to a steel cylinder.

02D03-108

100+ **\$13.95**

50+ \$14.95 25+ \$15.95
10+ \$16.95 Ea. \$17.95



Carry Handle Adapter Ring Only

Allows steel cylinders to accept a Luxfer carry handle

1-7/8" ID x 2-3/8" OD

02A01-102

100+ **\$9.95**

50+ \$10.50 25+ \$10.95
10+ \$11.50 Ea. \$11.95



Tank Boot

Fits 20 lb. round bottom steel cylinders that are 8" in diameter

02J05-150

100+ **\$12.95**

50+ \$13.95 25+ \$14.95
10+ \$15.95 Ea. \$16.95

CO₂ Wrenches and Snap Ring Pliers

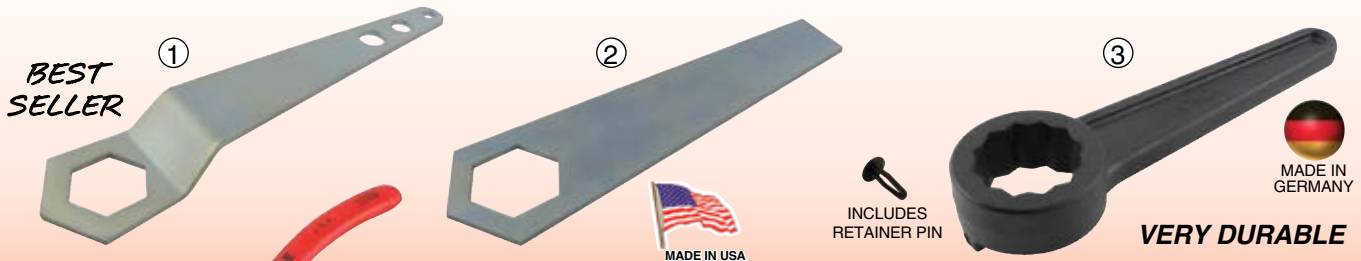

ADDITIONAL VOLUME PRICE BREAKS AVAILABLE

ACCESS YOUR WEBSITE ACCOUNT FOR CONTACT YOUR SALES REPRESENTATIVE FOR MORE INFORMATION

Ref.#	Catalog No.	Description	50+	25+	Each
1	20K08-104	Metal CO ₂ Wrench (Offset)	1.75	1.85	1.95
2	20K08-103	Metal CO ₂ Wrench (Flat)	1.84	1.95	2.05
3	20K08-105	Plastic CO ₂ Wrench with Pin	1.95	2.05	2.25
Ref.#	Catalog No.	Description	6+	3+	Each
4	20R09-170	Snap Ring Plier (90°.115 tips)	17.95	18.95	19.95

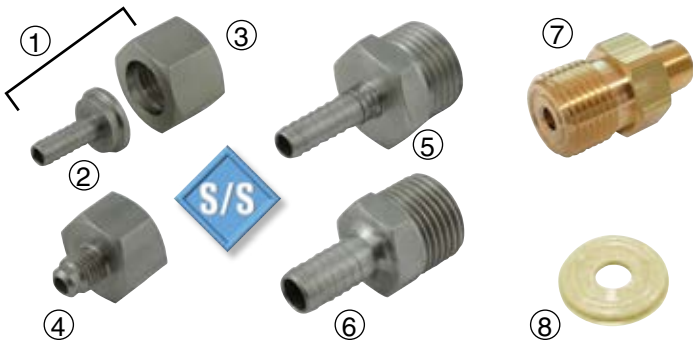

CO₂ Thread Compatible Fittings .825-14 NGO RH

Ref.#	Catalog No.	Description	100+	50+	25+	Each
1	04E04-391	Swivel Set, CO ₂ x 1/4" Barb	3.25	3.50	3.75	3.95
2	04C03-101	Tailpiece, 1/4" Barb	1.80	1.90	2.00	2.10
3	04E04-458	CO ₂ Nut Only	2.25	2.40	2.55	2.70
4	04E04-120	Female CO ₂ x 1/4" MFL	3.50	3.85	4.05	4.25
5	04E04-392	Male CO ₂ x 1/4" Barb	3.97	4.35	4.65	4.95
6	04C03-177	Male CO ₂ x 3/8" Barb	4.10	4.35	4.65	4.95
7	05C03-102	Male CO ₂ x 1/4 MPT	5.48	5.96	6.34	6.65
8	02H06-294	CO ₂ Washer Nylon	4.50	-	-	.10

Gas Cylinder Brackets

HEAVY DUTY 11 GAUGE STEEL • DURABLE POWDER COAT FINISH • STEEL REINFORCED VINYL EDGE GUARDING PROVIDES EXTRA GRIP AND HELPS PREVENT DAMAGE TO CYLINDERS • MOUNTS TO MOST FLAT SURFACES STRAPS ARE 1-1/2" WIDE X 54" LONG WITH A STEEL CINCH BUCKLE RATED AT 1100 PSI



20F05-103 (TRIPLE) 2" H x 4" W x 37" L
6+ **\$69.95** 3+ \$73.95 Ea. \$76.95



20F05-102 (DOUBLE) 2" H x 4" W x 24" L
6+ **\$57.95** 3+ \$60.95 Ea. \$63.95



FOR
5LB / 10LB / 20LB
CYLINDERS

8-1/2" W x 8-3/4" D x
18-1/2" H and
3" lip on the base

Mount anywhere at any height. The cylinder is supported by the base.

20F05-101 (SINGLE) 2" H x 4" W x 8" L
6+ **\$25.95** 3+ \$26.95 Ea. \$27.95



20F05-104 (SINGLE WITH BASE) 6+ **\$46.95** 3+ \$47.95 Ea. \$49.95

20F05-105
Replacement Strap
6+ **\$7.50**
3+ **\$7.95**
Ea. **\$8.50**



SELECTO
SCIENTIFIC

CO₂ Purification System

REMOVES ANY RESIDUAL TASTE AND ODOR FROM CO₂ GAS

ONE HIGH CAPACITY FILTER RUNS ALL YOUR BEVERAGE SYSTEMS!
PERFECT FOR EITHER BEER OR SODA APPLICATIONS.

SPECIFIED TO:

- Provide 100% 0.5-1 micron solid particulate reduction
- Provide 100% oil aerosols and vapor reduction at 61 mg/m³
- Increase carbonation

Flow Rate: 160 SCFM
Pressure Drop: 8 psi @ 160 SCFM @ 100 psi
Min./Max. Pressure: 40-125 psi
Min./Max. temp.: 40°-100° F
Inlet/Outlet Size: 1/2" Barb Standard

09S03-100

\$286.95

Replacement Cartridge 09S03-101 **\$192.95**



Quick-Fill CO₂ Connectors

ADD TO END OF FILL HOSE FOR EASY CONNECTION TO CO₂ TANKS WITHOUT A WRENCH
EXTENDED LENGTH ALLOWS EASY CONNECTION ON TANKS WITH A CARRY HANDLE



02C06-101
2-1/2" diameter grip wheel
Female CGA320 to Male CGA320
Male CGA320 can be removed to have 1/4" MPT

3+ \$64.95 Ea. \$67.95



04C07-116
Stainless steel ball valve
1000 psi working pressure.
1/4 turn, full port
\$15.95

1/4" FPT x 1/4" FPT



02H08-111
ABC Permanent O-ring

300+ **\$0.60** 100+ \$0.65
25+ \$0.70 Ea. \$0.75

Add an in-line shutoff to the quick-fill connector

Thread Protectors ALL PRICES PER 1,000

Fits all CO₂ tank valves. Eliminates cap and chain. Protects threads & holds washer.

Ref.#	Catalog No.	Description	10,000+	5,000+	2,500+	1,000+	500+
1	16H06-289	Thread Protector, Orange	48.95	51.95	53.95	56.95	63.00

Pilferage Protectors ALL PRICES PER 1,000

Inexpensive seal. Broken seal indicates use or pilferage. Also provides thread protection.

Ref.#	Catalog No.	Description	10,000+	5,000+	2,500+	1,000+	500+
2	16H06-306	Pilferage Protector, Blue	14.95	15.95	16.95	17.95	20.00
2	16H06-307	Pilferage Protector, Orange	14.95	15.95	16.95	17.95	20.00

Caution Labels (CO₂ & Blended Gas) ALL PRICES PER 1,000

Self-adhesive and durable. 5-1/4" long x 1-3/4" high.

REQUIRED BY U.S. TRANSPORTATION DEPT. FOR INTERSTATE SHIPMENTS.

Ref.#	Catalog No.	Description	4,000+	2,000+	1,000+	500+	250+	
3	16H06-293	Caution Label, CO ₂	73.00	75.00	77.00	80.00	84.00	
3	16H06-686	Above Label with Corp ID	CALL FOR PRICING					
3	16H06-295	Blended Gas (25% CO ₂ /75% N ₂)	76.00	78.00	80.00	82.00	84.00	

CO₂ Tag ("Full/In Use/Empty") ALL PRICES PER 1,000

Perforated beverage stock with mylar reinforced back side.

Ref.#	Catalog No.	Description	6,000+	4,000+	2,000+	1,000+	500+
4	16H06-687	CO ₂ Tag (2-3/8" x 5")	40.95	41.95	42.95	44.95	46.95



① Thread Protector
② Pilferage Protectors (Blue and Orange)
③ CAUTION LABEL FOR CO₂
④ CAUTION LABEL FOR BLENDED GAS
⑤ CARBON-DIOXIDE EMPTY IN USE FULL TAG

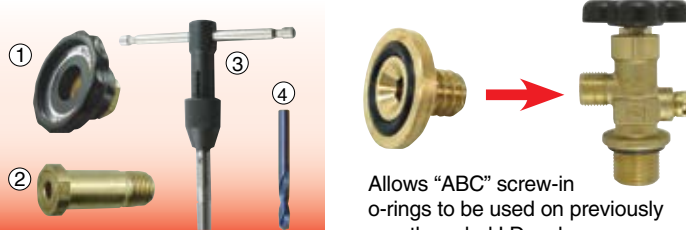

① O-ring
② ABC screw-in o-ring
③ Drill Guide
④ Tap Handle & Thread Tap
⑤ Drill Bit

Allows "ABC" screw-in o-rings to be used on previously non-threaded I.D. valves.

"ABC" O-Ring Conversion Kit

Ref. #	Catalog No.	Description	Each
1-4	20H08-115	Conversion Kit (complete)	67.95
1	20H08-105	Grip Wheel (only)	14.95
2	02A03-102	Drill Guide (only)	2.25
3	20B18-102	Tap Handle & Thread Tap (only)	45.95
4	20H08-102	Drill Bit (only)	3.95

Sherwood Valves for Aluminum Cylinders

GV SERIES VALVES ARE MANUFACTURED WITH A DURABLE FORGED BRASS BODY AND PRECISELY MACHINED INTERNAL COMPONENTS TO PROVIDE YEARS OF TROUBLE FREE SERVICE



FITS
2-1/2 LB.
TANK

02F08-127
CO₂ .750" UNF
25+ **\$18.95**
Ea. \$19.95



FITS
5 TO 50 LB.
TANKS

02F08-104
CO₂ 1.125" UNF
25+ **\$17.95**
Ea. \$19.95



FITS
5 TO 50 LB.
TANKS

02F08-124
N₂ 1.125" UNF
25+ **\$22.95**
Ea. \$23.95



CO₂ Cylinders and Accessories

Sherwood Valves for Steel Cylinders

GV SERIES VALVES ARE MANUFACTURED WITH A DURABLE FORGED BRASS BODY AND PRECISELY MACHINED INTERNAL COMPONENTS TO PROVIDE YEARS OF TROUBLE FREE SERVICE



02F08-129
CO₂ .50" NGT
25+ **\$19.95**
Ea. \$20.95



02F08-128
CO₂ .750" NGT
25+ **\$14.95**
Ea. \$15.95

OVERSIZED
THREAD
VALVES
ARE
AVAILABLE
UPON
REQUEST



02F08-130
CO₂ 1" NGT
25+ **\$20.95**
Ea. \$21.95



02F08-105
N₂ .750" NGT
25+ **\$15.50**
Ea. \$15.95

Steel Cylinder Valves

Aluminum Cylinder Valves



Stand valve on proper ring to determine size



Steel Cylinder Size	Thread Size
2-1/2#, 5#, 10#	1/2"
20#, 30#	3/4"
50#	1"

Aluminum Cylinder Size	Thread Size
2-1/2#	.750"
All other CO ₂	1.125"

Complete Valve Replacement Parts

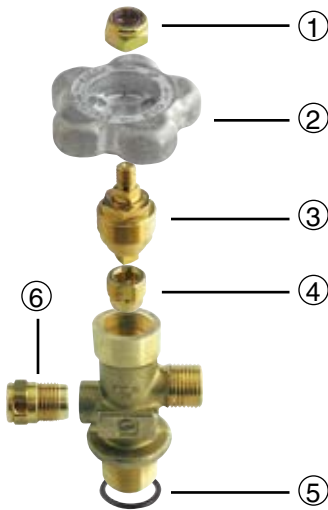

Sherwood

GV Series

CGA320 & CGA580

NEWEST MODEL VALVES

Ref. #	Catalog No.	Description	100+	50+	25+	10+	Each
1	02F08-131	Handwheel Nut	0.30	0.35	0.40	0.45	0.51
2	02F08-132	Handwheel (metal)	1.67	1.74	1.82	1.93	2.03
3	02F08-133	Bonnet/Stem Assembly	–	–	7.95	8.95	9.95
4	02F08-134	Plug/Seat Assembly	–	–	3.82	4.06	4.26
5	02F05-114	O-ring (fits 1.125 UNF)	0.06	0.07	0.08	0.10	0.15
5	02F05-109	O-ring (fits .750 UNF)	0.10	0.11	0.12	0.13	0.15
6	02F08-135	Safety Plug (3000 psi)	1.96	2.03	2.12	2.24	2.38
6	02F08-136	Safety Plug (3360 psi)	1.96	2.03	2.12	2.24	2.38

Additional price breaks available on most items. Login to your website account or contact your sales representative for pricing.



Sherwood

TV & MV Series

CGA320 & CGA580

OLDER MODEL VALVES

PARTS NOT LISTED FOR MV SERIES HAVE BEEN DISCONTINUED BY MFG

TV Series Valves				
Ref. #	Catalog No.	25+	10+	Each
1	02F08-114	2.81	2.97	3.16
2	02F08-122	2.37	2.50	2.66
3	02F08-123	3.43	3.63	3.86
4	02F08-110	1.18	1.25	1.33
5	02F08-126	CLOSEOUT	6.95	
6	02F08-106	0.27	0.28	0.30
7	02F08-107	CLOSEOUT	5.95	
8	02F08-108	CLOSEOUT	4.95	
9	02F05-114	0.08	0.10	0.15
9	02F05-109	0.12	0.13	0.15
10	02J05-107	4.45	4.71	5.00

Description	
Handwheel Nut	
Spring	
Handwheel (Metal)	
Gasket	
Bonnet	
Teflon Packing	
Stem Assembly	
Plug/Seat Assembly	
O-Ring (fits 1.125 UNF)	
O-Ring (fits .750 UNF)	
Safety Cap (3000 psi)	

MV Series Valves				
Ref. #	Catalog No.	25+	10+	Each
1	02F08-114	2.81	2.97	3.16
2	02F08-122	2.37	2.50	2.66
3	02F08-123	3.43	3.63	3.86
4	02F08-110	1.18	1.25	1.33
5	–	–	–	–
6	–	–	–	–
7	–	–	–	–
8	–	–	–	–
9	02F05-114	0.08	0.10	0.15
9	02F05-109	0.12	0.13	0.15
10	02J05-107	4.45	4.71	5.00

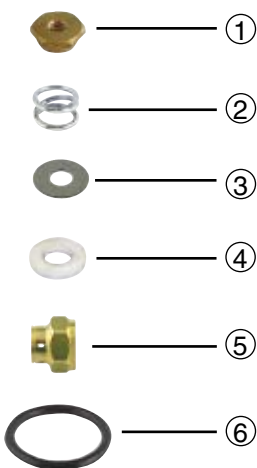
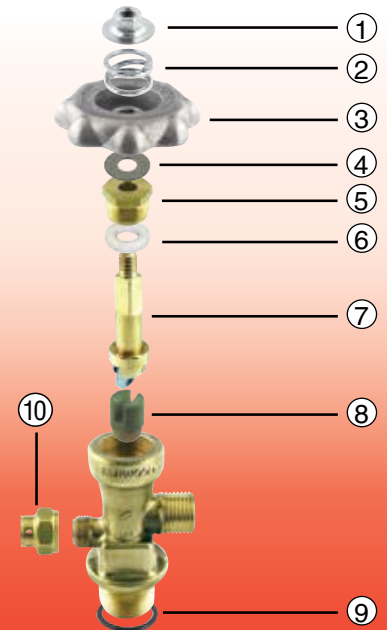

Superior 1100 & 1200 Series

CGA320 & CGA580

OLDEST MODEL VALVES

PARTS NOT LISTED HAVE BEEN DISCONTINUED BY MFG

1100 Series					1200 Series					
Ref. #	Catalog No.	25+	10+	Each	Description	Ref. #	Catalog No.	25+	10+	Each
1	–	–	–	–	Handwheel Nut	1	02J05-110	CLOSEOUT	–	2.95
2	02J05-111	2.31	2.45	2.57	Spring	2	02J05-111	2.31	2.45	2.57
3	02J05-112	CLOSEOUT	.25		Gasket	3	02J05-112	CLOSEOUT	.25	
4	02J05-109	0.27	0.28	0.30	Teflon Packing	4	02J05-109	0.27	0.28	0.30
5	02J05-107	4.45	4.71	5.00	Safety Cap (3000 psi)	5	02J05-107	4.45	4.71	5.00
6	02F05-114	0.08	0.10	0.15	O-Ring (fits 1.125 UNF)	6	02F05-114	0.08	0.10	0.15
6	02F05-109	0.12	0.13	0.15	O-Ring (fits .750 UNF)	6	02F05-109	0.12	0.13	0.15



A.E.B. Stainless Steel "Ball Lock" Product Tanks

FOR OVER 20 YEARS, A.E.B. HAS BEEN A WORLD LEADER IN THE PRODUCTION OF STAINLESS STEEL PRODUCT TANKS AND KEGS, AND THEY ARE ALSO ISO 9001 CERTIFIED

ATTENTION

FOXX NOW OFFERS INCREDIBLE DEALS ON MULTI-PALLET ORDERS

(5 gal = 50/pallet; 2.5 & 3 Gal = 80/pallet)

AND

20' CONTAINER ORDERS

(MIN. 900 TANKS to MAX. 1,500 TANKS)

(5 gal = 900 tanks; 3 gal = 1,300 tanks;
2.5 gal = 1,500 tanks; mixed sizes order = call)

CONTACT YOUR SALES REPRESENTATIVE FOR PRICING AND DETAILS

ALL PRODUCT TANKS ARE INDIVIDUALLY BOXED

- Manufactured of food grade 304 stainless steel
- Sanitary robotic welded seams are uniform and provide a leak-free seal that is free from deposits and debris
- Each tank is etched with A.E.B. logo, "Made in Italy," serial number, part number, mfg. date and NSF logo



PRODUCT TESTING AND CERTIFICATION FOR QUALITY



MADE IN ITALY



5 GALLON (8.5" diameter x 25" height)

15C07-124
50+ **\$78.95**
25+ \$81.95
10+ \$84.95
5+ \$88.95
Ea. \$91.95

15C07-224
50+ **\$83.95**
25+ \$86.95
10+ \$90.95
5+ \$93.95
Ea. \$97.95

NOTE: Rubber tops are stackable



3 GALLON (8.5" diameter x 16.75" height)

15C07-121
50+ **\$76.95**
25+ \$79.95
10+ \$82.95
5+ \$85.95
Ea. \$89.95

15C07-221
50+ **\$80.95**
25+ \$83.95
10+ \$86.95
5+ \$90.95
Ea. \$94.95

2.5 GALLON (8.5" diameter x 14.75" height)

15C07-119
50+ **\$74.95**
25+ \$76.95
10+ \$79.95
5+ \$83.95
Ea. \$86.95

15C07-219
50+ **\$76.95**
25+ \$79.95
10+ \$82.95
5+ \$86.95
Ea. \$89.95

Product Tanks and Parts



PALLET PRICES AVAILABLE
CALL FOR DETAILS



10 GALLON
12.25" dia. x 25.25" ht.



15 GALLON
12.25" dia. x 35.25" ht.



Challenger VI "Ball-Lock" Product Tanks

- Manufactured of corrosion resistant stainless steel
- TIG welded with complete penetration on all welds providing a uniform, leaf-free seal
- NSF approved, means tanks meet the standards of a trusted US government agency
- Scale and contaminants are removed through the process of pickling and passivation
- Etched/stamped with all compliant warnings, P/N, NSF logo and the words Sharpsville and Challenger

Catalog No.	Description	8+	4+	Each
15D04-126	10 Gallon Product Tank	290.95	298.95	309.95
15D04-127	15 Gallon Product Tank	374.95	384.95	399.95

Carbonate/Nitrogenate Lid

ADD TO ANY PRODUCT TANK TO EFFECTIVELY CARBONATE / NITROGENATE PRODUCTS



FITS MOST BRANDS OF PRODUCT TANKS

WORKS WITH:
2.5 gallon
3 gallon
5 gallon

Catalog No.	Description	25+	10+	5+	Each
15D04-100	Carb / Nitro Lid	35.95	37.95	39.95	41.95

O-Rings for Tank Plugs



FITS: BALL-LOCK PLUGS PRICES PER HUNDRED

Catalog No.	Description	1,000+	500+	100+	Each
15H06-295	Black	7.38	7.69	8.53	15.00
15H06-296	Blue	9.01	9.39	10.42	15.00
15H06-297	Green	9.01	9.39	10.42	15.00
15H06-298	Red	9.01	9.39	10.42	15.00
15H06-299	Yellow	9.01	9.39	10.42	15.00

FITS: PIN-LOCK PLUGS PRICES PER HUNDRED

Catalog No.	Description	1,000+	500+	100+	Each
15H06-300	Black	12.39	12.91	13.48	20.00
15H06-301	Blue	12.39	12.91	13.48	20.00
15H06-302	Green	12.39	12.91	13.48	20.00
15H06-303	Red	12.39	12.91	13.48	20.00
15H06-304	Yellow	12.39	12.91	13.48	20.00

Product Tank Jumpers

FOR CONNECTING MULTIPLE PRODUCT TANKS IN A SERIES — 1 JUMPER PER EACH ADDITIONAL TANK IS REQUIRED

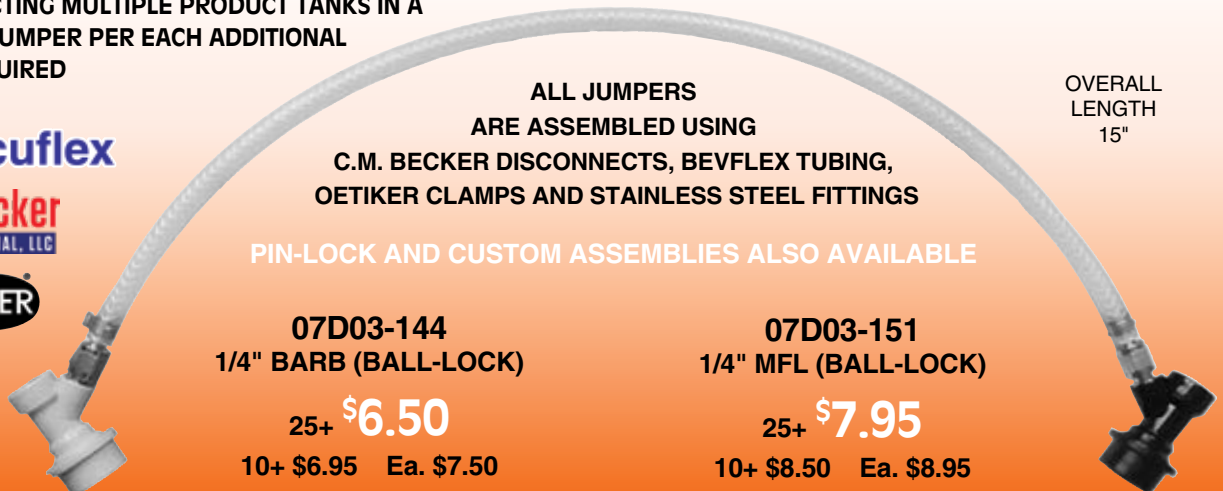

ALL JUMPERS

ARE ASSEMBLED USING

C.M. BECKER DISCONNECTS, BEVFLEX TUBING, OETIKER CLAMPS AND STAINLESS STEEL FITTINGS

OVERALL LENGTH
15"

PIN-LOCK AND CUSTOM ASSEMBLIES ALSO AVAILABLE

07D03-144

1/4" BARB (BALL-LOCK)

25+ **\$6.50**

10+ \$6.95 Ea. \$7.50

07D03-151

1/4" MFL (BALL-LOCK)

25+ **\$7.95**

10+ \$8.50 Ea. \$8.95



A.E.B. Product Tank Parts

Product Tanks and Parts



①
5 GALLON
LIQUID
DIP TUBE
BALL-LOCK



②
3 GALLON
LIQUID
DIP TUBE
BALL-LOCK



③
2.5 GALLON
LIQUID
DIP TUBE
BALL-LOCK



④
GAS
DIP TUBE
BALL-LOCK



⑤
GAS PLUG
BALL-LOCK
19/32"-18



⑥
LIQUID PLUG
BALL-LOCK
19/32"-18

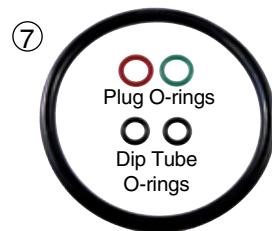

⑦

Plug O-rings
Dip Tube
O-rings

O-RING
REPLACEMENT
KIT



⑧
COMPLETE
LID ASSEMBLY
MFG. BY A.E.B.



⑨

SOFTER
BROWN
VERSION NOW
AVAILABLE FOR
HARD-TO-SEAL
TANKS

CLOSURE
O-RING
FOR ALL LIDS



⑩

DIP TUBE
O-RING



⑪



HANDLE
CAP
FOR A.E.B.



⑫

MANUAL
RELIEF
PULL RING



⑬

MANUAL RELIEF
FOR BALL-LOCK
TANKS



⑭

POPPET
(O.E.M. PART)



⑮

POPPET
(UNIVERSAL)

Additional price breaks available on most items. Login to your website account or contact your sales representative for pricing.

Ref. #	Catalog No.	Description	100+	50+	25+	Each
1	15C07-202	Dip Tube, 5 gallon (liquid)	3.95	4.50	5.95	6.50
2	15C07-201	Dip Tube, 3 gallon (liquid)	2.95	3.95	4.95	5.95
3	15C07-200	Dip Tube 2.5 gallon (liquid)	2.95	3.50	3.95	4.95
4	15C07-111	Dip Tube (gas)	1.20	1.25	1.35	1.40
5	15C07-115	Tank Plug, Ball-Lock (gas)	5.77	6.34	6.83	7.28
6	15C07-116	Tank Plug, Ball-Lock (liquid)	5.77	6.34	6.83	7.28
7	15D03-005	O-ring Replacement Kit	0.95	-	-	1.00
8	15D04-117	Complete Lid Assembly (A.E.B.)	13.65	14.20	15.00	15.95

Ref. #	Catalog No.	Description	300+	100+	50+	Each
9	15E02-103	Closure O-ring, Black-Std. (Univ.)	0.58	0.62	0.66	0.84
915E02-203	15E02-203	Closure O-ring, Brown-Soft (Univ.)	0.58	0.62	0.66	0.84
10	15C07-104	Dip Tube O-ring	0.04	0.05	0.06	0.10
11	15C07-118	Handle Cap (fits A.E.B. lid)	0.15	0.17	0.19	0.25
12	15C07-099	Pull ring (manual relief)	0.88	0.93	0.99	1.04
13	15C07-100	Manual Relief	2.85	2.95	3.25	3.50
14	15C07-101	Poppet (O.E.M. part)	1.85	2.00	2.25	2.50
15	15G04-200	Poppet (Universal)	0.62	0.66	0.72	0.83

Cornelius Product Tank Parts

Product Tanks and Parts



CORNELIUS PLUGS ARE NO LONGER AVAILABLE. In order to replace these, you will need to use the A.E.B. Plug and Poppet. Used together, these fit and work with the Cornelius tanks.



COMPLETE LID ASSEMBLY
MFG. BY A.E.B.

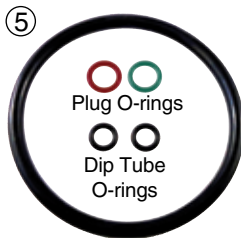

O-RING REPLACEMENT KIT



GAS DIP TUBE (UNIVERSAL)



CLOSURE O-RING (UNIVERSAL)



DIP TUBE O-RING (UNIVERSAL)



MANUAL RELIEF FOR BALL-LOCK TANKS



AUTO RELIEF FOR PIN-LOCK TANKS



POPPET (CORNELIUS)



POPPET (UNIVERSAL)



HANDLE CAP FOR CORNELIUS LIDS ONLY



MANUAL RELIEF PULL RING

Additional price breaks available on most items. Login to your website account or contact your sales representative for pricing.

BALL-LOCK PARTS

Ref. #	Catalog No.	50+	25+	Each	Description
1	15C07-201	3.95	4.95	5.95	Dip tube, 3 gallon (liquid)
2	15C07-129	7.95	8.50	8.95	Dip tube, 5 gallon (Spartan)
3	15C07-202	4.50	5.95	6.50	Dip tube, 5 gallon (liquid)
4	15D04-117	14.20	15.00	15.95	Complete Lid Assembly (A.E.B.)
5	15D03-005	0.90	0.95	1.00	O-ring Replacement Kit
6	15C07-111	1.25	1.35	1.40	Dip tube (gas)

PIN-LOCK PARTS

Catalog No.	100+	50+	25+	Each
15C07-201	3.95	4.95	5.95	
15C07-129	7.95	8.50	8.95	
15C07-152	9.27	9.82	10.43	
15D04-117	14.20	15.00	15.95	
15D03-006	-	-	1.10	
15C07-111	1.25	1.35	1.40	

Ref. #	Catalog No.	100+	50+	Each	Description	Catalog No.	100+	50+	Each
7	15E02-103	0.62	0.66	0.84	Closure O-ring, Black-Std (Univ.)	15E02-103	0.62	0.66	0.84
7	15E02-203	1.45	1.55	1.75	Closure O-ring, Brown-Soft (Univ.)	15E02-203	1.55	1.55	1.75
8	15C07-104	0.05	0.06	0.10	Dip Tube O-ring	15C07-104	0.06	-	0.10
9	15C07-100	2.95	3.25	3.50	Relief Valve	15C07-109	-	-	-
10	15C07-105	2.95	3.50	3.95	Poppet (Cornelius)	15C07-105	2.95	3.50	3.95
11	15G04-200	0.66	0.72	0.83	Poppet (Universal)	15G04-200	0.66	0.72	0.83
12	15C07-117	0.41	0.45	0.60	Handle Cap (fits Cornelius lid)	15C07-117	0.41	0.45	0.60
13	15C07-099	0.93	0.99	1.04	Pull Ring (manual relief)	-	-	-	-

Firestone and John Wood Product Tank Parts

Product Tanks and Parts

FITS FIRESTONE MODELS:

Challenger V
Challenger VI
Super Challenger

FITS FIRESTONE MODEL:

Challenger

FITS JOHN WOOD MODEL:

85

FITS FIRESTONE MODELS:

A or R

FITS JOHN WOOD MODELS:

RA or RC

①



GAS PLUG
BALL-LOCK
9/16"-18

②



LIQUID PLUG
BALL-LOCK
10/16"-18

③



GAS PLUG
BALL-LOCK
11/16"-18

④



LIQUID PLUG
BALL-LOCK
12/16"-18



⑤

⑥



GAS PLUG
PIN-LOCK
9/16"-18

SOLD
AS A
SET



LIQUID PLUG
PIN-LOCK
9/16"-18

ALL PLUGS INCLUDE
POPPET AND O-RING

ALL PLUGS INCLUDE
POPPET AND O-RING

⑧



POPPET
(FIRESTONE)

OR

⑨



POPPET
(UNIVERSAL)

⑩



POPPET
(FIRESTONE)

OR

⑨



POPPET
(UNIVERSAL)

⑪



FITS
PIN-LOCK
PLUGS

POPPET
(FIRESTONE)

OR

⑨



POPPET
(UNIVERSAL)

⑫

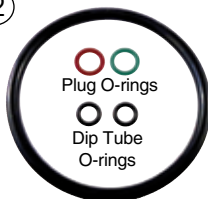

O-RING
REPLACEMENT KIT
FOR PRODUCT
TANKS

⑬



CLOSURE O-RING
FITS ALL LIDS
INCLUDING
RACE TACK LID

⑭



DIP TUBE
O-RING
OR
GASKET

RELIEF VALVE
WITH JAM NUT



15C07-108
25+ \$7.50
10+ \$7.95
EA. \$8.25

⑮



COMPLETE LID
ASSEMBLY
DOES NOT REPLACE
RACE TRACK STYLE LID

⑯



GAS
DIP TUBE
FOR 3 & 5
GALLON

Additional price breaks available on most items. Login to your website account or contact your sales representative for pricing.

Ref.#	Catalog No.	Description	50+	25+	Each
1	15E04-301	Tank Plug, Ball-Lock (gas)	10.17	10.91	11.41
2	15E04-305	Tank Plug, Ball-Lock (liquid)	9.01	9.66	10.10
Ref.#	Catalog No.	Description	25+	10+	Each
3	15E04-299	Tank Plug, Ball-Lock (gas)	14.81	15.85	16.63
4	15E04-303	Tank Plug, Ball-Lock (liquid)	12.50	13.28	13.98
5	15E04-190	Plastic Insert (only)	0.89	0.95	1.00
Ref.#	Catalog No.	Description	100+	50+	Each
6	15G04-100	Conversion Plug Set, Ball-Lock	7.95	8.95	9.95
8	15E04-272	Poppet (Firestone Ball-Lock)	2.78	2.94	3.12
9	15G04-200	Poppet (Universal)	0.66	0.72	0.83

Ref.#	Catalog No.	Description	100+	50+	Each
10	15E04-227	Poppet (Firestone Ball-Lock)	2.20	2.36	2.51
11	15E04-228	Poppet (Firestone Pin-Lock)	3.62	3.83	4.07
12	15D03-005	O-ring Kit (Ball-Lock)	0.95	0.95	1.00
12	15D03-006	O-ring Kit (Pin-Lock)	1.05	0.95	1.10
13	15E02-103	Closure O-ring, Black Std (Univ.)	0.62	0.66	0.84
13	15E02-203	Closure O-ring, Brown-Soft (Univ.)	1.45	1.55	1.75
14	15D04-121	Dip Tube Gasket (Ball-Lock)	0.15	0.15	0.20
14	15E02-102	Dip Tube O-ring (Pin-Lock)	0.08	0.10	0.15
Ref.#	Catalog No.	Description	50+	25+	Each
15	*15D04-117	Complete Lid Assembly (A.E.B)	14.20	15.00	15.95
16	*15C07-111	Dip Tube (gas)	1.25	1.35	1.40

Product Tank Conversion Plugs

REPLACE THE EXISTING PLUGS ON A STAINLESS STEEL PRODUCT TANK WITH CONNECTIONS SHOWN

Fits Cornelius and A.E.B.

Ball-Lock or Pin-Lock 19/32"-18 UNF



DISCONTINUED LIMITED STOCK

①



DISCONTINUED LIMITED STOCK

②



③



DISCONTINUED LIMITED STOCK

Fits Firestone

Ball-Lock Tanks



④

Pin-Lock Tanks



304 S/S
ADDITIONAL PRICE BREAKS AVAILABLE

⑤

Ref. #	Catalog No.	Description	50+	25+	10+	Each
1	04C03-319	1/4" MPT (Gas & liquid)	4.35	4.65	4.95	5.25
2	04C03-321	1/4" MFL (Gas & liquid)	LIMITED STOCK			3.95
3	04C03-322	3/8" MFL (Gas & liquid)	LIMITED STOCK			4.95

Ref. #	Catalog No.	Description	50+	25+	10+	Each
4	04C03-342	1/4" MPT x 10/16"-18 (Liquid)	LIMITED STOCK			5.95
5	15G04-100	Ball-Lock (set) 9/16"-18	6.95	7.95	8.95	9.95

"Pin Lock" Socket

Designed for quick and easy removal/installation of pin lock plugs.



3/8" DRIVE (Ratchet not included)

15E04-205

50+ **\$8.95**

25+ \$9.95 10+ \$10.95 Ea. \$11.95

Depressurizer

For pin-lock plugs



15A01-135

Ea. **\$1.95**

S/S Tank Nipple

Has 19/32"-18 thread and accepts the A.E.B. & Cornelius plugs



Requires a 9/16" diameter hole for weld

WELD IN PLACE FITTING

15C07-103

50+ **\$2.25**

25+ \$2.50 Ea. \$2.95

Additional price breaks available on most items. Login to your website account or contact your sales representative for pricing.

Adapters for Product Tank Plugs

ALLOWS PLUGS REMOVED FROM PRODUCT TANKS TO BE USED FOR OTHER PURPOSES

Fits Cornelius and A.E.B.

Ball-Lock or Pin-Lock Plugs



FEMALE FLARE



MALE PIPE THREAD

Fits Firestone

Ball-Lock Plugs



FEMALE FLARE



DISCONTINUED LIMITED STOCK



FEMALE PIPE THREAD



DISCONTINUED LIMITED STOCK



MALE PIPE THREAD

FITS 15C07-115 & 15C07-116 GAS & LIQUID PLUGS USE THE SAME ADAPTER		
Catalog No.	Converts to	Each
04C03-317	1/4" FFL	3.95
04C03-365	1/4" MPT	3.95
07E04-383	O-ring (replacement)	0.27

FITS 15E04-301 & 15E04-305 GAS & LIQUID PLUGS USE DIFFERENT ADAPTERS		
Catalog No.	Converts to	Each
15E04-451	1/4" FFL Gas LIMITED STOCK	3.95
15E04-454	1/4" FFL Liquid LIMITED STOCK	3.95
*15E04-450	1/4" FPT Gas	10.51
*15E04-456	1/4" FPT Liquid	11.80

FITS 15E04-301 & 15E04-305 GAS & LIQUID PLUGS USE DIFFERENT ADAPTERS		
Catalog No.	Converts to	Each
15E04-449	1/4" MPT Gas	3.95
*15E04-452	3/8" MPT Gas	9.68
07E04-383	O-Ring (replacement)	0.27



Economy Stainless Steel Disconnects



07C04-294 (Gas 1/4" MFL)
50+ **\$12.95**
25+ \$13.95 Ea. \$14.95

Attach any Swivel Nut & Stem to create a Barbed Version (See page 94)



07C04-295 (Liquid 1/4" MFL)
50+ **\$12.95**
25+ \$13.95 Ea. \$14.95



EATON Stainless Steel Disconnects

Disconnect Check Valve



1/4" FFL x 1/4" MFL
04C03-229
\$6.95



BALL LOCK
07E04-294 (Gas 1/4" MFL)
07E04-295 (Liquid 1/4" MFL)
50+ **\$27.95**
25+ \$28.95 Ea. \$29.95



BALL LOCK
07E04-297 (Gas 1/4" Barb)
07E04-298 (Liquid 1/4" Barb)
50+ **\$27.95**
25+ \$28.95 Ea. \$29.95

Additional price breaks available on most items. Login to your website account or contact your sales representative for pricing.

Disconnects with Integrated Back Check Valve

PIN-LOCK



07C07-114
25+ **\$9.50**
10+ \$9.95
Ea. \$10.50

1/2"-16 MFL



MADE IN GERMANY



ASSEMBLED IN AMERICA

BALL-LOCK



07C07-113
25+ **\$9.50**
10+ \$9.95
Ea. \$10.50

1/4" MFL

Product Tanks and Parts



Plastic Ball-Lock Disconnects

HIGH QUALITY • MADE IN GERMANY / ASSEMBLED IN AMERICA • NSF LISTED



CMBecker
INTERNATIONAL, LLC

1/4" BARB

07C07-138 (GAS-Gray)
07C07-139 (LIQUID-Blk)

100+ **\$2.60**
50+ \$2.65
Ea. \$2.80

CMBecker
INTERNATIONAL, LLC

3/8" BARB

07C07-165 (GAS-Gray)
07C07-166 (LIQUID-Blk)

100+ **\$3.40**
50+ \$3.55
Ea. \$3.70

CMBecker
INTERNATIONAL, LLC

1/4" MFL

07C07-115 (GAS-Gray)
07C07-116 (LIQUID-Blk)

100+ **\$2.60**
50+ \$2.65
Ea. \$2.80

Additional price breaks available on most items. Login to your website account or contact your sales representative for pricing.

Plastic Pin-Lock Disconnects (Short Version)

HIGH QUALITY • MADE IN GERMANY / ASSEMBLED IN AMERICA • NSF LISTED



CMBecker
INTERNATIONAL, LLC

1/4" BARB

07C07-146 (GAS-Gray)
07C07-147 (LIQUID-Blk)

100+ **\$3.00**
50+ \$3.10
Ea. \$3.20

CMBecker
INTERNATIONAL, LLC

3/8" BARB

07C07-169 (GAS-Gray)
07C07-170 (LIQUID-Blk)

100+ **\$3.40**
50+ \$3.55
Ea. \$3.70

CMBecker
INTERNATIONAL, LLC

1/4" MFL

07C07-148 (GAS-Gray)
07C07-149 (LIQUID-Blk)

100+ **\$3.00**
50+ \$3.10
Ea. \$3.20

Plastic Pin-Lock Barbed Disconnects (Tall Version)

HIGH QUALITY • MADE IN GERMANY / ASSEMBLED IN AMERICA • NSF LISTED



1/4" BARB
07C07-142 (GAS-Gray)
07C07-143 (LIQUID-BIK)

100+ **\$3.00**
 50+ **\$3.10**
 Ea. **\$3.20**



3/8" BARB
07C07-167 (GAS-Gray)
07C07-168 (LIQUID-BIK)

100+ **\$3.50**
 50+ **\$3.65**
 Ea. **\$3.80**



Additional price breaks available on most items. Login to your website account or contact your sales representative for pricing.

Plastic Pin-Lock Male Flare Disconnects (Tall Version)

HIGH QUALITY • MADE IN GERMANY / ASSEMBLED IN AMERICA • NSF LISTED



1/4" MFL
07C07-144 (GAS-Gray)
07C07-145 (LIQUID-BIK)

100+ **\$3.00**
 50+ **\$3.10**
 Ea. **\$3.20**



1/2"-16 MFL
07C07-140 (GAS-Gray)
07C07-141 (LIQUID-BIK)

100+ **\$3.50**
 50+ **\$3.65**
 Ea. **\$3.80**



CMBecker Plastic Disconnect Parts

Ref. #	Catalog No.	Description	100+	50+	25+	Each
1	07C07-150	Washer, Cap	0.13	0.15	0.16	0.17
2	07C07-154	Spring, Poppet	0.15	0.20	0.25	0.30
3	07C07-151	Poppet	0.68	0.72	0.77	0.80

BALL-LOCK CAPS

Ref. #	Catalog No.	Description	50+	25+	10+	Each
4	07C07-153	Cap, Gas (gray)	0.34	0.36	0.38	0.40
5	07C07-152	Cap, Liquid (black)	0.34	0.36	0.38	0.40

SHORT PIN-LOCK CAPS

Ref. #	Catalog No.	Description	50+	25+	10+	Each
6	07C07-156	Cap, Gas (gray)	0.34	0.36	0.38	0.40
7	07C07-155	Cap, Liquid (black)	0.34	0.36	0.38	0.40

TALL PIN-LOCK CAPS

Ref. #	Catalog No.	Description	50+	25+	10+	Each
8	07C07-158	Cap, Gas (gray)	0.38	0.41	0.43	0.45
9	07C07-157	Cap, Liquid (black)	0.38	0.41	0.43	0.45



5 Gallon Tank Insulator & Ice Blanket

MAINTAIN SERVING TEMPERATURE FOR UP TO 24 HOURS WHEN ICE BLANKET IS USED

Product Tank Accessories



AMERICAN MADE, USING ONLY THE HIGHEST QUALITY MATERIALS AND WORKMANSHIP TO ENSURE A DURABLE AND RELIABLE PRODUCT.

Manufactured from neoprene to prevent temperature escape.
Has an integrated internal pocket to house the ice blanket.
Used together, they will keep product cold for up to 24 hours.

Tank Insulator

15C07-160
25+ **\$25.95**
10+ **\$26.95**
5+ **\$27.95**
Ea. **\$28.95**



Ice Blanket

15C07-170
25+ **\$14.50**
10+ **\$14.95**
5+ **\$15.50**
Ea. **\$15.95**



Sanitary Caps for Ball-Lock & Pin-Lock Product Tanks

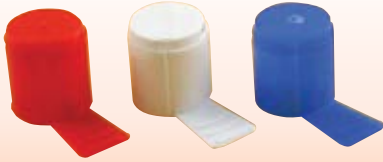

TAMPER EVIDENT Disposable Caps
Sold in bags of 1,000 pcs.
Factory Carton 5,000 pcs.
FOR BALL-LOCK ONLY

TAMPER EVIDENT CAPS				
Catalog No.	Description	10,000+	5,000+	1,000+
16H06-849	Red, Gas	19.95	21.95	24.95
16H06-850	White, Liquid	19.95	21.95	24.95
16H06-847	Blue, Gas	19.95	21.95	24.95



PRICED PER 1,000 ONE TRIP ONLY Disposable Caps
Sold in bags of 1,000 pcs.
Factory Carton 5,000 pcs.

"ONE TRIP ONLY" CAPS				
Catalog No.	Color	10,000+	5,000+	1,000+
16H06-527	Red	22.95	23.95	25.95
16H06-673	Green	22.95	23.95	25.95
16H06-495	Blue	22.95	23.95	25.95
16H06-494	Black	22.95	23.95	25.95
16H06-498	Clear	22.95	23.95	25.95
16H06-538	White	22.95	23.95	25.95
16H06-539	Yellow	22.95	23.95	25.95



FOR BALL-LOCK OR PIN-LOCK TANKS

Additional price breaks available on most items. Login to your website account or contact your sales representative for pricing.

Secur-A-Tie® Tamper Evident Fasteners

These 5" ties provide you with lowest unit cost for light duty tamper evident applications.
PRICED PER 1,000 / sold in bags of 1,000 pcs. Factory carton 5,000 pcs

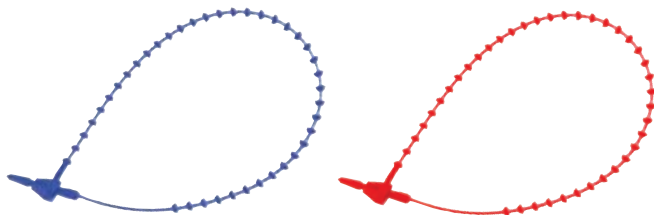

Catalog No.	Color	10,000+	5,000+	1,000+
16Z01-102	Blue	11.95	12.95	13.95
16Z01-108	Red	11.95	12.95	13.95

Bag 'N Box Racks



Heavy-duty steel construction with black powder-coat finish.

Stackable (stacker connectors & finish end-caps included)



15B09-200
1 Box Incline

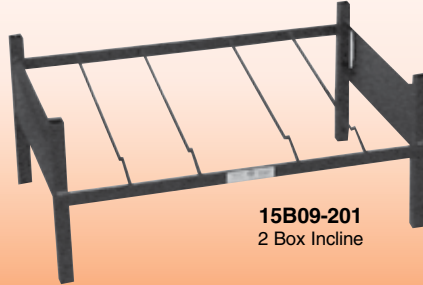

15B09-201
2 Box Incline

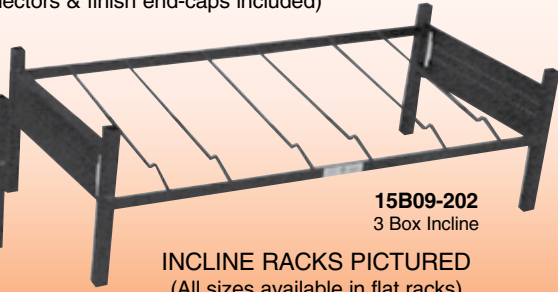

15B09-202
3 Box Incline

INCLINE RACKS PICTURED
(All sizes available in flat racks)

Incline Racks (General Beverage)

All racks 12" high and 17" deep

Catalog No.	Boxes	Width	12+	8+	4+	Each
15B09-200	1 Box	15"	22.95	23.95	24.95	26.95
15B09-201	2 Box	27"	24.95	25.95	26.95	28.95
15B09-202	3 Box	39"	32.95	34.95	36.95	38.95

Flat Racks (Coca Cola)

All racks 11" high and 17" deep

Catalog No.	Boxes	Width	12+	8+	4+	Each
15B09-250	1 Box	15"	22.95	23.95	24.95	26.95
15B09-251	2 Box	26"	24.95	25.95	26.95	28.95
15B09-252	3 Box	39"	32.95	34.95	36.95	38.95

Top Shelf for Bag 'N Box Racks

Heavy-duty steel construction with black powder-coat finish.

ALL SHELVES 8-1/2" HIGH



15F09-109
2 Box Top Shelf



Catalog No.	Boxes	Fits	4+	2+	Each
15F09-108	1 Box	Incline & Flat	32.95	33.95	35.95
15F09-109	2 Box	Incline	39.95	41.95	43.95
15F09-110	2 Box	Flat	39.95	41.95	43.95
15F09-111	3 Box	Incline & Flat	42.95	44.95	46.95

Top Pump Mount for Bag 'N Box Racks

Heavy-duty steel construction with black powder-coat finish

HOLDS UP TO 8 PUMPS



Fits
2 Box wide racks

Catalog No.	Boxes	Fits	Dimensions	4+	2+	Each
15F09-106	2 Box	Incline	27" W x 24" H	27.95	29.95	30.95
15F09-116	2 Box	Flat	28" W x 21" H	27.95	29.95	30.95

Additional price breaks available on most items. Login to your website account or contact your sales representative for pricing.

Bag 'N Box Accessories

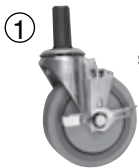

5" diagonal swivel wheel with toggle off/on brake



Ref.	Catalog No.	Description	8+	4+	Each
1	14C07-101	Swivel Caster	13.95	14.95	15.95
2	15F09-118	Leveler, 1/2" - 13/8"	4.00	4.25	4.50
Ref.	Catalog No.	Description	25+	10+	Each
3	15A01-102	Finish End Cap	0.08	0.09	0.10
4	15A01-100	Stacker/Connector	0.41	0.44	0.46

Preassembled Bag 'N Box Rack Systems

CUSTOM BUILT TO YOUR SPECIFICATIONS

THINGS WE NEED TO KNOW:

- The size and type of rack
- Quantity of racks per stack
- Brand, type and quantity of syrup pumps
- Style of bag connectors
- Brand of secondary regulator

ADDITIONAL OPTIONS

- Top Shelf
- Top Pump Mount
- Transfer Valves
- Casters
- Adjustable Levelers



Call Your Sales Representative for a Quote Today!



Syrup, Juice and Condiment Pumps

DESIGNED FOR DISPENSING BIB SYRUPS, WINES, TEAS, JUICES, MILK AND WATER

Shuts off automatically when bag is empty and restarts with a new bag



GAS OPERATED—RUNS ON CO₂, NITROGEN, OR COMPRESSED FILTERED AIR.
Handles 2 fast-flow or 4 regular faucets.
Complete with auto-sold-out.

SYRUP PUMPS

Guarantees a steady supply of soda syrup under pressure to a post-mix dispenser valve.

Quick disconnect fittings and snap-on bracket for ease of service.

JUICE PUMPS

A modified valve design allows the pumping of products containing soft solids up to .025" diameter.

For concentrates that are higher viscosity than soda syrups.

CONDIMENT PUMPS

A straight-through flow path allows more viscous and particulates to be pumped. Allows particles up to .25" cubed, assuring fewer restrictions.

Catalog No.	Description	Shurflo #	72+	36+	12+	Each
15C07-130	Syrup (1/4" S/S Barb liquid out)	166-296-07	35.95	37.95	39.95	41.95
15C07-149	Syrup (3/8" S/S Barb liquid out)	166-296-07	35.95	37.95	39.95	41.95
91C07-001	Syrup Service Pump (no fittings or bracket)	166-296-08	34.95	36.95	38.95	40.95
15C07-141	Mounting Bracket, Replacement (Snap-On)	94-467-00	1.35	1.40	1.50	1.60
HIGH ALTITUDE SYRUP PUMPS (FOR ELEVATIONS ABOVE 5000')						
15C07-180	Syrup (1/4" S/S Barb liquid out)	166-296-50	35.95	37.95	39.95	41.95
15C07-189	Syrup (3/8" S/S Barb liquid out)	166-296-50	35.95	37.95	39.95	41.95
JUICE PUMP (FOR BLOODY MARY, MARGARITA MIX, ETC.)						
15C07-132	Juice Pump (3/8" Plastic Barb liquid out)	166-296-18	38.95	40.95	42.95	45.95

Additional price breaks available on most items. Login to your website account or contact your sales representative for pricing.



Syrup Pump and Bracket Assemblies

DESIGNED FOR QUICK AND EASY INSTALLATION AND SERVICE

Specify 1/4" or 3/8" syrup outlets – custom assemblies also available

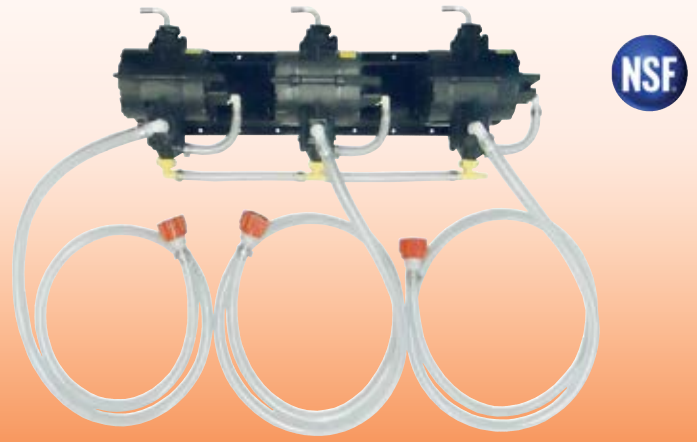
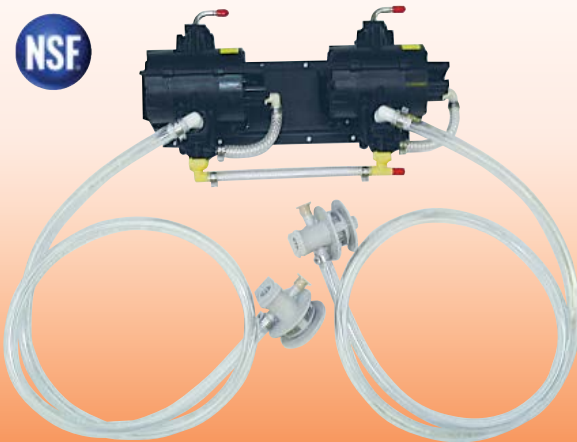

Catalog No.	Description	6+	3+	Each
15D03-115	2 Pump (General beverage)	124.95	129.95	136.95
15D03-116	2 Pump (Coca Cola)	121.95	125.95	132.95
15F09-100	Bracket Only (2 pump)	8.95	9.95	10.95

Catalog No.	Description	6+	3+	Each
15D03-105	3 Pump (General beverage)	184.95	191.95	202.95
15D03-106	3 Pump (Coca Cola)	179.95	186.95	196.95
15F09-101	Bracket Only (3 pump)	9.95	10.95	11.95



Brix Proportioning Pumps

DESIGNED FOR THE DISPENSING OF SYRUPS, JUICE AND MIX CONCENTRATES

EASILY ALLOWS CONCENTRATES WITH PULP, STRINGY PULP OR PARTICULATE TO FLOW THROUGH

The Brix pump is a proportioning device, which pumps two liquids (e.g. water and concentrate) in an exact ratio. The particular ration is determined by the pump design, and is thereby maintained precisely, independent of system flow or pressure changes, with no need to regularly readjust brix at the dispensing valve.

The pump operates on the source pressure of one of the liquids; typically the incoming water, eliminating the need for CO2 or electric power.

All brix pumps have a metal mounting bracket, 3-way sanitizing valve, and vacuum shut-off valve (sold out feature) which keeps the system primed when water or syrup flow stops.

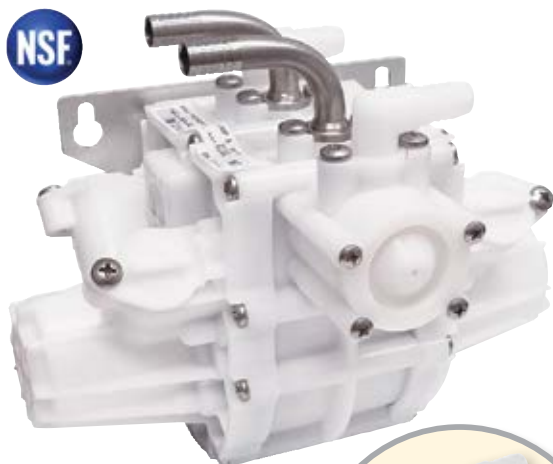

3-Way Sanitizing Valve Included – \$20 Added Value

Catalog No.	Description	8+	4+	Each
15C07-133	5:1 Proportion	173.95	179.95	187.95
15C07-135	4:1 Proportion	173.95	179.95	187.95
15C07-136	3:1 Proportion	173.95	179.95	187.95

Transfer Valve

Helps reduce sold outs by automatically switching from empty to full bag.



15C07-134
30+ \$18.95
15+ \$20.95
Ea. \$21.95

3-Way Sanitizing Valve

To facilitate "in-place" sanitizing of Shurflo Brix pumps. Used regularly, helps provide peak performance and reliability.



15C07-138
25+ \$28.95
10+ \$30.95
Ea. \$31.95

Vacuum Regulator

Permits the pumping of product from remote storage locations to the downstream brix pump.



15C07-153
Each \$15.95

Air Fittings for Gas Pumps

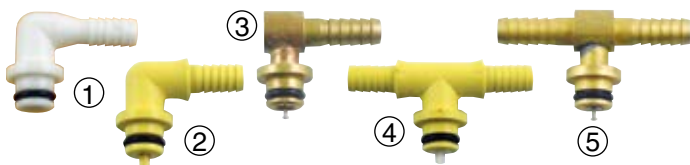

Liquid Fittings for Gas Pumps

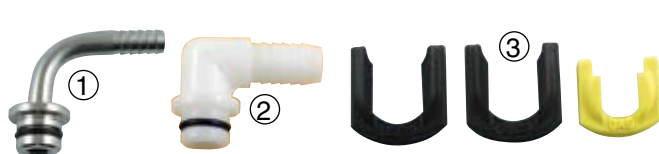

Additional price breaks available on most items. Login to your website account or contact your sales representative for pricing.

Ref.#	Catalog No.	Description	25+	10+	Each
1	05C07-109	Elbow, 1/4" B (plastic)	1.15	1.20	1.30
2	05C07-108	Elbow, 1/4" B w/shutoff (plastic)	1.15	1.20	1.30
3	05C07-144	Elbow, 1/4" B w/shutoff (brass)	1.61	1.71	1.79
4	05C07-106	Tee, 1/4" B w/shutoff (plastic)	2.10	2.25	2.35
5	05C07-145	Tee, 1/4" B w/shutoff (brass)	2.80	2.95	3.10

Ref.#	Catalog No.	Description	25+	10+	Each
1	04C07-103	Elbow 1/4" B (stainless steel)	1.45	1.54	1.62
1	04C07-104	Elbow 3/8" B (stainless steel)	1.40	1.50	1.60
2	05C07-107	Elbow 3/8" B (plastic)	0.60	0.65	0.75
2	05C07-111	Elbow 1/2" B (plastic)	2.10	2.20	2.40
3	15D03-131	3pc Clip set (1pc GAS & 2pc LIQUID)	0.92	0.97	1.05



Syrup or Juice & Condiment Pump

DESIGNED FOR DISPENSING BIB SYRUPS, WINES, TEAS, JUICES, MILK AND WATER

SHUTS OFF AUTOMATICALLY WHEN BAG IS EMPTY AND RESTARTS WITH A NEW BAG

Syrup Pumps – Flojet



GAS OPERATED—RUNS ON CO₂, NITROGEN OR COMPRESSED AIR
Flow rate - 4 oz. per second
Service life - up to 40,000 gallons



SYRUP PUMPS

Designed for dispensing BIB syrups, juices, teas, wines, etc. without pulp or particulate. Quick disconnect fittings and snap-on bracket for ease of service.



GAS OPERATED—RUNS ON CO₂, NITROGEN OR COMPRESSED AIR
Flow rate - 7 oz. per second
Service life - up to 100,000 gallons



JUICE & CONDIMENT PUMP

Designed for dispensing BIB syrups, juice concentrates and condiments which have pulp particulate or are highly viscous.

Ref	Catalog No.	Description	Flojet #	72+	36+	12+	Each
1	15F01-115	Syrup Pump (1/4" S/S Barb liquid out)	5000-140	37.95	39.95	41.95	45.95
1	15F01-215	Syrup Pump (3/8" S/S Barb liquid out)	5000-515	37.95	39.95	41.95	45.95
1	15F01-120	Syrup Service Pump (no fittings)	5000-135	31.95	33.95	35.95	39.95
2	15F01-125	Heavy Duty Syrup (1/4" S/S Barb liquid out)	G55-1012	50.95	53.95	56.95	61.95
HIGH ALTITUDE SYRUP PUMP (FOR ELEVATIONS ABOVE 5000')							
1	15F01-123	Syrup Pump (1/4" S/S Barb liquid out)	5000-153	37.95	39.95	41.95	45.95
JUICE/CONDIMENT PUMP (FOR JUICES WITH PULP OR PARTICULATES AND CONDIMENTS)							
2	15F01-126	Heavy duty Juice Pump (3/8" S/S Barb liquid out)	G-80E022A	54.95	57.95	61.95	67.95

Additional price breaks available on most items. Login to your website account or contact your sales representative for pricing.



Syrup Pump and Bracket Assemblies

DESIGNED FOR QUICK AND EASY INSTALLATION AND SERVICE

SPECIFY 1/4" OR 3/8" SYRUP OUTLETS – CUSTOM ASSEMBLIES ALSO AVAILABLE

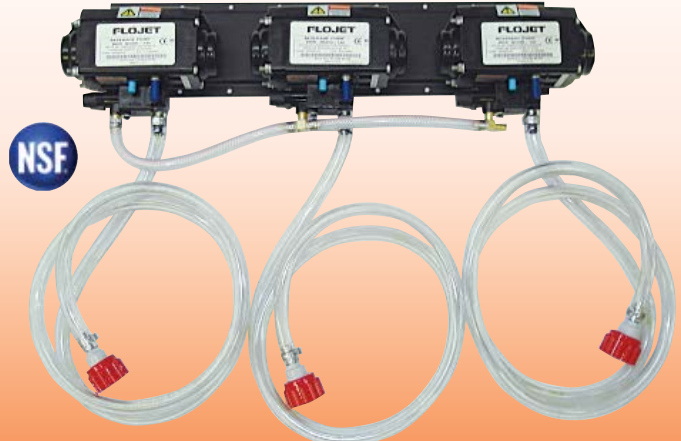

Catalog No.	Description	6+	3+	Each
15D03-117	2 Pump (General Beverage)	105.95	109.95	115.95
15D03-118	2 Pump (Coca Cola)	99.95	103.95	108.95
15F09-100	Bracket Only (2 pump)	8.95	9.95	10.95

Catalog No.	Description	6+	3+	Each
15D03-107	3 Pump (Gen Bev)	155.95	161.95	170.95
15D03-108	3 Pump (Coke)	146.95	151.95	160.95
15F09-101	Bracket Only (3 pump)	9.95	10.95	11.95



Electric B-I-B Demand Pump

DESIGNED FOR DISPENSING BIB SYRUPS, WINES, TEAS, JUICES, MILK AND WATER

SHUTS OFF AUTOMATICALLY WHEN BAG IS EMPTY AND RESTARTS WITH A NEW BAG

FOR APPLICATIONS WHERE CO₂ IS NOT AVAILABLE

- Can pump up to 50' horizontal with a 10' vertical rise
- Unit is self-priming and can run dry for extended periods of time
- Integral check valve maintains uniform pressure at the dispensing valve when pump is not running
- Operating pressure 45 PSI
- Flow Rate - 1 oz. per second



15F01-117

6+ **\$139.95**
3+ \$142.95 Ea. \$146.95

3/8" Barb fittings

Transfer Valve Regular



FLOJET

REGULAR 15F01-113

20+ \$20.95 10+ \$21.95 Ea. \$22.95

HIGH ALTITUDE 15F01-213

20+ \$24.95 10+ \$25.95 Ea. \$27.95

Transfer Valve 90° Swivel



FLOJET

REGULAR 15F01-112

20+ \$24.95 10+ \$25.95 Ea. \$27.95

HIGH ALTITUDE 15F01-212

20+ \$24.95 10+ \$25.95 Ea. \$27.95

Label indicates which BIB is on line

AUTO SWITCHING

Auto Shutoff - Input

FOR USE WITH SERIES 5000 SYRUP PUMPS



FLOJET

REGULAR 15F01-124

20+ \$17.95 10+ \$18.95 Ea. \$19.95

HIGH ALTITUDE 15F01-223

20+ \$17.95 10+ \$18.95 Ea. \$19.95

Additional price breaks available on most items. Login to your website account or contact your sales representative for pricing.

Liquid Fittings for Flojet Gas Pumps

Stainless steel outlets



Catalog No.	Description	50+	25+	10+	Each
12A01-120	Straight 1/4" B	1.05	1.10	1.20	1.25
04C03-306	Straight 3/8" B	1.05	1.10	1.20	1.25

Replacement O-rings

Catalog No.	Description	300+	100+	Each
12L01-115	O-ring for liquid fittings	0.10	0.12	0.15
12T07-132	O-ring for air fittings	0.09	0.10	0.15

Air Fittings for Gas Pumps

Brass inlets with shutoff valve

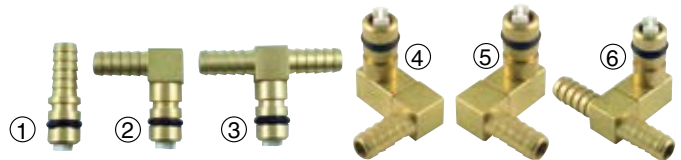

Ref.#	Catalog No.	Description	25+	10+	Each
1	12A01-122	Straight 1/4" B	1.93	2.05	2.15
2	15F01-104	Elbow 1/4" B	1.80	1.90	2.00
3	15F01-105	Tee 1/4" B	2.05	2.25	2.45
4	15F01-106	Left Offset 1/4" B	2.51	2.67	2.95
5	15F01-107	Right Offset 1/4" B	2.75	2.93	3.07
6	15F01-108	Tee Offset 1/4" B	2.55	2.75	2.95





Mounting Brackets for Gas Pumps

DESIGNED FOR USE WITH 5000 AND G SERIES PUMPS – ALSO WORKS WITH SHURFLO

USE INDIVIDUALLY OR SNAP TOGETHER INTO GROUPS – IDEAL FOR WALL OR RACK MOUNTING



15F01-131

48+ \$5.74

24+ \$6.05 12+ \$6.40

6+ \$6.79 Ea. \$7.23



WORKS WITH
FLOJET
5000 SERIES PUMPS



WORKS WITH
FLOJET
G SERIES PUMPS



WORKS WITH
SHURFLO
AIR DRIVEN PUMPS

HOUSES EIGHT 5000 SERIES PUMPS – IDEAL FOR WALL OR RACK MOUNTING



15F01-130

12+ \$25.95

8+ \$27.95 4+ \$28.95 Ea. \$29.95



WORKS WITH
FLOJET 5000 SERIES PUMPS

Quiet Operation Oil-Less Air Compressor

PERFECT FOR ALL BEVERAGE APPLICATIONS

Runs very quiet– 62 decibels – normal conversation is 60 decibels

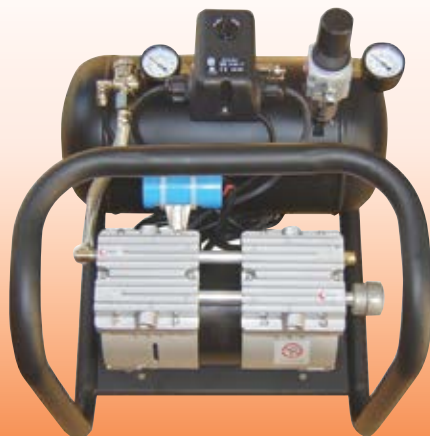

WILL NOT "WALK"
ACROSS FLOORS DURING
OPERATION.

DROP SHIPS ONLY

- 5/8 HP motor
- 110V/60Hz voltage
- 2.6 CFM output
- Maximum pressure 100 psi
- Operating pressure 70-100 psi
- **Noise level 62 decibels**
- 2 gallon tank size
- Includes filter/regulator with gauge
- Dimensions: 16.5" L x 13" W x 16" H
- Shipping weight 45 lbs.



**5 MICRON
FILTER/REGULATOR**
Regulator includes
gauge and has
1/4" FPT in/out ports



1/8" FPT PORTS
**AUTOMATIC
CONDENSATION
DRAIN VALVE**
Adjustable timer sets
from 1 to 120 minutes

Catalog No.	Description	Each
19B01-100	Compressor with Filter/Regulator (no drain valve)	523.95
19B01-101	Compressor with Filter/Regulator (with drain valve)	578.95
19B01-102	Auto Condensation Drain Valve (only)	118.95
19B01-103	5 mic Filter/Regulator with gauge (only)	43.95



BIB Connectors



①

QCD II CLIP-ON
Works with:
PCSS
DET
Q51
FTC



②

PCS CLIP-ON
Works with:
PCSS
DET
Q51
FTC



③

PCSS+ SCREW-ON
Works with:
PCSS
DET
Q51
ENCORE



④

ENCORE SCREW-ON
Works with:
PCSS
DET
ENCORE



⑤

COKE SCREW-ON
Works with:
COCA-COLA
PRODUCTS
ONLY



⑥

DR. PEPPER SCREW-ON
Works with:
CERTAIN TYPES
OF DR. PEPPER
SYRUP
PACKAGING

Ref.#	Catalog No.	Description	100+	50+	25+	10+	Each	
1	15F01-119	QCD-II	5.22	5.50	5.73	5.98	6.16	
2	15R01-101	PCS	CLOSEOUT					3.95
3	15R01-105	PCSS+	5.28	5.57	5.80	6.06	6.24	
4	15R01-104	Encore	4.95	5.25	5.50	5.95	6.50	

Ref.#	Catalog No.	Description	100+	50+	25+	10+	Each	
5	15T07-130	Coke Plastic Barb	2.70	2.80	2.95	3.10	3.25	
5	15T07-123	Coke S/S Barb	3.00	3.10	3.20	3.30	3.50	
6	15R01-103	Dr. Pepper Barb	6.95	7.25	7.50	7.75	8.25	
-	15F01-122	Universal Cap	CLOSEOUT					0.25

BIB Connection Adapters / Cleaning Adapters

USED WITH ABOVE CONNECTORS TO MAKE SWITCHING BETWEEN CONNECTION TYPES EASY
CAN ALSO BE USED TO CREATE LINE CLEANING ASSEMBLIES



WORKS WITH:
QCD II
PCS
SCREW-ON
PCS
CLIP-ON
ENCORE
SCREW-ON

15C07-147
100+ \$2.25 25+ \$2.50
10+ \$2.75 Ea. \$3.00



WORKS WITH:
COKE
SCREW-ON
CONNECTORS
ONLY

15C07-145
100+ \$2.55 25+ \$2.66
10+ \$2.83 Ea. \$2.97



WORKS WITH:
SCHOLLE L
SCREW-ON
SCHOLLE T
SCREW-ON
CONNECTORS
ONLY

15C07-146
25+ \$2.78
10+ \$2.95 Ea. \$3.09

Bevlex® Series 200

CRYSTAL CLEAR VINYL DUAL DUROMETER CONSTRUCTION

Very flexible • Excellent kink resistance • Taste protection properties

FOR B-I-B SUCTION LINES						PRICES PER 100'			PRICE PER FOOT
Catalog No.	I.D.	O.D.	Working Pressure at 70° F	Clamp Index	Roll Size	4 Rolls	2 Rolls	1 Roll	Under 100'
08A05-126	3/8"	5/8"	50	J	100'	26.13	28.00	29.70	.60



BevClean B-I-B Cartridge Beverage System Cleaner



NEUTRALIZES
PUNGENT
FLAVORS

20B05-150
3-GALLON

1 PALLET / 72 pc **\$12.95***

3+ \$15.95 Ea. \$16.95

NO-RINSE • FOOD-SAFE • TASTELESS • ODORLESS

- Cleans from the rack to the dispensing point
- Lab tested & proven safe for all system components
- No buckets, no mixing, no waiting, no rinsing
- Neutralizes pungent flavors in most cases
- Quickly perform flavor changes without replacing tubing
- Use regularly to reduce quality issues

***PALLET SHIPPED FROM MANUFACTURER IN OH**

Fruit Fly Bar Pro — Odorless Vapor Strips

ELIMINATES PESKY FRUIT FLIES AND MANY OTHER INSECTS

FOR BARS AND DINING AREAS – TREATMENT DURING CLOSING HOURS IS RECOMMENDED

20B05-100

12+ CASES / 10 STRIPS **\$72.95/CS**
6+ CASES / 10 STRIPS **\$74.95/CS**
3+ CASES / 10 STRIPS **\$76.95/CS**
1+ CASE / 10 STRIPS **\$78.95/CS**

- Each strip effectively covers 200 cubic feet (8' x 5' x 5') area
- Effectively KILLS, prevents and protects for up to 4 months
- Targets hard-to-reach REPRODUCING AREAS with deep penetrating vapor
- Insects are immediately affected, infected will die within 24 hours
- No more costly extermination or expensive name brand sprays
- Works and protects for pennies a day
- Also kills gnats, cockroaches, spiders, and silverfish

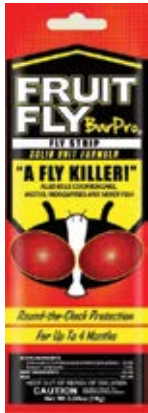

Refractometers with Auto-Temp Compensation

MONITORS SUGAR LEVELS IN HOT/COLD DRINKS WITH AN EASY-TO-READ 0 TO 32 BRUX SCALE



Economy Model

Includes: Hardshell case and sample dropper

20C04-110

20+ **\$34.95** 10+ \$36.95
5+ \$38.95 Each \$40.95

Industrial Model

Includes: Hardshell case and sample dropper

20C04-111

20+ **\$39.95** 10+ \$41.95
5+ \$44.95 Each \$47.95

Lighted Model

Includes: Hardshell case and sample dropper

20C04-112

20+ **\$39.95** 10+ \$41.95
5+ \$44.95 Each \$47.95



Carbonation Testers



Made for Pepsi®

- Gauge protection boot to minimize damage
- Easy to use and read scale
- Easy to follow instructions
- Made of sturdy ABS plastic

20E09-101 Ea. **\$108.95**

FOR MEASURING CARBONATION LEVELS IN SOFT DRINKS



General Beverages

- Gauge protection boot to minimize damage
- Easy to use and read scale
- Easy to follow instructions
- Made of sturdy ABS plastic

20E09-102 Ea. **\$108.95**

Thermometers



COMARK

A Fluke Company



DIGITAL

20K04-109
24+ **\$9.86**

- Easy-to-read LCD display
- On/off button, auto power off
- -40° to 300°F temp range
- 1.0% over full scale accuracy

12+ \$10.36 Ea. \$11.45



COMARK

A Fluke Company



DIGITAL

20K04-107
10+ **\$20.95**

- Easy-to-read LCD display
- On/off button, auto power off
- -58° to 300°F temp range
- +/- 2% accuracy

5+ \$21.95 Ea. \$22.95

Additional price breaks available on most items. Login to your website account or contact your sales representative for pricing.



COMARK

A Fluke Company

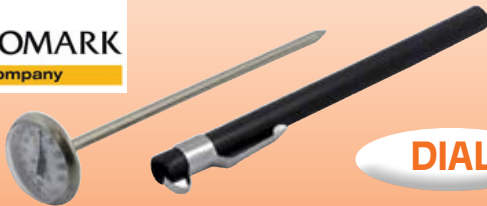

DIAL

Hot Drinks 0 to 220°F

20K04-105
24+ **\$2.52**

- 1" head diameter with zero reset adjustment.
- 5" stainless steel probe
- Polycarbonate crystal.

12+ \$2.78 Ea. \$2.95

Cold Drinks -40 to 160°F

20K04-103
12+ **\$3.31**

- 1" head diameter with zero reset adjustment.
- 5" stainless steel probe
- Polycarbonate crystal.

6+ \$3.61 Ea. \$3.98

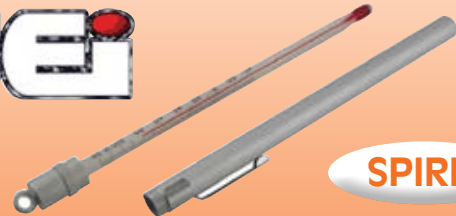

SPIRIT

Cold Drinks -40 to 120°F

20K04-102
12+ **\$5.58**

- Magnifying lens for easy-to-read temperature
- Red against white column
- Aluminum pocket sheath

6+ \$6.08 Ea. \$6.45



COMARK

A Fluke Company

Professional Grade

- -40° to 1,000°F range
- ± 2°F accuracy
- 4' coiled probe cord
- Water resistant and easy to clean keypad

DIGITAL

20K04-210
Ea. **\$168.95**



Infrared Units



INF165C

- -76° to 1022°F range
- 12:1 Distance to spot ratio
- 2 Emissivity levels (.70, .95)
- Max value capture
- Auto off



20K04-155
Ea. **\$50.95**

DIGITAL

INF195C

- -76° to 1022°F range
- 12:1 Distance to spot ratio
- 3 emissivity levels (.30, .70, .95)
- MIN/MAX differential, average
- Hi/Low alarm (user adjustable)

20K04-185
Ea. **\$98.95**



Wunder-Bar Accessory Items

Wunder-Bar Dispenser Accessories



MARK IV PARTS KIT
12Q08-211
\$147.95



INCLUDES LOCK AND TWO KEYS

S/S LOCKING COVER
12Q08-128
\$58.95



NEW SANITARY DESIGN

DRIP CUP ASSEMBLY
12Q08-117
\$11.00



INSTALLS TINY O-RINGS

MARK IV O-RING TOOL
12Q08-170
\$5.50



FOR HANDS-FREE OPERATION

WAITRESS STATION
12Q08-297
\$89.95

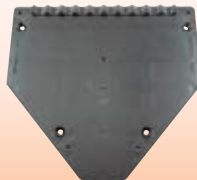

12Q08-107
10 BUTTON

INCLUDES MOUNTING HARDWARE



12Q08-109
12/14 BUTTON

KWIK-MOUNT PLATES
12Q08-107 **\$7.06**
12Q08-109 **\$7.95**

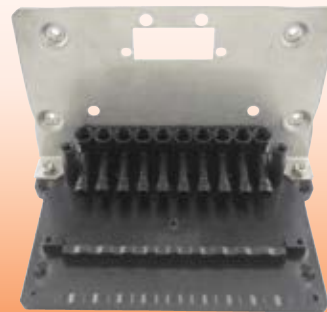

90° ADAPTER KIT

Use with existing manifold to create a right angle for easy installation into tight areas and have easy access to brixing adjustments and shutoff screws.

12Q08-361 1 to 6 Button Manifold **\$35.95**
12Q08-362 7 to 10 Button Manifold **\$40.95**
12Q08-363 12 to 14 Button Manifold **\$48.95**

Additional price breaks available on most items. Login to your website account or contact your sales representative for pricing.



I.D. Caps – FOR USE WITH THE FOLLOWING BUTTONS

12Q08-262 (Post-Mix Button) & 12Q08-296 (Pre-Mix/Wine Button)

50+ **37¢** 25+ **38¢** Ea. **41¢**

Catalog No.	Description
12Q08-501	7UP
12Q08-530	A
12Q08-531	B
12Q08-532	B
12Q08-502	B MARY
12Q08-580	BANZI
12Q08-581	BANZI
12Q08-577	BL
12Q08-533	C
12Q08-534	C
12Q08-503	COKE
12Q08-504	CRAN
12Q08-557	D
12Q08-505	DIET

Catalog No.	Description
12Q08-506	DIET
12Q08-507	DIET
12Q08-508	DR P
12Q08-574	ENERGY
12Q08-582	FUEL
12Q08-535	G
12Q08-536	G
12Q08-509	G ALE
12Q08-510	GRAPE
12Q08-511	GRPFT
12Q08-537	I
12Q08-538	L
12Q08-539	L
12Q08-512	L ADE

Catalog No.	Description
12Q08-513	L ADE
12Q08-514	LEMON
12Q08-583	LION
12Q08-541	M
12Q08-515	MIST
12Q08-516	MT DEW
12Q08-542	O
12Q08-543	O
12Q08-517	ORG
12Q08-544	P
12Q08-545	P
12Q08-518	PEPSI
12Q08-519	PIBB
12Q08-520	PINE

Catalog No.	Description
12Q08-521	PUNCH
12Q08-546	Q
12Q08-547	R
12Q08-522	R BEER
12Q08-548	RC
12Q08-549	S
12Q08-523	SLICE
12Q08-524	SOUR
12Q08-525	SPRITE
12Q08-550	SQ
12Q08-526	SQUIRT
12Q08-551	SS
12Q08-527	STRAW
12Q08-552	T

Catalog No.	Description
12Q08-553	T
12Q08-528	TEA
12Q08-584	THROTL
12Q08-529	TONIC
12Q08-578	TR
12Q08-579	TSF
12Q08-554	W
12Q08-555	W
12Q08-556	
12Q08-575	
12Q08-576	
12Q08-585	
12Q08-586	
12Q08-587	



Wunder-Bar Dispensing Systems

SETTING THE INDUSTRY GOLD STANDARD FOR OVER 40 YEARS

MARK 4

NEW AND IMPROVED DISPENSERS

FEATURES

- Stem seal o-ring easily replaced from top of handle (even under pressure)
- New shut-off screw with soft tip for a positive seal
- Lock-in-place hat plugs allow for individual flavor repair
- Nozzle features a twist lock connection
- Flex hose bushing is welded stainless steel (no longer plastic)



MODELS AVAILABLE UPON REQUEST

QUICK DISCONNECT POSTMIX DISPENSERS

Catalog No.	Accent Color	Total # of Btns	Carb Btns	Non-Carb Btns	Soda Btn	Water Btn	6+	3+	Each
12Q08-103	Black	7	4	1	1	1	220.95	225.95	231.95
12Q08-101	Black	7	5	-	1	1	220.95	225.95	231.95
*12Q08-305	Red	7	5	-	1	1	303.95	311.95	319.95
12Q08-401	Blue	7	5	-	1	1	220.95	225.95	231.95
12Q08-102	Black	8	5	1	1	1	221.95	227.95	232.95
*12Q08-310	Red	8	5	1	1	1	316.95	324.95	333.95
12Q08-402	Blue	8	5	1	1	1	221.95	227.95	232.95
12Q08-135	Black	8	6	-	1	1	221.95	227.95	232.95
*12Q08-315	Red	8	6	-	1	1	316.95	324.95	333.95
12Q08-435	Blue	8	6	-	1	1	221.95	227.95	232.95
12Q08-119	Black	10	6	2	1	1	243.95	249.95	255.95
*12Q08-330	Red	10	6	2	1	1	357.95	366.95	375.95
12Q08-419	Blue	10	6	2	1	1	243.95	249.95	255.95
12Q08-244	Black	12	6	4	1	1	287.95	294.95	302.95
*12Q08-340	Red	12	6	4	1	1	416.95	426.95	437.95
12Q08-444	Blue	12	6	4	1	1	287.95	294.95	302.95
12Q08-245	Black	14	6	6	1	1	320.95	328.95	336.95
*12Q08-360	Red	14	6	6	1	1	454.95	465.95	477.95
12Q08-445	Blue	14	6	6	1	1	320.95	328.95	336.95

* All Red guns are "Flow Regulator" type, as specified by Coke®

FAST FLOW POSTMIX DISPENSERS

Catalog No.	Accent Color	Total # of Btns	Carb Btns	Non-Carb Btns	Soda Btn	Water Btn	6+	3+	Each
12Q08-223	Black	1	-	1	-	-	163.95	168.95	172.95
12Q08-257	Black	2	-	2	-	-	182.95	187.95	191.95

QUICK DISCONNECT JUICE DISPENSERS

Catalog No.	Accent Color	Total # of Btns	Carb Btns	Non-Carb Btns	Soda Btn	Water Btn	6+	3+	Each
12Q08-246	Black	7	-	6	-	1	221.95	227.95	232.95
12Q08-248	Black	9	-	8	-	1	245.95	251.95	257.95

ENERGY DRINK DISPENSERS

Catalog No.	Accent Color	Total # of Btns	Carb Btns	Non-Carb Btns	Soda Btn	Water Btn	6+	3+	Each
12Q08-420	Black	2	1	-	1	-	161.95	165.95	170.95
12Q08-421	Black	3	2	-	1	-	175.95	179.95	184.95
12Q08-422	Black	4	3	-	1	-	185.95	190.95	195.95
12Q08-424	Black	5	4	-	1	-	198.95	203.95	209.95



Wunder-Bar Dispensers



Wunder-Bar Replacement Parts

Wunder-Bar Dispenser Replacement Parts

All Series Post-Mix Handles

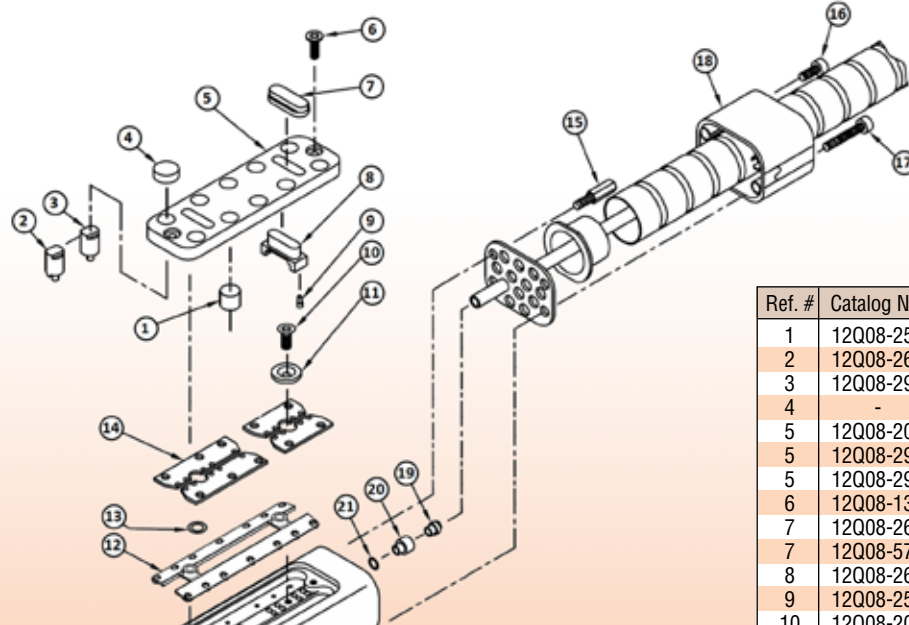

**NOT FINDING THE PARTS YOU WANT?
OTHER PARTS ARE AVAILABLE.
CALL YOUR SALES REPRESENTATIVE FOR PRICING.**

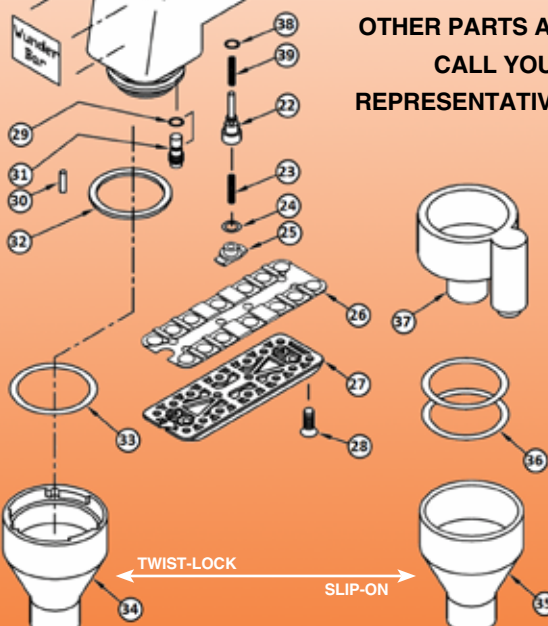

Butterfly Plate Selection

Ref. #	Catalog No.	Description	Each
1	12Q08-255	Button Plug (Black)	0.17
2	12Q08-262	Button (For Round I.D. Caps)	0.27
3	12Q08-296	Button (For Wine/Premix)	0.69
4	-	Round I.D. Caps (See pg. 42)	
5	12Q08-205	Button Plate-10 Btn (Black)	3.07
5	12Q08-294	Button Plate-12 Btn (Black)	4.59
5	12Q08-295	Button Plate-14 Btn (Black)	4.59
6	12Q08-138	Screw, Button Plate	0.17
7	12Q08-261	Oblong I.D. Cap (Soda)	0.37
7	12Q08-573	Oblong I.D. Cap (Water)	0.37
8	12Q08-263	Button (For Oblong I.D. Caps)	0.32
9	12Q08-254	Foot Extension (for Oblong Btn)	0.44
10	12Q08-208	Screw, Butterfly Retainer (for 2.5 & III)	0.18
10	12Q08-272	Screw, Butterfly Retainer (M4)	0.17
11	12Q08-209	Retainer, Butterfly Plate (for 2.5 & III)	0.41
11	12Q08-271	Retainer, Butterfly Plate (M4)	0.52
12	12Q08-267	Plate, Retainer 7, 8, 10 Btn (M4)	0.71
12	12Q08-268	Plate, Retainer 12 Btn (M4)	2.58
12	12Q08-269	Plate, Retainer 14 Btn (M4)	2.58
12	12Q08-270	Plate, Retainer All Energy Drink (M4)	0.71
13	12Q08-266	O-ring, Secondary Water Brix Screw	0.50
14	SEE BUTTERFLY PLATE SELECTION AT BOTTOM OF PAGE		
15	12Q08-212	Tube Retainer Post	0.78
16	12Q08-214	Screw, Handle Heel (1/2 L)	0.17
17	12Q08-215	Screw, Handle Heel (1 L)	0.17
18	12Q08-291	Split Handle Heel-10 Btn (Black)	2.13
18	12Q08-292	Split Handle Heel-12 Btn (Black)	4.59
18	12Q08-293	Split Handle Heel-14 Btn (Black)	4.59
19	12Q08-145	Tube Ferrule	0.20
20	12Q08-201	Cap, Tube Ferrule	0.19
21	12Q08-142	O-ring, Tube Seal	0.15
22	12Q08-174	Valve Stem, Santoprene	2.06
23	12Q08-171	Valve Spring	0.34
24	12Q08-133	O-ring, Hat (Not for Mark IV)	0.24
24	12Q08-142	O-ring, Hat (For Mark IV)	0.15
25	12Q08-172	Hat, Spring (Not for Mark IV)	0.17
25	12Q08-161	Locking Access Plug (For Mark IV)	0.14
26	12Q08-165	Locking Hat Plate-10 Btn	5.15
26	12Q08-167	Locking Hat Plate-12 Btn	5.15
26	12Q08-168	Locking Hat Plate-14 Btn	5.15
27	12Q08-219	Bottom Plate-10 Btn (Black)	1.08
27	12Q08-571	Bottom Plate-12 Btn (Black)	3.07
27	12Q08-572	Bottom Plate-14 Btn (Black)	3.07
28	12Q08-220	Screw, Bottom Plate	0.17
29	12Q08-266	O-ring, Secondary Water Brix Screw	0.50
30	12Q08-162	Diffuser Plug, Syrup Outlet Hole	0.18
31	12Q08-163	Secondary Water Brix Screw	1.20
32	12Q08-164	Diffuser Ring, Juice (For 2.5 & III)	3.61
33	12Q08-253	Diffuser O-ring, (For 2.5, III, Mark IV)	0.37
34	12Q08-252	Nozzle, Twist-Lock (Black)	1.81
35	12Q08-265	Nozzle, Slip-On (Black)	1.62
36	12Q08-113	Diffuser O-ring (For Series II Only)	0.22
37	12Q08-112	Syrup Separator (For All Series)	10.95
38	12Q08-131	O-ring	0.50
39	12Q08-218	Spring, Stem	0.22

Ref.#	Catalog No.	Description	Each	Ref.#	Catalog No.	Description	Each
14	12Q08-191	1-Hole Left	3.16	14	12Q08-351	4-Hole #3	3.98
14	12Q08-192	1-Hole Right	3.16	14	12Q08-352	4-Hole #4	3.98
14	12Q08-193	2-Hole	3.26	14	*12Q08-354	5-Hole Left	20.69
14	12Q08-194	3-Hole Left	3.16	14	*12Q08-355	5-Hole Right	20.69
14	12Q08-195	3-Hole Right	3.16	* REQUIRES 1 PC 12Q08-254 TO USE			
14	12Q08-196	4-Hole Left	3.16	14	12Q08-356	5-Hole Left 14 Btn	27.81
14	12Q08-197	4-Hole Right	3.16	14	12Q08-357	5-Hole Right 14 Btn	28.50

Wunder-Bar Replacement Parts

All Series of Post-Mix Manifold Parts

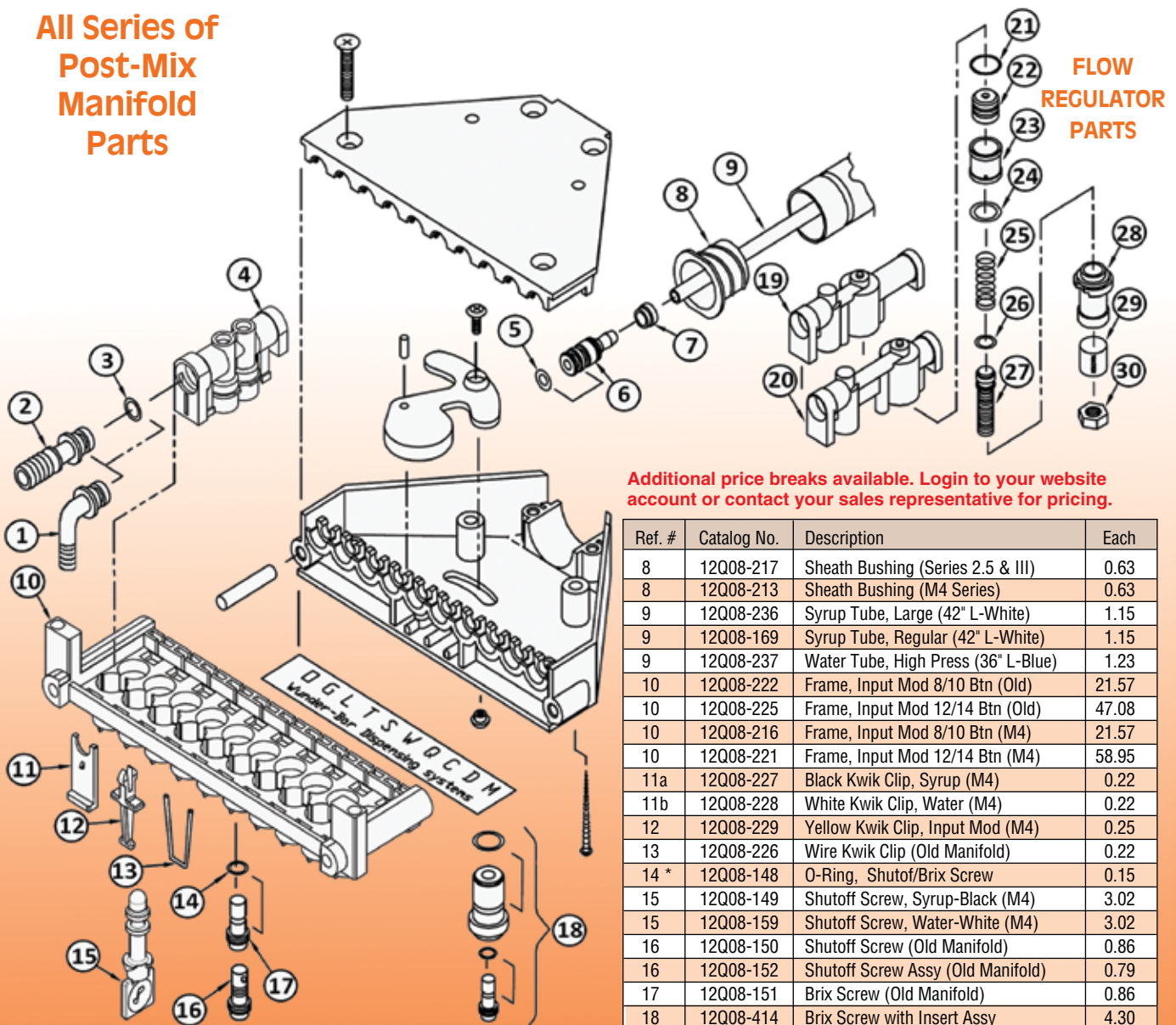

Additional price breaks available. Login to your website account or contact your sales representative for pricing.

Ref. #	Catalog No.	Description	Each
1	12Q08-104	90° Input Fitting, 1/4" Barb S/S	2.25
2	12Q08-105	Input Fitting, 1/4" Barb S/S	1.25
2	12Q08-241	Input Fitting, 3/8" Barb S/S (Short)	1.31
2	12Q08-242	Input Fitting, 3/8" Barb S/S (Long)	2.81
3	12Q08-106	O-Ring, Input Fitting	0.15
4	12Q08-200	Input Module (Old Manifold)	4.03
4**	12Q08-203	Input Module (M4 Manifold)	4.54
5	12Q08-231	O-Ring, Interconnect Fitting	0.15
6	12Q08-232	Interconnect Fitting (Syrup)	0.63
6	12Q08-234	Interconnect Fitting (Water)	0.63
7	12Q08-233	Lock Ring (for Syrup Line)	0.25
7	12Q08-235	Lock Ring (for Water Line)	0.25

Ref. #	Catalog No.	Description	Each
8	12Q08-217	Sheath Bushing (Series 2.5 & III)	0.63
8	12Q08-213	Sheath Bushing (M4 Series)	0.63
9	12Q08-236	Syrup Tube, Large (42" L-White)	1.15
9	12Q08-169	Syrup Tube, Regular (42" L-White)	1.15
9	12Q08-237	Water Tube, High Press (36" L-Blue)	1.23
10	12Q08-222	Frame, Input Mod 8/10 Btn (Old)	21.57
10	12Q08-225	Frame, Input Mod 12/14 Btn (Old)	47.08
10	12Q08-216	Frame, Input Mod 8/10 Btn (M4)	21.57
10	12Q08-221	Frame, Input Mod 12/14 Btn (M4)	58.95
11a	12Q08-227	Black Kwik Clip, Syrup (M4)	0.22
11b	12Q08-228	White Kwik Clip, Water (M4)	0.22
12	12Q08-229	Yellow Kwik Clip, Input Mod (M4)	0.25
13	12Q08-226	Wire Kwik Clip (Old Manifold)	0.22
14 *	12Q08-148	O-Ring, Shutoff/Brix Screw	0.15
15	12Q08-149	Shutoff Screw, Syrup-Black (M4)	3.02
15	12Q08-159	Shutoff Screw, Water-White (M4)	3.02
16	12Q08-150	Shutoff Screw (Old Manifold)	0.86
16	12Q08-152	Shutoff Screw Assy (Old Manifold)	0.79
17	12Q08-151	Brix Screw (Old Manifold)	0.86
18	12Q08-414	Brix Screw with Insert Assy	4.30
19	12Q08-569	Input Module, Flow Reg (#1)	12.89
20	12Q08-570	Input Module, Flow Reg (#2)	12.89
21	12Q08-568	O-Ring, Cylinder (syrup/Water)	0.71
22	12Q08-564	Piston, Ceramic (Syrup)	8.59
22	12Q08-565	Piston, Ceramic (Water)	8.59
23	12Q08-566	Cylinder, Ceramic (Syrup)	12.89
23	12Q08-567	Cylinder, Ceramic (Water)	12.89
24	12Q08-560	O-ring, Tube Retainer	0.15
25	12Q08-563	Spring, Tension	0.41
26	12Q08-562	O-ring, Adj Screw	0.29
27	12Q08-561	Adj Screw, Flow Reg (Syrup/Water)	0.34
28	12Q08-559	Tube Retainer (Syrup/Water)	2.16
29	12Q08-158	Label, Retainer Tube (Specify Type)	0.86
30	12Q08-558	Nut, Lock	0.27

**Includes: 1pc #4, 2pc #11a, 2pc #11b, 2pc #12

Wunder-Bar Dispenser Replacement Parts



UF-1 Adjustable Flow Rate Valves

ADJUSTABLE FROM 1.5 OZ. – 3.0 OZ. PER SECOND



Sanitary
Lever



Push
Button



Optifill™
Automatic
Shutoff
Sensor

MOUNTING BLOCK INCLUDED WITH VALVE

Catalog No.	Description	25+	12+	6+	Each	
12C07-500	Lever (Sanitary)	124.95	131.95	138.95	146.95	
12C07-501	Push Button	126.95	132.95	140.95	148.95	
Catalog No.	Description			6+	3+	Each
12C07-503	Optifill™ Auto Shutoff Valve			239.95	248.95	257.95

Replacement Parts for Adjustable Flow Rate Valves

Additional price breaks available on most items. Login to your website account or contact your sales representative for pricing.

Ref.#	Catalog No.	Description	Each
1	12C07-559	O-Ring (.028 I.D.)	0.10
2	12C07-510	Body, Flow Control 1.5 – 3.0/sec (Black)	4.95
2	12C07-101	Body, Flow Control 2.0 – 4.0/sec (Blue)	9.50
3	12C07-578	O-Ring (.239 I.D.)	1.00
4	12C07-571	O-Ring (.676 I.D.)	0.15
5	12C07-577	Screw, Retainer Plate (#8-16 x 3/4L)	0.35
6	12C07-569	Piston, Water (1.5 – 3.0 oz.)	16.95
6	12C07-103	Piston, Water (2.0 – 4.0 oz.)	7.50
7	12C07-536	Cylinder, Water/Syrup (Universal)	18.95
7	12C07-104	Cylinder, Juice	42.95
8	12C07-542	Spring, Flow Control (1.5 – 3.0 oz.)	.85
8	12C07-106	Spring, Flow Control (2.0 – 4.0 oz.)	4.25
9	12C07-513	Screw, Nylon Adjustment	0.65
9a	12C07-512	Top, Flow Control	1.50
10	12C07-531	Retainer Plate, Flow Control	7.95
11	12C07-568	Piston, Syrup (1.5 – 3.0 o.)	18.95
11	12C07-539	Piston, Syrup (2.0 – 4.0 oz.)	6.50
12	12C07-573	Cap Housing, Flow Washer	1.75
13	12C07-286	Flow Washer (.60 GPM) Low Flow	2.95
13	12C07-574	Flow Washer (1.0 GPM) High Flow	6.50
14	12C07-551	Housing, Flow Washer	4.75
15	12C07-502	Valve Body (Switch not included)	5.95
16	12C07-549	Banjo Valve, Water (Black)	2.55
17	12C07-549	Banjo Valve, Syrup (Black)	2.55
18	12C07-564	Screw, TT #6-19 PAPH 24	0.50
19	12C07-521	Solenoid AC	38.95
20	12C07-504	Valve Head (Black)	4.95

Ref.#	Catalog No.	Description	Each
21	12C07-514	Actuator Arm	0.75
22	12C07-109	U-Pin Retainer, Flow Control	0.75
23	12C07-561	O-Ring (1.174 I.D.)	0.17
24	12C07-533	Spring, Return Valve	0.50
25	12C07-110	Cover, Solenoid	0.78
26	12C07-582	Mounting Block Assembly (Complete)	20.95
27	12C07-580	O-Ring (.426 I.D.)	0.15
28	12C07-506	Bottom Plate	2.50
29a	12C07-105	Lever, Sanitary (pictured right)	11.50
29b	12C07-111	Lever, Standard (pictured middle)	12.95
29c	12C07-112	Lever, Optifill™ (pictured left)	10.95
30	12C07-113	Nozzle Assembly (Complete)	5.95
30	12C07-107	Nozzle Assembly for Juice (Complete)	14.95
31	12C07-570	O-ring (.239 I.D.)	0.15
32	12C07-516	Diffuser	1.55
33	12C07-581	O-Ring, Diffuser (.926 I.D.)	0.17
34	12C07-520	Inner Baffle	2.95
34	12C07-102	Inner Baffle for Juice	9.95
35	12C07-547	Nozzle only (Black)	1.75
36	12C07-558	Front Cover (for Lever Valves)	2.05
36	12C07-553	Front Cover (for Non-Lever Valves)	1.95
37	12C07-552	Back Cover	4.50
38	12C07-527	Switch/Harness (for Lever Valves)	6.25
38a	12C07-526	Switch/Harness (for Push Button Valves)	11.50
40	12C07-565	Module Assembly (Push Button)	42.95
40	12C07-576	DISCONTINUED	–
40	12C07-579	Module Assembly (Optifill™)	105.95



Replacement Parts for Adjustable Flow Rate Valves

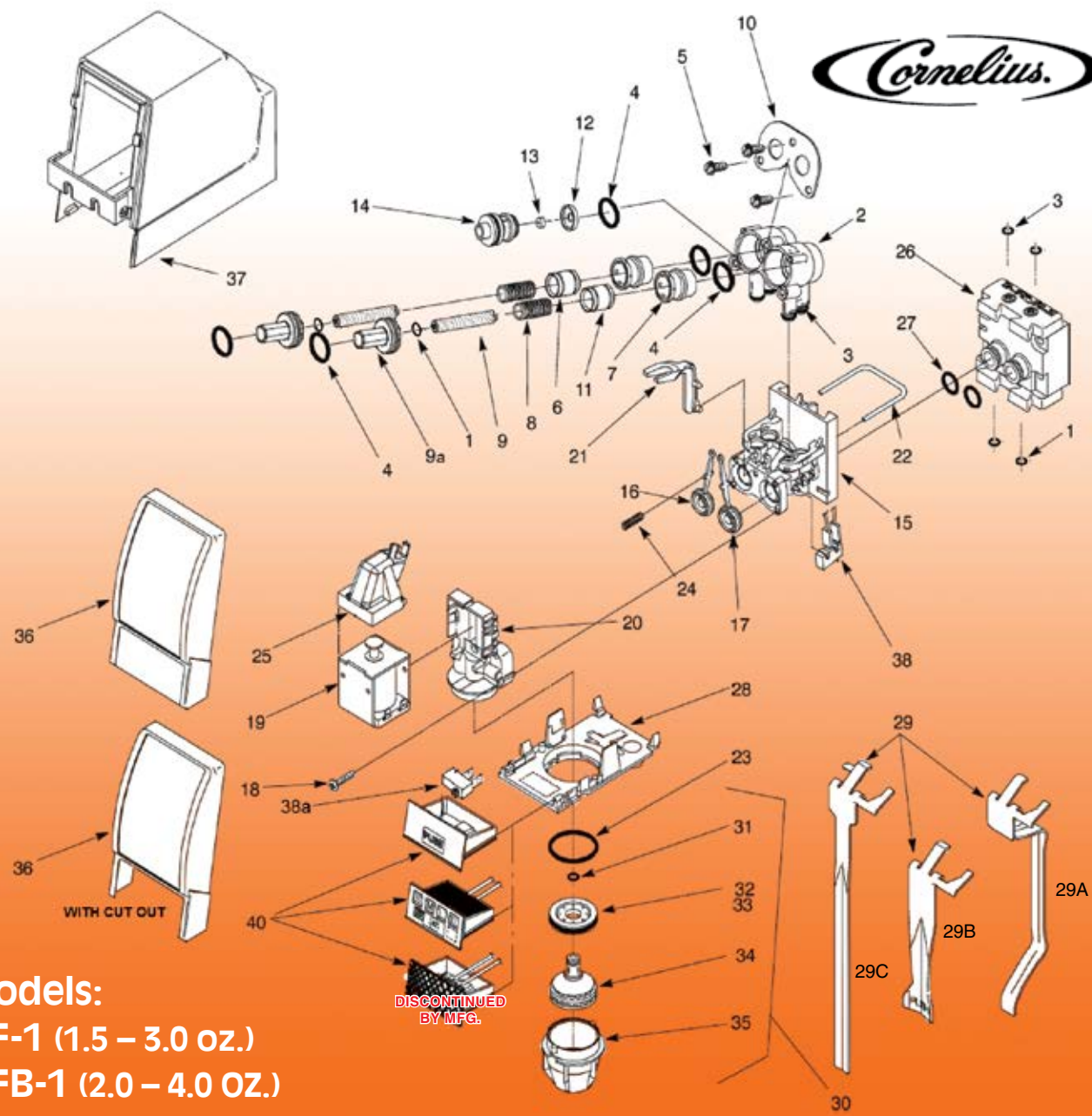

Soda Valves - Cornelius

Models:
UF-1 (1.5 – 3.0 oz.)
UFB-1 (2.0 – 4.0 oz.)

HIGH FLOW to LOW FLOW CONVERSION KIT
 Adjustable Flow Rate will be 1.5–3.0 oz. per second
12C07-556 3+ \$49.95 Ea. \$52.95

LOW FLOW to HIGH FLOW CONVERSION KIT
 Adjustable Flow Rate will be 2.0–4.0 oz. per second
12C07-557 3+ \$59.95 Ea. \$63.95

Additional price breaks available on most items. Login to your website account or contact your sales representative for pricing.



Water/Soda Side Lever Kit
12C07-583
\$8.50



90° Inlet Fitting
04T07-102
\$1.90

Replacement O-ring 12T07-132 **0.15**



SF1/UF1 By-Pass Assembly
12C07-249
\$13.95

LANCER LEV 3.0 oz. Postmix Valves



**Short
Lever**



**Push
Button**



**Sanitary
Lever**

**1.5 to 3.0 oz.
per second flow rate**

The LEV® is built with the highest quality materials and proven technology to provide consistent drink quality and product reliability

- Consistent "Best in Class" performance
- Lowest "Life Cost" of operation available
- Widest range of ratio control (2:1 - 10:1)
- Simple design gives high reliability

**MOUNTING
BLOCK
INCLUDED**

Catalog No.	Description	25+	12+	6+	Each
12L01-100	Short Lever	74.95	77.95	80.95	85.95
12L01-102	Push Button	82.95	85.95	90.95	95.95
12L01-108	Long Lever	75.95	77.95	82.95	86.95

Replacement Parts for 3.0 oz. and 4.5 oz.

Additional price breaks available on most items. Login to your website account or contact your sales representative for pricing.

Ref. #	Catalog No.	Description	Each
1	12L01-111	Front cover, Lever (Standard)	2.08
1b	12L01-112	Front Cover, Push Button	13.95
2	12L01-113	Cover, Top	6.25
3	12L01-105	Stem, Valve	1.52
4	12L01-114	Washer, Stem	0.43
5	12L01-115	O-ring	0.15
6	12L01-109	Screw	0.22
7	12L01-120	Retainer, Stem	0.80
8	12L01-116	Mounting Block Assy (3-8, 22)	9.39
9	12L01-140	Retainer, Valve	0.80
10	12L01-139	Spring, Pin	0.22
11	12L01-141	Screw	0.22
12	12L01-137	Upper Body Assy	14.95
13	12L01-142	Screw	0.31
14	12L01-117	Sleeve, Syrup/Soda 3.0 oz	9.95
14	12L01-161	Sleeve, Syrup/Soda 4.5 oz	10.95
15	12L01-118	Piston, Syrup 3.0 oz	5.66
15	12L01-162	Piston, Syrup 4.5 oz	6.55
16	12L01-143	O-ring	0.22
17	12L01-144	Wiring Harness with Microswitch	7.45
17a	12L01-177	Wiring Harness (Syrup Out)	14.95
18	12L01-121	Piston, Soda 3.0 oz	5.77
18	12L01-163	Piston, Soda 4.5 oz	6.55
19	12L01-122	Spring, Syrup	0.90
20	12L01-123	Spring, Soda	0.94
21	12L01-145	Bonnet, Flow Control	3.00
22	12L01-146	O-ring	0.15
23	12L01-147	Plug, Flow Control Adjustment	1.95
24	12L01-149	Retainer, Flow Control	0.91
25	12L01-150	Screw	0.38
26	12L01-125	Paddle Arm Assy (Banjo Valve)	4.42
27	12L01-126	Lower Body Assy 3.0 oz	4.57
27	12L01-164	Lower Body Assy 4.5 oz	10.95
28	12L01-127	O-ring, Nozzle 3.0 oz (Through 09/98)	0.18
29	12L01-151	Bottom Plate 3.0 oz	4.86
29	12L01-165	Bottom Plate 4.5 oz	5.87

Ref. #	Catalog No.	Description	Each
30	12L01-152	Screw	0.34
31	12L01-128	O-ring, Diffuser (Through 09/98)	0.23
32	12L01-153	Plug, Bottom Plate	0.73
33	12L01-138	Pin, Soda Lever 3.0 oz	0.59
34	12L01-103	Nozzle 3.0 oz	3.50
35	12L01-134	Spring, Lever	0.49
36	12L01-136	Lever, Self Serve (Long)	2.08
36b	12L01-135	Lever (Short)	4.25
37	12L01-130	Yoke	1.06
38	12L01-106	Coil Assy	9.75
39	12L01-131	Spring, Solenoid	0.43
40	12L01-132	Armature	1.95
41	12L01-167	Plug, Micro Switch Retainer	0.22
42	12L01-107	Micro Switch	1.10
43	12L01-155	Screw	0.34
44	12L01-179	Lever, Front (Soda/Water)	7.95
45	12L01-169	Pin, Front Soda/Water Lever	0.74
46	12L01-170	Spring, Front Lever	0.69
47	12L01-171	Screw	0.25
48	12L01-172	Holder, Syrup Out Wire	0.95
49	12L01-129	Lever, Soda 3.0 oz	2.18
50	12L01-104	Diffuser, 3.0 oz	3.25
51	12L01-128	O-ring, Diffuser 4.5 oz	0.23
52	12L01-174	Seal, Nozzle 4.5 oz	0.65
54	12L01-176	Flow Control Syrup Kit 3.0 oz	20.95
54a	12L01-160	Flow Control Syrup Kit 4.5 oz	18.95
55	12L01-168	Flow Control Soda Kit 3.0 oz	21.95
56	12L01-180	Flow Control Soda Kit 4.5 oz	18.95
57	12L01-157	Nozzle Assy Complete 4.5 oz	13.95
58	12L01-182	Front Lever Kit (Soda/Water)	15.95
59	12L01-148	Flow Control Assy (16, 21-23)	2.30
60	04T07-102	90° Inlet 1/4 Barb (S/S)	1.90
61	12E04-395	Straight S/S Inlet 1/4 Barb	1.55
62	12T07-132	O-ring, Inlet	0.15
63	12L01-101	Syrup Separator 3.0 oz (2-Prong)	9.95
64	12L01-110	Syrup Separator 4.5 oz (3-Prong)	18.50
65	12L01-156	Syrup Separator Multi-Flvr (4-Prong)	8.95



LANCER Replacement Parts for 3.0 oz. and 4.5 oz.

Soda Valves - Lancer

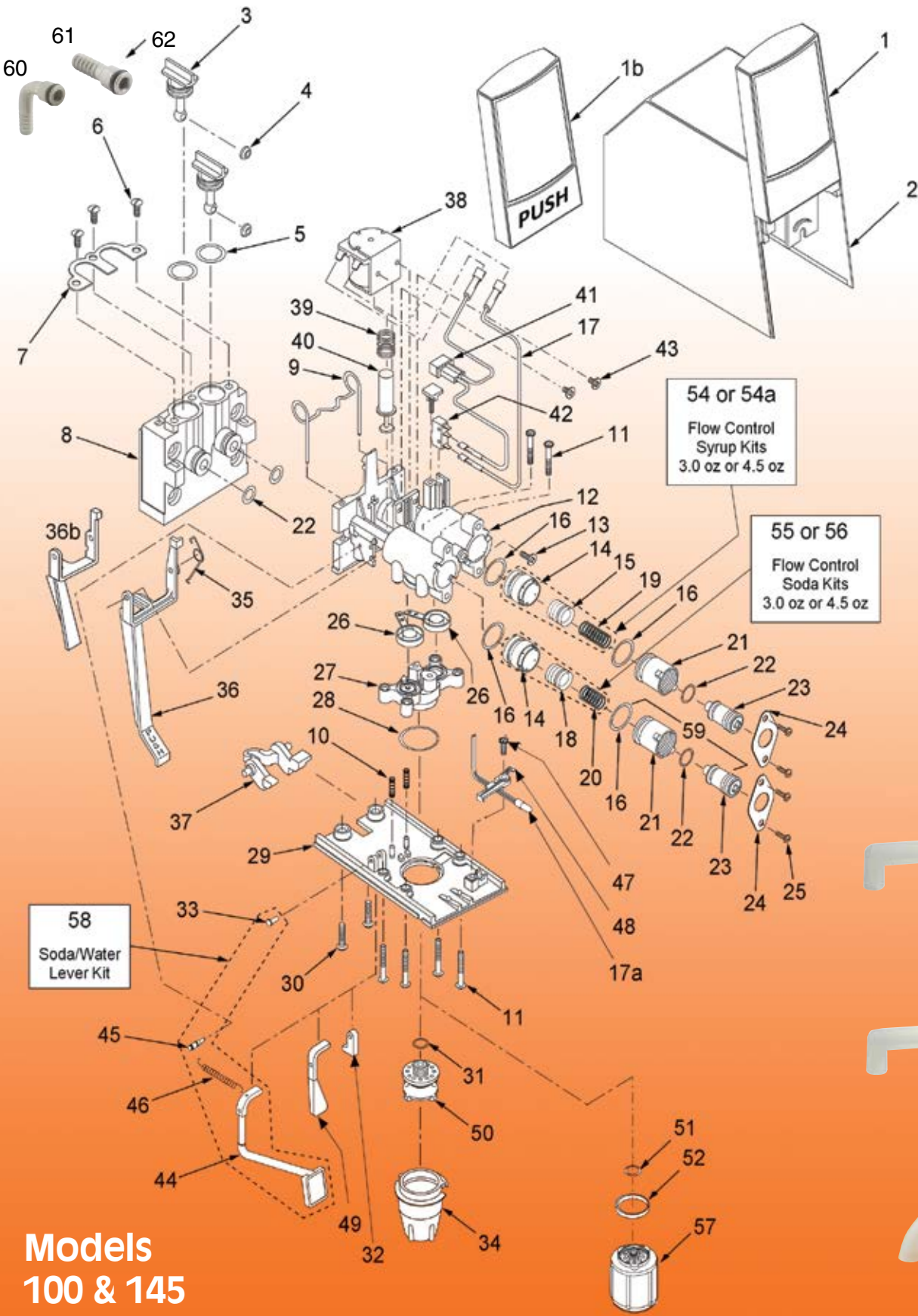

**Models
100 & 145**



Manitowoc Flomatic 424 & 464 Postmix Valves

CONSISTENT DRINK QUALITY AND PERFORMANCE OVER A BROAD FLOW RANGE

424 VALVE: 1.5 to 3.0 oz. per second flow rate
464 VALVE: 2.0 to 4.0 oz. per second flow rate

- Superior cup carbonation levels on both cold carb and ambient systems
- Maintains consistent ratio control
- Soft pour diffusion system reduces foam
- Quiet and powerful 24 volt AC solenoid provides consistent power and reliable performance
- Durable mounting block with quad seals to prevent leaks

Soda Valves - Flomatic

Sanitary Lever Models



MOUNTING BLOCK SOLD SEPARATELY

Catalog No.	Type	25+	12+	6+	Each
12D06-170	424 (Soda)	66.95	70.95	74.95	78.95
12D06-209	464 (Soda)	75.95	80.95	84.95	89.95

Push Button Models



424 Model JUICE MODEL AVAILABLE **464 Model**

MOUNTING BLOCK SOLD SEPARATELY

Catalog No.	Type	25+	12+	6+	Each
12D06-180	424 (Soda)	67.95	71.95	75.95	79.95
12D06-166	424 (Juice)	-	82.95	85.95	89.95
12D06-210	464 (Soda)	82.95	87.95	92.95	97.95

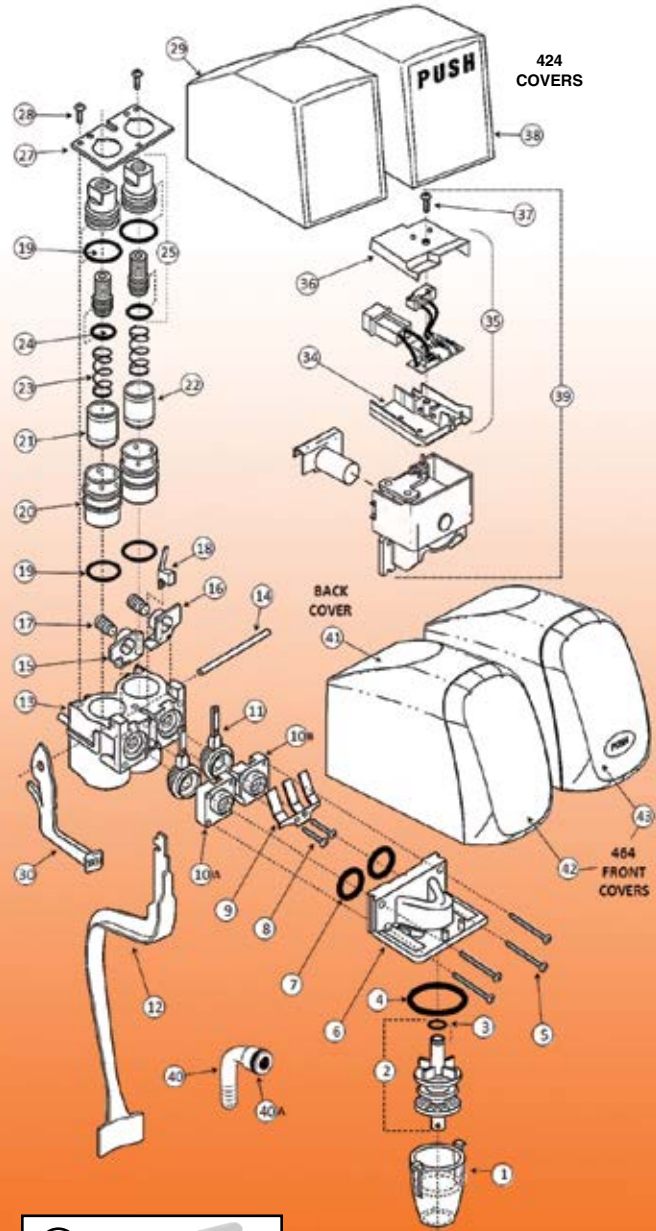

31-Mounting Block
 12D06-181 \$14.33
33-Quad Seal, stem
 12D06-228 \$0.52



Syrup Separator
 12D06-182
 \$10.69

Flomatic Faucet Replacement Parts

Additional price breaks available on most items. Login to your website account or contact your sales representative for pricing.

Ref. #	Catalog No.	Description	For Valve No.	Vendor Part No.	Each
1	12D06-168	NOZZLE (CLEAR)	424	501-24	3.08
1	12D06-169	NOZZLE (BLACK)	424	501-25	3.61
1	12D06-213	NOZZLE W/DIFFUSER (BLACK)	454/464	501-3181G	13.00
2	12D06-171	DIFFUSER ASSEMBLY	424/454	504-10	3.53
3	12D06-165	O-RING	424/454	543	0.15
4	12D06-172	O-RING	424	500	0.17
5	12D06-105	SCREW, #4-40 X 1 (S/S)	424/454/464	505	0.25
6	12D06-173	DIFFUSER BLOCK	424	507-26-B	7.69
6	12D06-215	DIFFUSER BLOCK	464	507-36-B	8.99
7	12D06-107	O-RING 1/2" (NEED 2 PC)	424/454/464	509	0.12
8	12D06-108	SCREW, #4-40 X 5/8 (S/S)	424/454/464	510	0.15
9	12D06-109	SPRING (PANT-LEG STYLE)	424/454/464	511	5.66
9	12D06-122	SPRING (COIL STYLE)	424/454/464	511-04	1.56
10A	12D06-110	ORIFICE CAP, SODA (LEFT)	424/454	512-01-B	1.18
10A	12D06-216	ORIFICE CAP, SODA (LEFT)	464	512-02-G	1.52
10B	12D06-174	ORIFICE CAP, SYRUP (RIGHT)	424/454	513-01-B	1.18
10B	12D06-217	ORIFICE CAP, SYRUP (RIGHT)	464	513-02-G	1.46
11	12D06-112	VALVE PALLET	424/454	515	4.55
11	12D06-111	VALVE PALLET	464	515-30	8.08
12	12D06-175	LEVER, PRODUCT (BLK PLASTIC)	424/454/464	516-09	2.81
12	12D06-218	LEVER, PRODUCT (S/S)	424/454/464	516-06	12.46
13	12D06-176	FLOW CONTROL BASE	424	600-06-B	13.17
13	12D06-219	FLOW CONTROL BASE	454/464	600-47-G	15.29
14	12D06-177	PIN-ACTUATOR PIVOT (LONG)	424/454/464	524-02	1.34
15	12D06-119	ACTUATOR, SYRUP (W/ADJ. SCREW)	424/454	521-02	3.06
16	12D06-120	ACTUATOR, SODA (W/ADJ. SCREW)	424/454	522-01	4.07
17	12D06-121	ADJ. SCREW, ACTUATOR	424/454	523	0.59
18	12D06-115	RETAINER, VALVE	424/454/464	517-04	0.87
19	12D06-178	O-RING	424	608	0.15
19	12D06-183	O-RING	454/464	5028272	0.15
20	12D06-179	CYLINDER, CERAMIC	424	602-02	18.45
20	12D06-220	CYLINDER, CERAMIC	454/464	602-03	32.55
21	12D06-185	PISTON, CERAMIC (SODA)	424	604-02	9.81
21	12D06-221	PISTON, CERAMIC (SODA)	454/464	604-03	15.74
22	12D06-184	PISTON, CERAMIC (SYRUP)	424	603-02	12.59
22	12D06-222	PISTON, CERAMIC (SYRUP)	454/464	603-02	12.59
23	12D06-186	SPRING, BRIX ADJ.	424/454	605-01	0.48
23	12D06-186	SPRING, BRIX ADJ. (SODA)	464	605-01	0.48
23	12D06-223	SPRING, BRIX ADJ. (SYRUP)	464	605-02	0.51
24	12D06-138	O-RING	424/454/464	551	0.15
25	12D06-187	BRIX ADJ. ASSEMBLY	424	642-00	3.41
25	12D06-188	BRIX ADJ. ASSEMBLY	454/464	643-00	4.36
27	12D06-189	RETAINER PLATE	424/454/464	610-04	1.49
28	12D06-191	BOLT, #4-40 X 1/4 (S/S W/LOCTITE)	424/454/464	501-3582	0.33
28	12D06-193	SCREW, SELF-TAPPING (S/S)	424/464	20001284	0.38
29	12D06-190	COVER, ELEC LEVER (BLK)	424	1521	9.82
30	12D06-192	ADD-A-LEVER (SODA)	424/454	1028S	9.44
30	12D06-224	ADD-A-LEVER (SODA)	464	1028S	9.44
30	12D06-203	ADD-A-LEVER (WATER)	424/454	1028W	8.63
30	12D06-225	ADD-A-LEVER (WATER)	464	1028W	8.63
31	12D06-181	MOUNTING BLOCK ASSEMBLY	424/454/464	380Q	14.33
33	12D06-228	QUAD SEAL, STEM	424/454/464	528	0.52
34	12D06-195	BASE, CONVERTIBLE SWITCH HOUSING	424/454/464	765-01	0.53
35	12D06-205	SWITCH ASSEMBLY (NEW STYLE)	424/454/464	5030420	9.23
36	12D06-196	COVER, CONVERTIBLE SWITCH HOUSING	424/454/464	766-01	0.50
37	12D06-198	SCREW, #6-32 X 5/8 (S/S)	424/454/464	2611	0.27
38	12D06-200	COVER, PUSH-BUTTON (BLACK)	424	1525	21.60
39	12D06-199	ELECTRIC SOLENOID (COMPLETE)	424/454/464	774-536	34.95
40	04T07-102	INLET FITTING (90 DEGREE)	424/454/464	-	1.90
40a	12T07-132	INLET O-RING	424/454/464	-	0.15
41	12D06-230	BACK COVER	464	1601	6.84
42	12D06-231	FRONT COVER (LEVER)	464	1602	5.32
43	12D06-232	FRONT COVER (PUSH BUTTON)	464	1610	DISCONTINUED

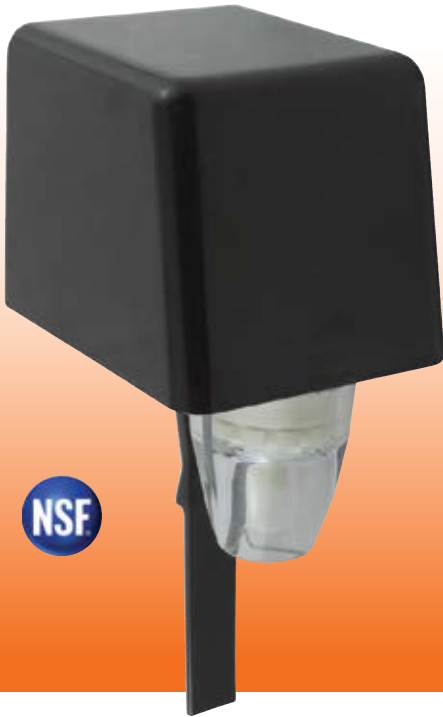

Flomatic Mechanical Valve



- Flow Rate: 1.5 oz. per second
- Mounting: 1/4" MFL (with mounting nut) x 2 ea.
- Non-electric design
- Easy-to-adjust brixing
- Simplistic design makes this unit inexpensive

12D06-150

12+ \$63.95 6+ \$66.95 Ea. \$70.95

Flomatic Mechanical Valve Replacement Parts

Additional price breaks available on most items. Login to your website account or contact your sales representative for pricing.

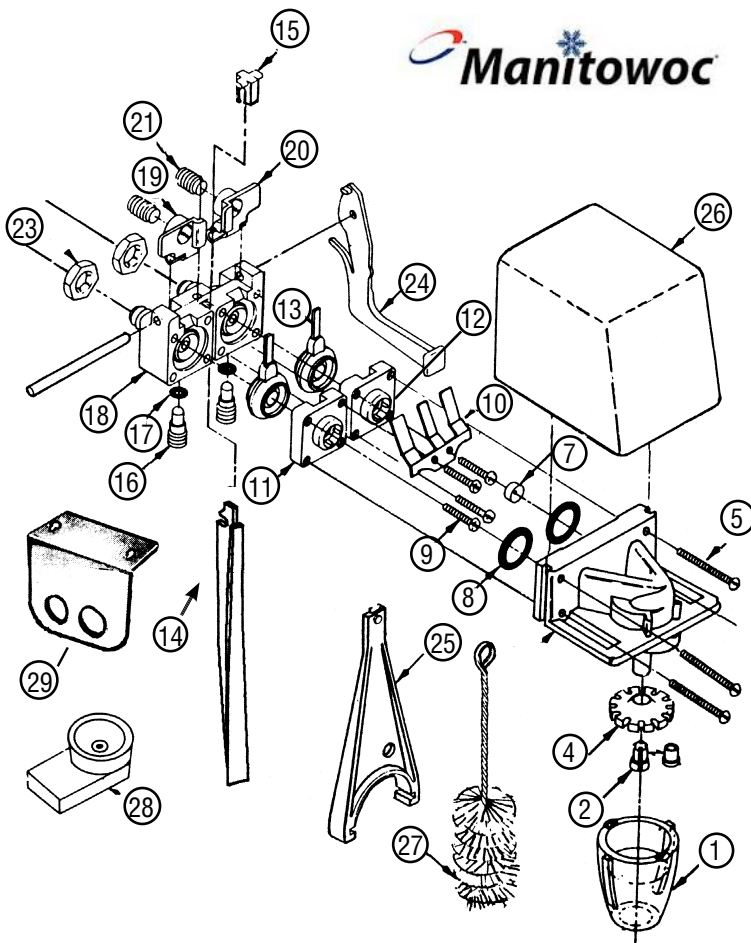

Ref. #	Catalog No.	Description	Each
1	12D06-101	Nozzle	5.00
2	12D06-143	Syrup Diffuser, soft pour	6.59
4	12D06-104	Diffuser Wheel, soda	2.64
5	12D06-105	1" x 4-40 S/S Screw	0.25
7	12C07-286	Flo Control Washer CLOSEOUT	2.95
8	12D06-107	1/2" O-ring (need 2)	0.12
9	12D06-108	5/8" 4-40 S/S Screw (need 4)	0.15
10	12D06-109	Pantleg Spring, 3 leg	5.66
11	12D06-110	Left Orifice Cap, soda	1.18
12	12D06-174	Right Orifice Cap, syrup	1.18
13	12D06-112	Valve Pallet (need 2)	4.55
14	12D06-227	Product Lever, black	2.92
15	12D06-114	Lever Retainer Cap, black	0.31
16	12D06-116	Metering Screw (need 2)	1.46
17	12D06-117	1/4" O-ring (need 2)	0.15

Standard Mount with Mounting Screws

18	12D06-118	Valve Base Assembly (1/4" MFL outlet)	19.03
19	12D06-119	Syrup Actuator w/#21	3.06
20	12D06-120	Soda Actuator w/#21	4.07
21	12D06-121	Adjusting Screw, Actuator	0.59
23	12D06-123	Mounting Nut (need 2)	1.13
24	12D06-124	Soda Add-a-lever	5.27
25	12D06-126	Wrench/actuator Tool	23.95
26	12D06-158	Cover "E" Black	6.27
27	12D06-127	Cleaning Brush	3.00
28	12D06-149	Syrup Separator	23.44
29	12D06-160	Undercounter Mounting Bracket	3.95



Syrup Separators



**LANCER
STANDARD FLOW LEV
VALVES**
12L01-101
5+ **\$9.50** Ea. \$9.95



**LANCER
FAST FLOW LEV
VALVES**
12L01-110
5+ **\$17.50** Ea. \$18.50



**LANCER
MULTI-FLAVOR
VALVES**
12L01-156
5+ **\$8.50** Ea. \$8.95



**INTL' CARBONIC
ALL PFC-II
VALVES**
12E09-101
Ea. **\$6.95**



**FLOMATIC
424 / 454 / 464
VALVES**
12D06-182
5+ **\$10.24** Ea. \$10.69



**FLOMATIC
MECHANICAL
VALVES**
12D06-149
5+ **\$22.45** Ea. \$23.44



**CORNELIUS
SF-1 / UF-1
VALVES**
12C07-249
5+ **\$15.58** Ea. \$16.50



**CORNELIUS
FLAVOR FUSION
VALVES**
12C07-250
5+ **\$51.95** Ea. \$54.95

Additional price breaks available on most items. Login to your website account or contact your sales representative for pricing.



**DOLE
FAST FLOW FFV
VALVES**
12A06-245
5+ **\$18.86** Ea. \$19.97



**WUNDER-BAR
ALL SERIES BARGUN
VALVES**
12Q08-112
5+ **\$10.11** Ea. \$10.95



**SCHROEDER
ALL BARGUN
VALVES**
12F01-100
5+ **\$13.92** Ea. \$14.74

Brix Cups

Used to measure the ratio of syrup to water in a drink. A syrup separator is attached to the head of the valve and the brix cup is placed below the separator. When the valve is engaged, syrup should flow into the smaller tube while water should flow into the larger tube.

Ref.#	Catalog No.	Reg. Syrup	Diet Syrup	10+	5+	Each
1	12T07-186	5 to 1 Ratio (Standard)	5.5 to 1 ratio	14.96	15.84	16.83
1	12T07-188	4.75 to 1 Ratio (McDonald's)	5.5 to 1 ratio	17.47	18.19	19.39
2	12L01-133	5 to 1 Ratio (Coca Cola)	5.5 to 1 ratio	38.50	40.50	42.50



Syrup Separators and Brix Cups

LANCER Post-Mix Dispensers

Post-Mix Soda Dispensers



MODEL: CED 500

- Stainless steel cabinet, water bath, product lines and drip tray assembly
- Insulation is CFC free structural foam, removable refrigeration deck
- Occupies a small area of counter space 10-3/8" W
- R134A refrigerant
- 1/4 hp
- 17 lb. ice bank, flooded manifold



SHIPS DIRECTLY FROM THE MANUFACTURER

DIMENSIONS: 10-3/8" W x 25-1/4" D x 23" H.
ELECTRICAL: 115VAC/60Hz 7 AMP
SHIPPING WEIGHT: 108 lbs.

PURCHASE CARBONATOR SEPARATELY

11L07-105 4-VALVE **\$1450.00**



MODEL: CED 1500 STD

- Stainless steel cabinet, water bath, product lines and splash tray
- Insulation is CFC free structural foam
- R134A refrigerant
- 1/3 hp
- 30 lb. ice bank, flooded manifold
- Optional lighted front marquee kit



SHIPS DIRECTLY FROM THE MANUFACTURER

DIMENSIONS: 19-6/32" W x 24" D x 25-3/8" H
ELECTRICAL: 115VAC/60Hz 4.5 AMP
SHIPPING WEIGHT: 150 lbs.

PURCHASE CARBONATOR SEPARATELY

11L07-106 6-VALVE **\$1935.00**

LANCER Ice/Drink Dispensers

- Industry standard widths of 22" and 30" respectively
- Unique hex-drive ice agitation for trouble-free operation
- Heavy duty stainless steel cabinet construction
- High capacity ice storage bin
- Fully insulated ice storage bin and drip tray
- Plumbing access front and rear for installation flexibility
- Illuminated interchangeable front graphics
- LEV® sanitary lever or push-button valves



Model: IBD 4500



SHIPS DIRECTLY FROM THE MANUFACTURER

- 6 VALVE DIMENSIONS: 22" W x 30-1/2" D x 35-3/8" H.
- 8/10 VALVE DIMENSIONS: 30" W x 30-1/2" D x 35-3/8" H
- 6 VALVE ICE CAPACITY: 180 lbs
- 8/10 VALVE ICE CAPACITY: 250 lbs.
- ELECTRICAL: 115VAC/60Hz 3 AMP
- FITTINGS: 3/8" Barb inlets
- VALVES: LEV® model
- SHIPPING WEIGHTS: 6 Valve is 255 lbs; 8/10 Valve is 305 lbs.



PURCHASE CARBONATOR SEPARATELY

11L07-107 6 VALVE 3/2/1 **\$2569.00**

11L07-110 8 VALVE 3/1/1/3 **\$3150.00**

11L07-112 10 VALVE 3/1/2/1/3 **\$3689.00**



LANCER In-Counter / Drop-in Postmix Dispensers

Model: ICD 2200 STD

- Available with 5 or 6 valves
- Stainless steel construction with sealed-in cold plate, 3/4" drain with strainer
- Stainless steel flooded soda manifold and multiple plain water configurations
- Ice bin insulated with CFC free structural foam
- Tower designed with removable splash plate and drip tray for easy cleaning
- Optional top merchandiser and back marquee featuring lighted graphics



Model: ICD 2300 STD

- Available with 8 valves
- Stainless steel construction with sealed-in cold plate, 3/4" drain with strainer
- Stainless steel flooded soda manifold and multiple plain water configurations
- Ice bin insulated with CFC free structural foam
- Tower designed with removable splash plate and drip tray for easy cleaning
- Optional top merchandiser and back marquee featuring lighted graphics



SHIPS DIRECTLY FROM THE MANUFACTURER

DIMENSIONS: 15" W x 23" D x 33-3/8" H • COUNTER CUT-OUT: 15-1/4" x 23-1/4"
 ICE CAPACITY: 60 lbs. • ELECTRICAL: 24VAC/60Hz • FITTINGS: 3/8" Barb inlets
 VALVES: LEV® model • SHIPPING WEIGHT: 130 lbs.

11L07-116 5 VALVE 2/2/1 \$1475.00
11L07-117 6 VALVE 3/2/1 \$1465.00

SHIPS DIRECTLY FROM THE MANUFACTURER

DIMENSIONS: 23" W x 23" D x 36-1/4" H • COUNTER CUT-OUT: 23-1/4" x 23-1/4"
 ICE CAPACITY: 100 lbs. • ELECTRICAL: 24VAC/60Hz • FITTINGS: 3/8" Barb inlets
 VALVES: LEV® model • SHIPPING WEIGHT: 150 lbs.

11L07-118 8 VALVE 3/1/1/3 \$1825.00

McCann's Drop-In Conversion Stands

Sturdy stainless steel construction • Shipped UPS unassembled

SHIPS DIRECTLY FROM THE MANUFACTURER

Catalog No.	Description	Each
11T07-101	Fits Drop-in Units 15" x 23"	299.00
11T07-100	Fits Drop-in Units 23" x 23"	275.00

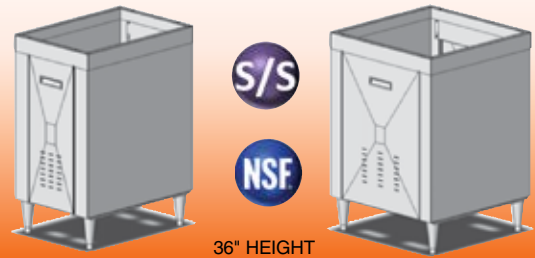

36" HEIGHT

Ice/Drink Dispenser Replacement Parts



FOXX EQUIPMENT CAN SUPPLY PARTS FOR VIRTUALLY ALL MANUFACTURERS OF ICE AND DRINK DISPENSERS!
 Call your sales representative with model and serial number



"IBIS" Soda or Water Fountain Faucets

FOR DISPENSING CARBONATED WATER OR NONCARBONATED WATER

Counter top to faucet spout tip: 12" • Tip of spout back to base: 6" • Mounting shank: 1 1/4" diameter x 4 1/2" length • 1/4" barb connections

"IBIS" Soda/Water Fountain Faucets



CHROME
PLATED
BRASS
BODY

1-FAUCET
12C03-208
\$289.95



STAINLESS
STEEL
CONTACT
WITH
WATER

2-FAUCET
12C03-209
\$389.95



ADJUSTABLE
FLOW
CONTROL
FAUCETS

3-FAUCET
12C03-210
\$570.95

Additional price breaks available on most items. Login to your website account or contact your sales representative for pricing.

"IBIS" Replacement Parts

FOR DISPENSING CARBONATED WATER OR NONCARBONATED WATER



ADJUSTABLE FLOW
CONTROL
FAUCET
(SELF-CLOSING)

12C03-300
\$36.95



FLOW
CONTROL
SHANK
(2-1/2" W/LINER)

12C03-301
\$10.95



SHANK
WASHER

12C03-305
\$0.50



FAUCET
COUPLING
NUT

12C03-303
\$4.73



STAINLESS
STEEL
SPACER
(1-3/4" LENGTH)

12C03-302
\$11.95

Agitator Motors FOR ALL MODEL ICE BANK COOLING UNITS

BOXED WITH:
11pc #8-36 screws (for mounting)

Up to 50% more efficient than other shaded pole motors

BEFORE BUYING, CHECK FOR:

- Rotation & watts (stamped into face-plate)
- Shaft length & blade mount

BLADES AND MOTORS SOLD SEPARATELY



	Catalog No.	Rotates	Output	Shaft Length	Volts	4+	2+	Each
FLATTED	19Q06-106	CCW	15w	5"	115	DISCONTINUED		45.95
	19Q06-108	CCW	15w	7"	115	82.95	84.95	86.95

MOTOR DIMENSIONS:
3-25/32" Diameter
3-9/64" deep

	Catalog No.	Rotates	Output	Shaft Length	Volts	4+	2+	Each
PIN HOLE	19Q06-101	CW	15w	8 1/2"	115	75.95	77.95	79.95
	19Q06-104	CCW	15w	7"	115	72.95	75.95	77.95
	*19Q06-107	CCW	25w	7"	115	74.95	76.95	78.95
	*19Q06-114	CCW	25w	7"	230	81.95	83.95	86.95

Uses Pin	Each
19E03-101	0.25
19E03-102	0.25
19E03-102	0.25
19E03-102	0.25

	Catalog No.	Rotates	Output	Shaft Length	Volts	4+	2+	Each
THREADED	**19Q06-103	CCW	15w	5"	115	72.95	75.95	77.95
	**19Q06-105	CCW	15w	7"	115	74.95	76.95	78.95

Catalog No.	Description	Each
19Q06-112	Washer	0.45
19Q06-110	Nut	0.30

* MULTIPLEX

** CORNELIUS

Replacement Blades



Ref.#	Catalog No.	Fits Shaft	Each
1	19A01-201	Flatted	2.00
2	19C07-107	Pin Hole	5.38
3	19Q06-111	Threaded	9.50
4	19Q06-109	All	2.41

K-Way Replacement Soda Parts

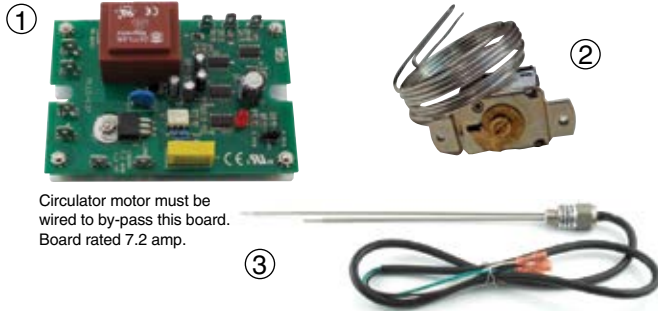

Circulator motor must be wired to by-pass this board. Board rated 7.2 amp.

Ref.	Catalog No.	Description	6+	3+	Each
1	09K05-102	Liquid Level Control	60.95	64.95	68.95
2	19S05-124	Thermostat (soda)	50.95	52.95	54.95
3	09S05-195	Probe Carbonator	33.95	34.95	36.95

Submersible Agitator Motor



Little GIANT

115V/60Hz 0.8AMP
1 PHASE

09B04-111 \$108.95

Works with most ICI units

1/5HP "Li'l Fella 12"	1/5HP "Topper"	3/8HP "VSC-II"
1/5HP "Li'l Fella 23"	1/5HP "Topper II"	3/8HP "Big Fella"

Submersible Agitator Pump



beckett

MULTI-PURPOSE APPLICATION

- Ball bearings perm lubed
- Overload protected
- Durable all steel gear

Catalog No.	GPH	Outlet	4+	2+	Each
09B04-108	150	1/4" NPT	38.95	40.95	42.95
09B04-105	300	1/4" NPT	40.95	43.95	45.95



Replacement Transformer

24V, 75V, 120V, 50/60hz

12T07-190

4+ \$19.95

2+ \$20.95 Ea. \$21.95

Motorless Carbonating/Nitrogenating Tanks

PERFECT FOR CARBONATING ANY PRODUCT • PERFECT FOR NITROGENATING COLD BREW COFFEE

MANUFACTURED USING A.E.B. HIGH QUALITY PRODUCT TANKS

Agitating tanks also available — Call your sales representative for complete details

CHARGE WITH DESIRED GAS UP TO 100 LB. AND IN A FEW MINUTES, YOUR PRODUCT IS READY TO GO



Catalog No.	Description	10+	5+	Each
09C03-119	2.5 gal. Carb/Nitro Tank (strap handle)	137.95	141.95	145.95
09C03-233	3 gal. Carb/Nitro Tank (strap handle)	140.95	144.95	148.95
09C03-235	5 gal. Carb/Nitro Tank (strap handle)	144.95	149.95	154.95

Catalog No.	Description	10+	5+	Each
09C03-120	2.5 gal. Carb/Nitro Tank (rubber top)	141.95	145.95	149.95
09C03-238	3 gal. Carb/Nitro Tank (rubber top)	144.95	148.95	152.95
09C03-236	5 gal. Carb/Nitro Tank (rubber top)	149.95	154.95	159.95

Carbonating/Nitrogenating Lid

USE WITH ANY PRODUCT TANK TO CREATE A MOTORLESS CARBONATING/NITROGENATING TANK



MODIFIED A.E.B. LID with BALL-LOCK CONNECTION

ADD TO ANY EXISTING 2.5, 3 OR 5 GALLON PRODUCT TANK CHARGE WITH DESIRED GAS UP TO 100 LB. AND IN A FEW MINUTES, YOUR PRODUCT IS READY TO GO

25+ \$35.95

15D04-100 10+ \$37.95 5+ \$39.95 Ea. \$41.95

Carbonating/Nitrogenating Stones

USE WITH ANY PRODUCT TANK TO CREATE A MOTORLESS CARBONATING/NITROGENATING TANK



FLARE DIP TUBE AFTER TANK INSTALLATION



WITH CHECK VALVE

1/4" MFL



NO CHECK VALVE

1/4" BARB

Catalog No.	Description	25+	10+	5+	Each
09C03-125	Carbstone w/Dip Tube (has check valve)	33.95	34.95	35.95	37.95
09D03-125	Carbstone, 1/4"MFL (has check valve)	17.95	18.95	19.95	20.95
09C03-001	Carbstone, 1/4" Barb (no check valve)	6.95	7.95	8.95	9.95

Delta 9100 HP Remote Recirculating Refrigeration System

DELTA 9100 IS A BENCHMARK IN THE FOUNTAIN DISPENSING MARKET

LANCER®

PROVIDES OPTIMUM TEMPERATURE PRODUCT TO A REMOTE DISPENSING TOWER LOCATION

- 6 syrup coils to supply up to 6 valves
- 25-28 lb. ice bank weight
- Min. flowing pressure of 25 PSIG
- Max. static pressure of 50 PSIG
- Electronic ice bank control
- Electronic liquid level control
- CFC free refrigerant
- CO₂ requirements: min. pressure 70 PSIG
Max. pressure 80 PSIG
- Water requirements: min. flow 25 PSIG
Max. static pressure 50 PSIG
- Dimensions: 26"H x 16.5"W x 25.5"D
- Electrical: 115V / 60Hz
- Weight: 156 lb. empty, 200 lb. operating



SHIPS DIRECT FROM THE MANUFACTURER

09L07-100 **\$2015.00**



Soda Factory™ Remote Recirculating Refrigeration System

PRODUCES COLD CARBONATED WATER AND CHILLS INCOMING WATER AND SYRUP PRIOR TO DELIVERY

MULTIPLEX®

PROVIDES OPTIMUM TEMPERATURE PRODUCT TO A REMOTE TO DISPENSING TOWER

- 12 oz. drink cap per hour at or below 40°F
- 108 Peak (for 2 hours) 60 sustained
- 6 syrup coils to supply up to 6 valves
- 28 lb. ice bank
- 1/3 HP compressor
- R-404A refrigerant
- 40' maximum run length
- Dimensions: 18.5"H x 27.75"W x 16.5"D
- Electrical: 120V / 60 Hz



Model 2803



SHIPS DIRECT FROM THE MANUFACTURER

09D07-100 **\$2865.00**

Flash Chillers for B-I-B Syrups, Water and Beer

DESIGNED TO PRE-CHILL SYRUPS AND WATER—CAN BE ADDED TO EXISTING GLYCOL SYSTEM FOR ADDITIONAL COOLING

TAYFUN T75

- 1 to 3 product lines
- Maximum distance 25'
- 1/4 HP compressor
- 22 lb. ice bank
- R134a refrigerant
- 115V / 60Hz
- 550 watt consumption
- Requires 10 amp dedicated circuit
- 75 lb. weight
- 15" W x 16" D x 28" H



19U07-300
\$895.00

TAYFUN T160

- 1 to 6 product lines
- Maximum distance 25'
- 1/2 HP compressor
- 53 lb. ice bank
- R134a refrigerant
- 115V / 60Hz
- 800 watt consumption
- Requires 15 amp dedicated circuit
- 125 lb. weight
- 32" W x 19" D x 23" H



19U07-302
\$1169.00



McCann's Carbonators

CARBONATORS LISTED HAVE **ASSE 1022** SPECIFIED BACKFLOW PREVENTER

FREE FREIGHT ON 12 CARBONATORS — SHIPS FROM MANUFACTURER



Carbonators and Replacement Parts

SPECIFICATIONS FOR LISTED CARBONATORS

- Solid state 2 pc. float/probe liquid level control
- "Diamond Brite" tank with 5 year warranty
- 1/3 HP motor/115VAC 60Hz/7 amps
- 1/4" MFL CO₂ inlet, 3/8" MFL water inlet, 3/8" soda outlet(s)



Retrofit Kit VENTED BACKFLOW PREVENTER

For all "Big Mac" Carbonators

09T07-120 \$79.95

Ref. #	Catalog No.	Description	Tank Cap	Outlets	Height	Width	Depth	Ship Weight	12+	6+	3+	Each
1	09T07-111	Small Carbonator	32 oz.	1	11"	9"	11-1/2"	25 lbs	362.95	373.95	381.95	390.95
2	09T07-107	Big Mac	2 gallon	2	10-1/2"	14"	13"	28 lbs	380.95	390.95	400.95	409.95
2	09D03-101	Big Mac (Stainless)	2 gallon	2	10-1/2"	14"	13"	28 lbs	-	472.95	484.95	497.95

McCann's Carbonator Replacement Parts



Electronic Probe

09T07-100
\$89.95



Electronic Probe Conversion Kit

09T07-101
\$106.95

PROCON®



Procon Pump
100GPH – 250 PSI

09H02-134
\$57.95



1/3 HP Motor
Welded Base

09D08-200
\$81.95



Fittings Kit
for Carbonators

09D03-103
\$7.50

Additional price breaks available on most items. Login to your website account or contact your sales representative for pricing.



Vented Backflow Preventer
3/8" MPT x 3/8" MFL (1/4" B vent)

09T07-105
\$29.95



Rebuild Kit for
Backflow Preventer

09T07-106
\$22.95



Check Valve 1/4" MFL
Gas Inlet

09C03-200
\$3.97



Pressure Relief
180 PSI

09C03-210
\$4.05



SCHROEDER America Carbonator
MORE DURABLE & RELIABLE



FEATURES

- A fully solid state 2pc control module with zero moving parts provides a more durable, long lasting component over conventional float/switch designs
- 2.5 gallon stainless steel tank for durability and ease of cleaning
- NSF listed rotary vane pump has a built-in strainer and rated at 100 GPH
- Stainless steel base for improved durability

SPECIFICATIONS

- 115V / 60 Hz / 1725 rpm
- 2.5 gallon tank
- 100 GPH pump with strainer
- 240 PSI pressure relief valve
- ETL approved
- Inlet: 1/4" MFL & Outlet: 3/8" MFL(s)
- * Weight: 30 lb.
- Dimensions: 14.75" W x 13" D x 11" H

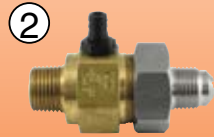

ASSE 1022



Intertek

RETRO-FIT TO McCANN'S CARBONATORS

Ref.	Catalog No.	Description	12+	6+	3+	Each
1	09S07-100	Carbonator 2.5 gallon (110V)	345.95	355.95	365.95	375.95
2	09T07-105	Back Flow Preventer (ASSE 1022 and Low Lead Compliant)	25.95	26.95	28.95	29.95
3	09S07-101	Control Module only (Probe not included)	68.95	72.95	74.95	76.95
3,4	09S07-102	Retro-Fit Kit (to adapter to McCann's Carbonators) Includes: Ref. 3,4 + Cap and Plug Adapters	99.95	105.95	107.95	111.95

cerrowire 3-Wire 300-Volt Black SJ00W Line Cord

FOR COMMERCIAL OR RESIDENTIAL USE • VERY FLEXIBLE • DAMAGE RESISTANT

Catalog No.	Description	250 Roll	100'+	25'+	10'+	Per Ft.
10Z01-102	16 Gauge 3-wire Line Cord	0.59	0.64	0.68	0.72	0.76
10Z01-101	14 Gauge 3-wire Line Cord	0.91	0.99	1.05	1.11	1.17



Ref.#	Catalog No.	Description	20+	10+	5+	Each
1	20N09-101	Electrical Tape 3/4" W x 60' L	0.65	0.68	0.71	0.75
Ref.#	Catalog No.	Description	100+	25+	10+	Each
2	10Z01-103	Connector 16-18 Gauge	0.08	0.09	0.10	0.15
3	10Z01-104	Connector 12-14 Gauge	0.13	0.14	0.15	0.20

Ref.#	Catalog No.	Description	100+	50+	25+	Each
4	10E03-102	Eyelet 3/16" 18-22 Gauge	0.13	0.14	0.15	0.20
5	10E03-104	90° Spade 14-16 Gauge	1.10	1.20	1.30	1.40
Ref.#	Catalog No.	Description	25+	10+	Each	
6	10Z01-105	Female Receptacle 3-wire	6.25	6.55	6.95	
7	10Z01-106	Male Plug 3-wire	3.95	4.25	4.50	

Electric Carbonator Motors

Carbonator Motors and Shelving



①

Welded Base – 1/3 HP Single Voltage

- 1725 RPM
- 115V / 60Hz
- Automatic Overload
- 48Y Frame



②

Resilient Base – 1/3 HP Dual Voltage

- 1725 RPM
- 115V/230V 60Hz
- Automatic Overload



③

Resilient Base – X/X HP Single or Dual Voltage

- 1725 RPM
- 115V / 60Hz or 115V/230V 60Hz
- Automatic Overload

Ref.#	Catalog No.	Description	12+	6+	Each
1	09D08-200	1/3 HP (115V) Welded	70.95	74.95	81.95
2	09D08-203	1/3 HP (115V/230V) Resilient	123.95	131.95	143.95
-	-	-	-	-	-

Ref.#	Catalog No.	Description	12+	6+	Each
3	09D08-101	1/4 HP (115V)	115.95	123.95	134.95
3	09D08-102	1/3 HP (115V)	98.95	104.95	114.95
3	09D08-103	1/3 HP (115/230V) 60/50 Hz	137.95	147.95	160.95
3	09D08-105	1/2 HP (115V/230V)	152.95	163.95	178.95

Service Cords: 3-Wire 16 Gauge



10E03-100
6' Length
 10+ **\$5.32**
 5+ \$5.65 Ea. \$5.95

ROUND CABLE



10E03-103
8' Length
 10+ **\$6.61**
 5+ \$7.02 Ea. \$7.37

ROUND CABLE

Additional price breaks available on most items. Login to your website account or contact your sales representative for pricing.

Carbonator/Water Booster Shelving



WALL MOUNT

All stainless steel construction
 Easy to assemble and clean
 10-1/4" H x 14-5/8" L x 13-1/8" D

15T07-125 \$70.95



FLOOR/WALL MOUNT

Welded steel construction
 Powder coat finish
 8" H x 19-1/4" L x 12-1/4" D

15F09-120 \$36.95

HOLES FOR MCCANN'S & LANCER CARBONATORS

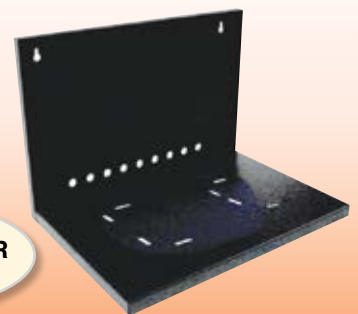

WALL MOUNT

Welded steel construction
 Powder coat finish
 13-1/4" H x 19" L x 13-1/4" D

15F09-119 \$50.95



PROCON® Mag Drive Pump/Motor Assembly

NO MECHANICAL SEAL TO FAIL

LEAK FREE DESIGN

MAGNETICALLY COUPLED

STAINLESS STEEL CONSTRUCTION

FOR CIRCULATING CARBONATED WATER

- Direct drop-in for most standard pump and motor packages
- Motor voltage: 115/230 VAC 50/60 Hz
- Motor speed: 1360 RPM - 50 Hz / 1660 RPM - 60 Hz
- Pump relief setting: 100 PSI
- Pump ports: 3/8" FPT
- NSF listed pump
- Dimensions: 9" L x 4 1/4" W x 6" H
- Weight: 10 lbs.



NSF
PROCON PUMP

09H02-300 **\$272.95**

PROCON® Pump Insulation and Accessories

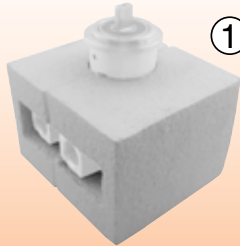

①

STYROFOAM INSULATION

For use with Series 2 and 3 Pumps



②

V-BAND CLAMP

For use with clamp-on Pumps



③

HVY-DUTY V-BAND CLAMP

For use with clamp-on pumps



④

BRONZE COUPLING SHAFT

For use slitted shafts



⑤

STRAINER SCREEN

For use with Series 1 Pumps

Ref.#	Catalog No.	Description	25+	10+	Each
1	09C07-125	Styrofoam Pump Insulation	14.95	14.95	16.95
2	09H02-101	V-Band Pump Clamp	1.30	1.50	1.75
3	09H02-103	Hvy-Duty V-Band Pump Clamp	5.95	6.50	6.95

Ref.#	Catalog No.	Description	25+	10+	Each
4	09H02-114	Bronze Double-Flatted Coupling	4.08	4.32	4.59
5	09H02-123	Strainer Screen	1.25	1.50	1.75

Additional price breaks available on most items. Login to your website account or contact your sales representative for pricing.

PROCON® Adapter for 56C Frame Motors

CONNECTS A PROCON® BOLT-ON STYLE PUMP WITH A SINGLE FLAT 7/16" DIA. SHAFT TO MOST BRANDS OF 56C FRAME MOTORS

09H02-133
Adapter
\$31.95



Martin
THIS MARTIN® 3-PC COUPLER CONNECTS THE PROCON® PUMP TO A 5/8 DIA. SHAFT ON 56C FRAME MOTORS

09H02-112 **\$23.95**

PROCON® Rotary Vane Fluid Pumps

All pumps have a nominal speed of 1,725 RPM and a maximum discharge pressure of 250PSI.
All pumps listed here have a clockwise rotation and an adjustable relief range (if available).

There is a multitude of configuration possibilities available. Contact your sales representative for pricing and availability if you do not see the pump you want.



SERIES 1



SERIES 2



SERIES 3

Special discounted pricing on case qtys. drop-shipped from the manufacturer. Contact your sales representative for pricing.

SERIES 1 Has a brass body and is designed for operating flow rates of 15 GPH to 140 GPH. This series also has an integral 100 mesh strainer. Strainer removes harmful particulates from incoming flow.

Catalog No.	Manufacturer No.	Mount	Drive Coupler	Flow Rate GPH	Seal	Relief Setting	12+	6+	Each
09H02-125	101E100F11BA170	Bolt-on	Single Flat S/S	100 gph	Nitrile	170 psi	53.95	55.95	57.95
09H02-185	101E070R11BC080	Bolt-on	Single Flat S/S	70 gph	Fluorocarbon	80 psi	53.95	55.95	57.95
09H02-124	101A050F11AA170	Clamp-on	Double Flat S/S	50 gph	Nitrile	170 psi	53.95	55.95	57.95
09H02-186	101B070R11BC080	Clamp-on	Double Flat Bronze	70 gph	Fluorocarbon	80 psi	53.95	55.95	57.95
*09H02-102	111A100F11BA170	Clamp-on	Double Flat S/S	100 gph	Nitrile	170 psi	53.95	55.95	57.95
*09H02-134	111A100F11AA250	Clamp-on	Double Flat S/S	100gph	Nitrile	250 psi	53.95	55.95	57.95
*09H02-234	111B100F31AA250	Clamp-on	Double Flat Bronze	100 gph	Nitrile	250 psi	80.95	84.95	87.95
09H02-146	101B100F11BC099	Clamp-on	Double Flat Bronze	100 gph	Nitrile	99 psi	53.95	55.95	57.95
09H02-176	101C100F11BC060	Clamp-on	Double Flat Plastic	100 gph	Nitrile	60 psi	53.95	55.95	57.95

SERIES 2 Has a brass body and is designed for operating flow rates of 15 GPH to 140 GPH. This series is the same as the Series 1 pumps but does not have an integral strainer. Some models stocked have a balance relief valve.

Catalog No.	Manufacturer No.	Mount	Drive Coupler	Flow Rate GPH	Seal	Relief Setting	12+	6+	Each
09H02-118	102E100F11BA170	Bolt-on	Single Flat S/S	100 gph	Nitrile	170 psi	51.95	53.95	56.95
*09H02-115	112A015F11DB130#	Clamp-on	Double Flat S/S	15 gph	Nitrile	130 psi	51.95	53.95	56.95
*09H02-166	112A025F11DB130#	Clamp-on	Double Flat S/S	25 gph	Nitrile	130 psi	51.95	53.95	56.95
*09H02-148	112A035F11DB130#	Clamp-on	Double Flat S/S	35 gph	Nitrile	130 psi	51.95	53.95	56.95
09H02-170	102A050F11AA170	Clamp-on	Double Flat S/S	50 gph	Nitrile	170 psi	51.95	53.95	56.95
*09H02-144	112A060F11DB130#	Clamp-on	Double Flat S/S	60 gph	Nitrile	130 psi	51.95	53.95	56.95
*09H02-159	112A070F11AA170	Clamp-on	Double Flat S/S	70 gph	Nitrile	170 psi	51.95	53.95	56.95
09H02-108	102D100F11BD055	Clamp-on	Without Coupler	100 gph	Nitrile	55 psi	51.95	53.95	56.95
*09H02-104	112A100F11BA170	Clamp-on	Double Flat S/S	100 gph	Nitrile	170 psi	51.95	53.95	56.95
09H02-116	102A100R11BB130	Clamp-on	Double Flat S/S	100 gph	Fluorocarbon	130 psi	51.95	53.95	56.95
09H02-110	102A125F11XX	Clamp-on	Double Flat S/S	125 gph	Nitrile	No Relief	51.95	53.95	56.95

WITH BALANCE RELIEF VALVE

SERIES 3 Has a stainless steel body and is designed for operating flow rates of 15 GPH to 140 GPH. This series is the same as the Series 1 pumps but does not have an integral strainer.

Catalog No.	Manufacturer No.	Mount	Drive Coupler	Flow Rate GPH	Seal	Relief Setting	12+	6+	Each
*09H02-122	113E100F31BA170	Bolt-on	Single Flat S/S	100 gph	Nitrile	170 psi	100.95	104.95	109.95
*09H02-174	113A050F31XX	Clamp-on	Double Flat S/S	50 gph	Nitrile	No Relief	100.95	104.95	109.95
*09H02-130	113A100F31XX	Clamp-on	Double Flat S/S	100 gph	Nitrile	No Relief	100.95	104.95	109.95
*09H02-230	113B100F31XX	Clamp-on	Double Flat Bronze	100 gph	Nitrile	No Relief	125.95	130.95	134.95
*09H02-106	113A100F31BA170	Clamp-on	Double Flat S/S	100 gph	Nitrile	170 psi	100.95	104.95	109.95

PROCON® Rotary Vane Fluid Pumps

All pumps have a nominal speed of 1,725 RPM and a maximum discharge pressure of 250PSI.
All pumps listed here have a clockwise rotation and an adjustable relief range (if available).

There is a multitude of configuration possibilities available. Contact your sales representative for pricing and availability if you do not see the pump you want.



SERIES 4



SERIES 5

ESPRESSO MACHINE PUMP



SERIES 7

Special discounted pricing on case qtys. drop-shipped from the manufacturer. Contact your sales representative for pricing.

SERIES 4 Has a brass body and is designed for operating flow rates of 115 GPH to 330 GPH. This series is constructed the same as Series 2 only larger in size. Has 1/2" FPT ports.

Catalog No.	Manufacturer No.	Mount	Drive Coupler	Flow Rate GPH	Seal	Relief Setting	12+	6+	Each
09H02-156	104E140F11BA170	Bolt-on	Single Flat S/S	140 gph	Nitrile	170 psi	108.95	112.95	117.95
09H02-128	104E240F11XX	Bolt-on	Single Flat S/S	240 gph	Nitrile	No Relief	108.95	112.95	117.95
09H02-132	104E240F11BA170	Bolt-on	Single Flat S/S	240 gph	Nitrile	170 psi	108.95	112.95	117.95
09H02-136	104B240F11XX	Clamp-on	Double Flat Bronze	240 gph	Nitrile	No Relief	108.95	112.95	117.95
09H02-126	104B240F11BA170	Clamp-on	Double Flat Bronze	240 gph	Nitrile	170 psi	108.95	112.95	117.95
09H02-158	104B240R11BB130	Clamp-on	Double Flat Bronze	240 gph	Fluorocarbon	130 psi	108.95	112.95	117.95
09H02-178	104C240F11BC099	Clamp-on	Double Flat Plastic	240 gph	Nitrile	99 psi	108.95	112.95	117.95
09H02-179	10543 OEM PUMP	Clamp-on	Double Flat Plastic	240 gph	Nitrile	99 psi	155.95	161.95	168.95

SERIES 5 Has a stainless steel body and is designed for operating flow rates of 115 GPH to 330 GPH. This series is constructed the same as Series 3 only larger in size. Has 1/2" FPT ports.

Catalog No.	Manufacturer No.	Mount	Drive Coupler	Flow Rate GPH	Seal	Relief Setting	12+	6+	Each
09H02-131	105E240F31XX	Bolt-on	Single Flat S/S	240 gph	Nitrile	No Relief	129.95	135.95	140.95
09H02-140	105E240F31BA170	Bolt-on	Single Flat S/S	240 gph	Nitrile	170 psi	129.95	135.95	140.95
09H02-142	105B240F31XX	Clamp-on	Double Flat Bronze	240 gph	Nitrile	No Relief	129.95	135.95	140.95
09H02-138	105B240F31BA170	Clamp-on	Double Flat Bronze	240 gph	Nitrile	170 psi	129.95	135.95	140.95
09H02-168	105B240R31BB130	Clamp-on	Double Flat Bronze	240 gph	Fluorocarbon	130 psi	129.95	135.95	140.95

SERIES 6 Has a stainless steel body and is designed for operating flow rates of 300 GPH to 660 GPH. This series is available only in bolt-on and has no integral strainer or relief. Has 1" FPT ports.

**THIS ITEM IS NON-STOCK AND WILL BE SHIPPED DIRECTLY FROM THE MANUFACTURER.
CALL YOUR REPRESENTATIVE FOR AVAILABLE MODELS AND PRICING.**

SERIES 7 Has a brass body and is designed for operating flow rates of 15 GPH to 140 GPH. This series is constructed the same as Series 2 only more compact in size with a lower height. Has 3/8" FPT ports.

Catalog No.	Manufacturer No.	Mount	Drive Coupler	Flow Rate GPH	Seal	Relief Setting	12+	6+	Each
*09H02-180	117A015F11CB120	Clamp-on	Double Flat S/S	15 gph	Nitrile	120 psi	64.95	67.95	69.95

Vented Backflow Preventers



Ref. #	Catalog No.	Description	Inlet	Flow	Outlet	25+	10+	Each
1	09T07-105	Anderson Brass (1/4" barb vent)	3/8" MPT	→	3/8" MFL	26.95	28.95	29.95
2	09K06-115	Watts Stainless Steel (Model SD3)	3/8" FPT	→	3/8" MFL	59.95	62.95	64.95
-	09K06-116	Repair Kit for SD3	-	-	-	17.25	17.95	19.25
-	09K06-117	Strainer only for SD3	-	-	-	6.12	6.50	6.95
3	04C03-225	Hose Barb, S/S (1/8" MPT x 1/4" B)	-	-	-	1.99	-	2.08
4	09K06-109	Watts Stainless Steel (Model 9BD)	3/8" MFL	→	3/8" MFL	133.95	138.95	143.95
5	09K06-110	Watts Stainless Steel (Model 9BD)	3/8" MPT	→	3/8" MPT	155.95	161.95	168.95

Additional price breaks available on most items. Login to your website account or contact your sales representative for pricing.

Single and Dual Stage Stainless Steel Check Valves

SEE DESCRIPTIONS BELOW FOR THREAD TYPES



Ref. #	Catalog No.	Description	Inlet	Flow	Outlet	Each
1	09A06-212	Single Check (gas)	1/4" FPT	→	1/4" MPT	7.12
2	09C03-224	Single Check (gas)	3/8" FPT	→	3/8" MPT	7.12
3	09A06-213	Dual Check (water)	1/4" FPT	→	1/4" MPT	10.82
4	09C03-222	Single Check (gas)	1/4" MFL	→	1/4" MFL	7.12
5	09C03-223	Dual Check (water)	3/8" MFL	→	3/8" MFL	10.81

Repair Kits

INCLUDES: O-ring, sleeve, ball, spring, washer

Catalog No.	Description	Each
09C03-215	(Gas) Repair Kit	1.50
09C03-216	(Water) Repair Kit	2.95

Catalog No.	Material	PSI	Thread	25+	10+	Each
09C03-208	S/S	20 PSI	1/4 MPT	5.41	5.73	6.09
09C03-231	S/S	40 PSI	1/4 MPT	5.41	5.73	6.09
09C03-212	S/S	60 PSI	1/4 MPT	5.41	5.73	6.09
09C03-230	Brass	75 PSI	1/4 MPT	4.25	4.50	4.95
09C03-229	S/S	150 PSI	1/8 MPT	5.41	5.73	6.09
09C03-213	S/S	150 PSI	1/4 MPT	5.41	5.73	6.09
09C03-214	S/S	180 PSI	1/4 MPT	CLOSEOUT		6.95
09A06-202	S/S	180 PSI	1/4 FFL	5.41	5.73	6.09

Other pressures and thread types are available



Relief Valves

PSI stamped on body

Strainers

SUCTION-LINE STRAINER

Rubber top with stainless steel, 30 mesh strainer.



IN-LINE STRAINER

White plastic with removable bowl and 80 mesh strainer.

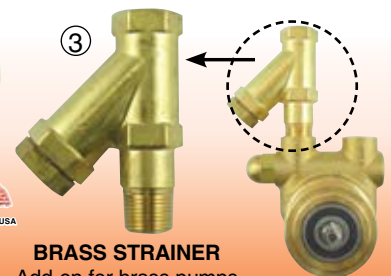

BRASS STRAINER

Add-on for brass pumps currently without a strainer. Uses strainers listed on page 54.

Ref. #	Catalog No.	Description	50+	25+	10+	Each
1	09C03-188	1/4" FPT, 1" diameter	1.50	1.95	2.50	2.95
2	09C03-190	3/8" MPT x 3/8" MPT	4.95	5.25	5.50	5.95
3	09C03-189	3/8" FPT x 3/8" MPT	CLOSEOUT			15.95

Ice Chests with Sealed-In Cold Plate

MEETS HEALTH DEPARTMENT CODES (INCLUDING THOSE PROHIBITING EXPOSED COLD PLATES)

All units can be purchased without a cold plate

- Stainless steel construction
- 1" Foam insulation
- 3/4" barb drain fittings
- Sanitary and attractive



STANDARD SHELF MODEL
18 lb. ice capacity



TALL SHELF MODEL
36 lb. ice capacity

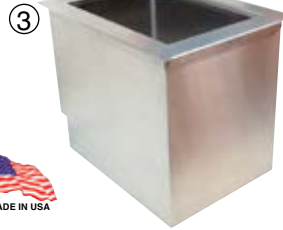

TALL DROP-IN MODEL
36 lb. ice capacity



④ **HINGED LID**



⑤ **INSULATED LID**

Post-Mix • 2 Circuit 15' Length • 1/4" Barb Outlets					
Ref. #	Catalog No.	Height	Width	Depth	Each
1	13D03-133	11-3/4"	12-1/4"	17-1/4"	389.95
2	13D03-149	17-3/4"	12-1/4"	17-1/4"	412.95
3	13D03-150	15-1/4"	12-1/4"	17-1/4"	409.95

Pre-Mix • 6 Circuit 15' Length • 1/2-16 FFL Outlets					
Ref. #	Catalog No.	Height	Width	Depth	Each
1	13D03-132	11-3/4"	12-1/4"	17-1/4"	465.95
2	13D03-145	17-3/4"	12-1/4"	17-1/4"	490.95
3	13D03-190	15-1/4"	12-1/4"	17-1/4"	495.95

Stainless Steel Hinged Lid					
Ref. #	Catalog No.	Fits	Width	Depth	Each
4	13D03-147	All Models	12-1/4"	17-1/4"	75.95

Stainless Steel Insulated Lid					
Ref. #	Catalog No.	Fits	Width	Depth	Each
5	13D03-148	All Models	12-1/4"	17-1/4"	84.95

Ice Chests with Sealed-In Cold Plate

MEETS HEALTH DEPARTMENT CODES (INCLUDING THOSE PROHIBITING EXPOSED COLD PLATES)

- Stainless steel construction
- Foamed in place insulation
- Complete with lid
- Sanitary and attractive



LEG STAND

Fits free-standing model

13D11-300 - 15 x 22 ... **\$61.95**
13D11-301 - 21 x 23 ... **\$65.95**



DROP-IN MODEL



Drop ship only



FREE-STANDING MODEL

3/8" Barb inlets/outlets

DROP-IN ICE CHESTS					
Catalog No.	Size	# of Circuits	Post-mix or Pre-mix	Ice Capacity	Each
13D11-100	15 x 22 x 14-1/4	7	Pre-mix	60 lb.	609.95
13D11-101	15 x 22 x 14-1/4	8	Post-mix	60 lb.	625.95
13D11-102	21 x 23 x 14-1/4	7	Pre-mix	80 lb.	685.95
13D11-103	21 x 23 x 14-1/4	9	Post-mix	80 lb.	715.95

FREE-STANDING ICE CHESTS					
Catalog No.	Size	# of Circuits	Post-mix or Pre-mix	Ice Capacity	Each
13D11-200	15 x 22 x 14-1/4	7	Pre-mix	60 lb.	635.95
13D11-201	15 x 22 x 14-1/4	8	Post-mix	60 lb.	619.95
13D11-202	21 x 23 x 14-1/4	7	Pre-mix	80 lb.	720.95
13D11-203	21 x 23 x 14-1/4	9	Post-mix	80 lb.	699.95

Free-Standing Ice Chest + Leg Stand Combos

13D11-311 (13D11-201 + 13D11-300) **\$645.95** 13D11-310 (13D11-203 + 13D11.301) **\$738.95**

LACROSSE Ice Chest

by PIPER

SPECIFICATIONS

- Constructed of 304 stainless steel
- Insulated ice bin and sliding cover
- Adjustable floor levelers
- 8-circuit sealed-in cold plate
- 30" working height
- 11" ice storage depth
- 19-3/8" from wall to front

CLOSEOUT PRICE
LIMITED STOCK

13C11-124

\$695.00

Ships from Denver, CO



MADE IN USA



WARNING
CANCER AND REPRODUCTIVE HARM.
WWW.P85WARNINGS.CA.GOV

99.7% Pure Aluminum Cold Plates – Solid Aluminum

KEPT COVERED WITH ICE, CHILLS COOL BEVERAGES DOWN TO NEAR FREEZING TEMPERATURES

Cold Plates and Pre-Mix Dispensers

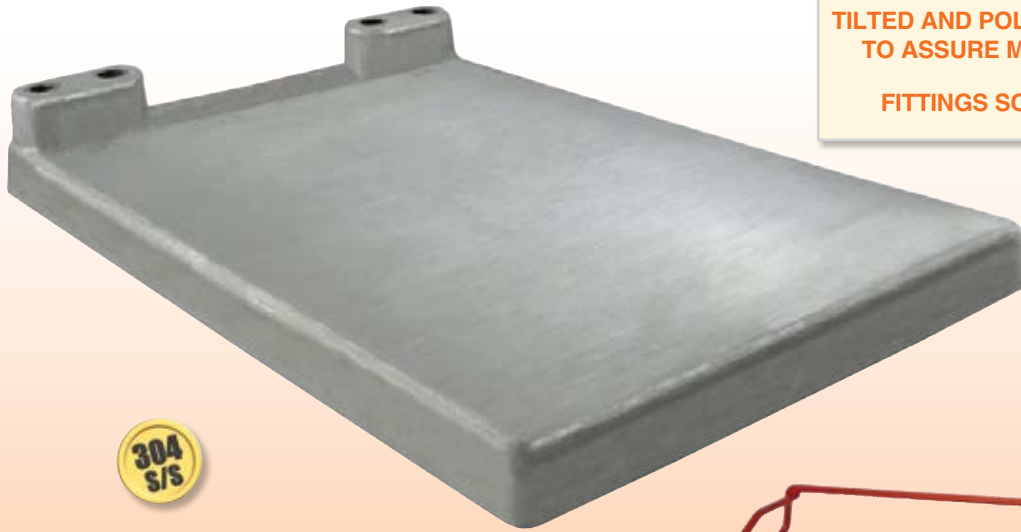

TILTED AND POLISHED TOP SURFACE TO ASSURE MAXIMUM COOLING.

FITTINGS SOLD SEPARATELY



PRODUCT LINES

Cold Plates

Catalog No.	Fits Opening Size	No. of Circuits	Circuit Length	Tube I.D.	3+	Each
13A02-202	8" x 12"	Single	11'	1/4"	59.95	60.95
13A02-203	8" x 12"	Double	11'	1/4"	62.95	63.95
13A02-206	8" x 14"	Three	12'	1/4"	120.95	123.95
13A02-207	8" x 14"	Four	12'	1/4"	131.95	134.95
13A02-208	8" x 14"	Five	12'	1/4"	147.95	151.95
13A02-209	8" x 14"	Six	12'	1/4"	158.95	162.95
13A02-210	8" x 14"	Seven	12'	1/4"	150.95	154.95
13A02-228	8" x 14"	Eight	12'	1/4"	185.95	190.95
13A02-211	10" x 15"	Single	18'	1/4"	82.95	84.95
13A02-212	10" x 15"	Double	18'	1/4"	94.95	97.95
13A02-213	10" x 15"	Three	12'	5/16"	130.95	134.95
13A02-214	10" x 15"	Four	12'	5/16"	151.95	155.95
13A02-215	10" x 15"	Five	18'	1/4"	181.95	186.95
13A02-218	10" x 15"	Six	18'	1/4"	187.95	192.95
13A02-222	12" x 18"	Four	18'	5/16"	248.95	255.95
13A02-224	12" x 18"	Six	18'	5/16"	274.95	281.95
13A02-231	17" x 19"	Six	2 @ 27' 4 @ 12'	5/16"	369.95	379.95



Wire Rack for 10" x 15" cold plates

13K02-100 10+ \$8.95 5+ \$9.50 Ea. \$9.95

Fittings for Cold Plates



Ref.#	Catalog No.	Description	100+	50+	25+	Each
1	04C03-230	1/4" Barb x 1/2-16 MFL	1.30	1.40	1.50	1.75
2	04C03-126	3/8 Barb x 1/2-16 MFL	1.50	1.60	1.70	1.80
3	04C03-233	1/4" MFL x 1/2-16 MFL	1.10	1.20	1.30	1.40

FLARE WASHER PRICES PER 100

Ref.#	Catalog No.	Description	300+	100+	Each
4	04E04-290	Flare Washer 1/2-16	3.99	4.25	8.00

Sanitizing Manifolds with Ball-Lock Connections

SANITIZES LINES, PRODUCT TANKS AND COMPONENTS



20D03-113

5-OUTLET \$64.95



20D03-108

7-OUTLET \$85.95

Wunder-Bar Pre-Mix Dispensers

SETTING THE INDUSTRY STANDARD FOR OVER 40 YEARS



12Q08-183
PICTURED

**RE-DESIGNED BUTTON
WITH REPLACEABLE BUTTON
IDENTIFICATION CAPS**



**DRIP CUP
INCLUDED**

PRE-MIX (FAST FLOW) DISPENSERS					
Catalog No.	No. of Buttons	Hose Connections	6+	3+	Each
12Q08-224	1	1/4" FFL	164.95	168.95	172.95
12Q08-258	2	1/4" FFL	182.95	187.95	191.95

PRE-MIX DISPENSERS (WITH SHIELD)					
Catalog No.	No. of Buttons	Hose Connections	6+	3+	Each
12Q08-186	5	1/4" FFL	205.95	210.95	215.95
12Q08-183	7	1/4" FFL	222.95	227.95	233.95

Replacement Parts

Ref. #	Catalog No.	Description	Each
1	12Q08-285	Ferrule, Tube	0.41
2	12Q08-106	O-ring, Tube Fitting	0.15
3	12Q08-282	Spring, Valve	0.39
4	12Q08-281	Head, Valve	1.89
5	12Q08-133	O-ring, Valve	0.24
6	12Q08-279	Tail, Valve	1.89
7	12Q08-131	O-ring, Valve Ext.	0.50
8	12Q08-199	Button, (for I.D. Caps)	1.70
9	12Q08-353	Drip Cup Assembly	11.00
10	-	I.D. Caps (see pg. 30)	-



Additional price breaks available on most items. Login to your website account or contact your sales representative for pricing.

Pre-Mix Squeeze Valve

This widely used Pre-Mix Dispensing Valve features positive flow control, preventing carbonation loss. The slotted adjustment screw can be easily set to deliver product at varying flow rates. This valve was designed to dispense bottle quality pre-mixed product.



11F09-141
MOUNTING BRACKET

6+ **\$3.95** 3+ \$4.25 Ea. \$4.50



12C07-141
1/4" MFL CONNECTION

6+ **\$63.95** 3+ \$65.95 Ea. \$68.95



12C07-140
1/4" BARB CONNECTION

6+ **\$41.95** 3+ \$43.95 Ea. \$45.95

Pre-Mix Dispensing Valves



12C07-144

1/4" MFL



6+ \$58.95 3+ \$61.95 Ea. \$63.95



CMBecker
INTERNATIONAL, LLC

12C07-143

1/4" MFL

6+ \$41.95 3+ \$42.95 Ea. \$44.95

Additional price breaks available on most items. Login to your website account or contact your sales representative for pricing.

Replacement Parts for Pre-Mix Valve

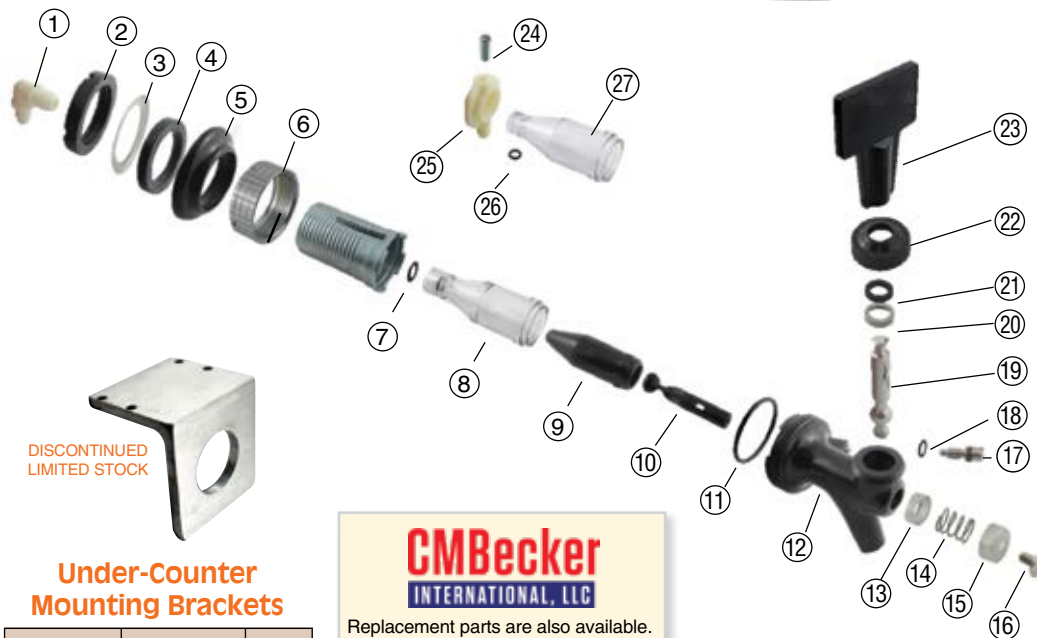

Flavor Labels for Pre-Mix valves

DISCONTINUED LIMITED STOCK



Description	25+	10+	Each
Regular	0.63	0.68	0.75
*Coke Products	2.71	2.88	3.03

Catalog No.	Description
12C07-359	7-Up
12C07-345	Cola
12C07-349	Dr. Pepper
12C07-348	Diet Dr. Pepper
12C07-350	Ginger Ale
12C07-372	Ice Water
12C07-325	Mountain Dew
12C07-354	Orange
12C07-355	Pepsi
12C07-324	Diet Pepsi
12C07-358	RC
12C07-357	Root Beer
12C07-360	Soda
12C07-363	DISC.
12C07-342	DISC.
12C07-346	*Diet Coke
12C07-352	*Mello Yello
12C07-353	*Mr. Pibb
12C07-361	*Sprite

Under-Counter Mounting Brackets

Catalog No.	No. of holes	Each
12C03-111	One	9.95

CMBecker
INTERNATIONAL, LLC

Replacement parts are also available. Contact your sales representative for pricing and availability.

Ref. #	Catalog No.	Description	Each
1	12C07-200	Elbow, 1/4MFL x 1/2-16 MFL	1.06
2	12C07-187	Nut, Shank	DISC.
3	12C07-188	Washer, Shank Seal	3.09
4	12C07-189	Seal, Shank (rubber)	DISC.
5	12C07-190	Flange, (2" diameter)	DISC.
5	12C07-191	Flange, (2-1/2" diameter)	10.52
6	12C07-202	Nut, Coupling (chrome)	DISC.
7	12C07-204	O-ring (long shank)	0.15
8	12C07-205	Shank (long)	10.35
9	12C07-206	Compensator (black)	9.82
10	12C07-213	Plunger/Seat Assembly	29.34
11	12C07-211	O-ring, Faucet	0.18
12	12C07-218	Body, Pre-mix valve	25.41
13	12C07-214	Sleeve, Spring (inner)	1.59

Ref. #	Catalog No.	Description	Each
14	12C07-215	Spring, Self-closing	0.57
15	12C07-216	Sleeve, Spring (outer)	1.17
16	12C07-217	Screw, Phillips Head	0.33
17	12C07-219	Adjustable Screw, Compensator	3.97
18	12C07-220	O-ring, Comp. screw	0.15
19	12C07-222	Lever, Pre-Mix Knob	DISC.
20	12C07-223	Washer, Ball	0.29
21	12C07-224	Washer, Friction	0.23
22	12C07-225	Bonnet, Pre-mix Faucet	1.85
23	12C07-129	Knob, T-handle	5.61
24	12C07-195	Screw, Yoke	1.82
25	12C07-196	Yoke	7.42
26	12C07-199	O-ring (short shank)	0.10
27	12C07-198	Shank (short)	9.02

Universal Gauge Protector

REGULATOR NOT INCLUDED



03A09-100 24+ **\$6.95**



12+ \$7.50

6+ \$7.95



Each \$8.95

Rubber Gauge Boot

Offers moderate protection of 2" diameter gauges

Made of flexible PVC

03S07-100



50+ **\$1.66** 25+ \$1.77
10+ \$1.88 5+ \$2.00 Ea. \$2.09

Universal Gauge Cage

Designed to fit most regulators with 2" diameter gauges

Made of chrome plated steel

03E01-101



24+ **\$12.95** 12+ \$13.95
6+ \$14.95 Ea. \$15.95

Dry and Liquid Filled Gauges

Catalog No.	Range	Threaded	50+	25+	10+	5+	Each
03G07-153	0-15 lb	Right Hand	3.00	3.25	3.50	3.75	4.00
03G07-154	0-30 lb	Right Hand	3.00	3.25	3.50	3.75	4.00
03G07-155	0-60 lb	Right Hand	3.00	3.25	3.50	3.75	4.00
03C03-127	0-100 lb	Right Hand	3.00	3.25	3.50	3.75	4.00

Catalog No.	Range	Threaded	50+	25+	10+	5+	Each
03G07-141	0-15 lb	Right Hand	3.00	3.25	3.50	3.75	4.00
03G07-140	0-30 lb	Right Hand	3.00	3.25	3.50	3.75	4.00
03G07-142	0-60 lb	Right Hand	3.00	3.25	3.50	3.75	4.00
03G07-143	0-100 lb	Right Hand	3.00	3.25	3.50	3.75	4.00
03G07-144	0-160 lb	Right Hand	3.00	3.25	3.50	3.75	4.00
03G07-145	0-300 lb	Right Hand	3.00	3.25	3.50	3.75	4.00

Catalog No.	Range	Threaded	50+	25+	10+	5+	Each
03G07-219	0-2000 lb.	Right Hand	3.50	3.75	4.00	4.25	4.50
03G07-146	0-3000 lb.	Right Hand	3.50	3.75	4.00	4.25	4.50
03G07-283	0-2000 lb.	Left Hand	3.50	3.75	4.00	4.25	4.50
03G07-285	0-3000 lb.	Left Hand	3.50	3.75	4.00	4.25	4.50

Catalog No.	Range	Threaded	50+	25+	10+	5+	Each
03G07-400	0-15 lb	Right Hand	8.95	9.50	9.95	10.50	10.95
03G07-401	0-30 lb	Right Hand	8.95	9.50	9.95	10.50	10.95
03G07-402	0-60 lb	Right Hand	8.95	9.50	9.95	10.50	10.95
03G07-403	0-100 lb	Right Hand	8.95	9.50	9.95	10.50	10.95
03G07-404	0-160 lb	Right Hand	8.95	9.50	9.95	10.50	10.95

1-1/2" Diameter Low Pressure

Dry Gauges – 1/8" MPT Stem

- Steel case
- Phosphor bronze bourdon tube
- Dual scale PSI & BAR
- Accuracy ± 1.6%



2" Diameter Low Pressure

Dry Gauges – 1/4" MPT Stem

- Steel case
- Phosphor bronze bourdon tube
- Dual scale PSI & BAR
- Accuracy ± 1.6%



2" Diameter High Pressure

Dry Gauges – 1/4" MPT Stem

- Steel case
- Phosphor bronze bourdon tube
- Dual scale PSI & BAR
- Accuracy ± 1.6%



2-1/2" Diameter Low Pressure

Glycerine Filled Gauges – 1/4" MPT Stem

- Stainless steel case and bezel
- Phosphor bronze bourdon tube
- Dual scale PSI & BAR
- Accuracy ± 1.6%



Gauge Protectors, Gauges and Manifolds



Secondary
TruRegs™

0-15 PSI Secondary TruRegs™

HIGHER FLOW RATES • HIGHER PERFORMANCE • GREATER ACCURACY • GREATER SENSITIVITY
DEPENDABLE AND RELIABLE • EXCEPTIONALLY LOW PRESSURE LOSS IN SERIES • EASY SERVICE



Catalog No.	Number of Regs.	Description	24+	12+	6+	Each
03M03-101	1	0-15 PSI, 1/4" MFL In/Out, 3/8" Barb Shutoff	66.95	69.95	71.95	74.95
03M03-102	2	0-15 PSI, 1/4" MFL In/Out, 3/8" Barb Shutoff	116.95	121.95	124.95	129.95
03M03-103	3	0-15 PSI, 1/4" MFL In/Out, 3/8" Barb Shutoff	167.95	173.95	178.95	186.95
03M03-104	4	0-15 PSI, 1/4" MFL In/Out, 3/8" Barb Shutoff	217.95	226.95	232.95	242.95

Have a balanced draught system
and still having **POURING PROBLEMS?**
We designed a solution.



Secondary
TruRegs™

0-60 PSI Secondary TruRegs™



Catalog No.	Number of Regs.	Description	24+	12+	6+	Each
03M03-111	1	0-60 PSI, 1/4" MFL In/Out, 3/8" Barb Shutoff	66.95	69.95	71.95	74.95
03M03-112	2	0-60 PSI, 1/4" MFL In/Out, 3/8" Barb Shutoff	116.95	121.95	124.95	129.95
03M03-113	3	0-60 PSI, 1/4" MFL In/Out, 3/8" Barb Shutoff	167.95	173.95	178.95	186.95
03M03-114	4	0-60 PSI, 1/4" MFL In/Out, 3/8" Barb Shutoff	217.95	226.95	232.95	242.95



TAPRITE Primary CO₂ Soda Regulators

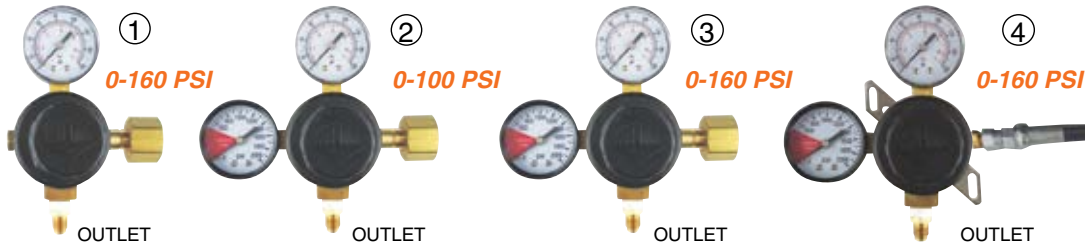

**NOW WITH
LONGER CO₂ STEMS**

**WALL MOUNT
REGULATOR
WITH
SIX FOOT
HIGH PRESSURE
HOSE**

Taprite Soda Regulators

ALL OUTLETS

HAVE A CHECK VALVE

SELECT FROM AVAILABLE OUTLETS

(A)

1/4" MFL

(B)

1/4" MFL

(C)

1/4" BARB

(D)

3/8" BARB

Ref. #	Catalog No.	Gauge	24+	12+	6+	Each
1A	03J06-102	160 lb.	38.95	39.95	40.95	42.95
1B	03J06-109	160 lb.	40.95	42.95	43.95	45.95
1C	03J06-110	160 lb.	41.95	42.95	44.95	46.95
1D	03J06-111	160 lb.	41.95	42.95	44.95	46.95
2A	03J06-104	100 lb.	37.95	38.95	40.95	42.95
2B	03J06-112	100 lb.	40.95	41.95	43.95	45.95
2C	03J06-113	100 lb.	40.95	41.95	43.95	45.95
2D	03J06-114	100 lb.	40.95	41.95	43.95	45.95

Outlet (w/Check Valve)
1/4" MFL
1/4" MFL Shutoff
1/4" Barb Shutoff
3/8" Barb Shutoff
1/4" MFL
1/4" MFL Shutoff
1/4" Barb Shutoff
3/8" Barb Shutoff

Ref. #	Catalog No.	Gauge	24+	12+	6+	Each
3A	03J06-103	160 lb.	39.95	40.95	42.95	44.95
3B	03J06-115	160 lb.	42.95	43.95	45.95	47.95
3C	03J06-116	160 lb.	43.95	44.95	46.95	48.95
3D	03J06-117	160 lb.	43.95	44.95	46.95	48.95
4A	03C09-103	160 lb.	65.95	66.95	69.95	72.95
4B	03J06-118	160 lb.	68.95	69.95	72.95	76.95
4C	03J06-119	160 lb.	68.95	70.95	73.95	76.95
4D	03J06-120	160 lb.	68.95	70.95	73.95	76.95

Additional price breaks available on most items. Login to your website account or contact your sales representative for pricing.

TAPRITE Secondary & Nitrogen Soda Regulators

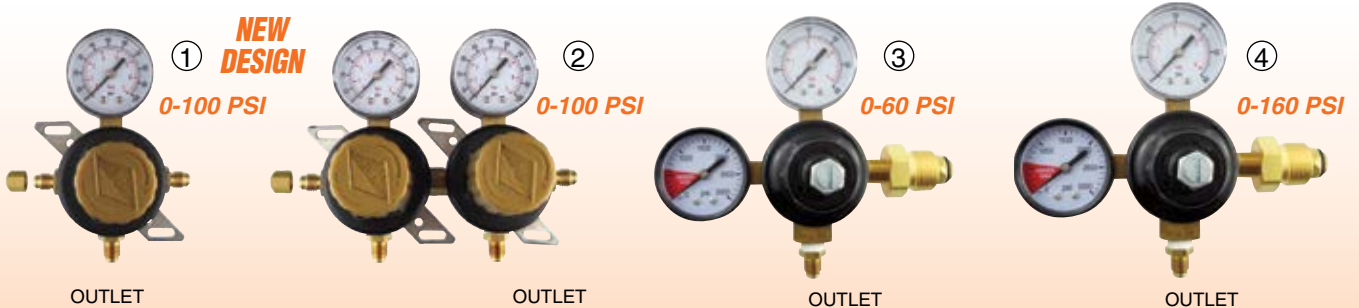

SECONDARY REGULATORS ARE NOW UNIVERSAL AND CAN BE USED AS A PASSTHRU AS WELL

Ref. #	Catalog No.	Gauge	24+	12+	6+	Each
1A	03J06-105	100 lb.	35.95	36.95	37.95	39.95
1B	03J06-121	100 lb.	38.95	39.95	41.95	42.95
1C	03J06-122	100 lb.	38.95	39.95	41.95	43.95
1D	03J06-123	100 lb.	38.95	39.95	41.95	43.95
2A	03D03-117	100 lb.	71.95	74.95	76.95	80.95
2B	03J06-124	100 lb.	74.95	77.95	79.95	82.95
2C	03J06-125	100 lb.	73.95	76.95	78.95	82.95
2D	03J06-126	100 lb.	73.95	76.95	78.95	82.95

Outlet (w/Check Valve)
1/4" MFL
1/4" MFL Shutoff
1/4" Barb Shutoff
3/8" Barb Shutoff
1/4" MFL
1/4" MFL Shutoff
1/4" Barb Shutoff
3/8" Barb Shutoff

Ref. #	Catalog No.	Gauge	24+	12+	6+	Each
3A	03D03-114	60 lb.	43.95	44.95	46.95	48.95
3B	03J06-127	60 lb.	46.95	47.95	49.95	52.95
3C	03J06-128	60 lb.	46.95	48.95	50.95	52.95
3D	03C09-115	60 lb.	46.95	47.95	50.95	51.95
4A	03C09-119	160 lb.	42.95	43.95	45.95	47.95
4B	03J06-130	160 lb.	45.95	47.95	49.95	51.95
4C	03J06-131	160 lb.	46.95	47.95	49.95	51.95
4D	03C09-114	160 lb.	46.95	47.95	49.95	51.95



Primary CO₂ Soda Regulators



**NOW WITH
LONGER CO₂ STEMS**

WALL MOUNT
REGULATOR
WITH
SIX FOOT
HIGH PRESSURE
HOSE

Cornelius Soda Regulators

**ALL
OUTLETS**

**HAVE A
CHECK
VALVE**

SELECT FROM AVAILABLE OUTLETS

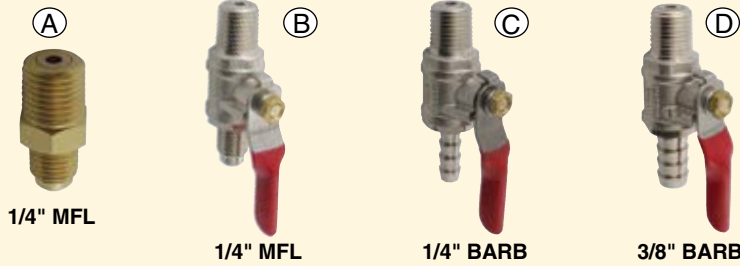

Ref. #	Catalog No.	Gauge	24+	12+	6+	Each
1A	03D03-181	160 lb.	35.95	36.95	38.95	40.95
1B	03D03-182	160 lb.	38.95	39.95	41.95	43.95
1C	03D03-183	160 lb.	39.95	40.95	41.95	43.95
1D	03D03-184	160 lb.	39.95	40.95	42.95	43.95
2A	03D03-170	100 lb.	40.95	42.95	43.95	45.95
2B	03D03-176	100 lb.	43.95	45.95	46.95	49.95
2C	03D03-177	100 lb.	44.95	45.95	47.95	49.95
2D	03D03-276	100 lb.	44.95	45.95	47.95	49.95

Outlet (w/Check Valve)	
1/4" MFL	
1/4" MFL Shutoff	
1/4" Barb Shutoff	
3/8" Barb Shutoff	
1/4" MFL	
1/4" MFL Shutoff	
1/4" Barb Shutoff	
3/8" Barb Shutoff	

Ref. #	Catalog No.	Gauge	24+	12+	6+	Each
3A	03D03-180	160 lb.	37.95	38.95	40.95	42.95
3B	03D03-185	160 lb.	40.95	41.95	43.95	45.95
3C	03D03-186	160 lb.	40.95	42.95	43.95	45.95
3D	03D03-187	160 lb.	41.95	42.95	43.95	45.95
4A	03D03-102	160 lb.	63.95	65.95	68.95	71.95
4B	03D03-190	160 lb.	66.95	68.95	71.95	74.95
4C	03D03-191	160 lb.	66.95	68.95	71.95	74.95
4D	03D03-192	160 lb.	66.95	68.95	71.95	74.95

Additional price breaks available on most items. Login to your website account or contact your sales representative for pricing.



Secondary & Nitrogen Soda Regulators

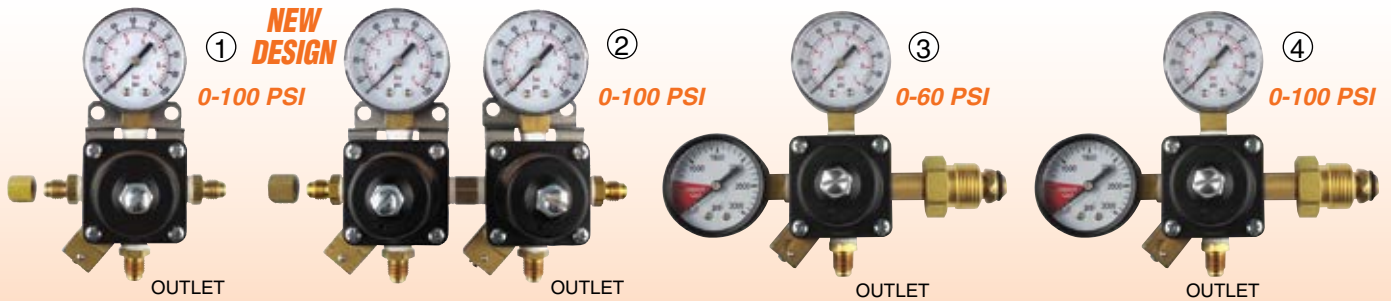

SECONDARY REGULATORS ARE NOW UNIVERSAL AND CAN BE USED AS A PASSTHRU AS WELL

Ref. #	Catalog No.	Gauge	24+	12+	6+	Each
1A	03D03-127	100 lb.	43.95	44.95	46.95	48.95
1B	03D03-216	100 lb.	46.95	47.95	49.95	52.95
1C	03D03-217	100 lb.	46.95	48.95	50.95	52.95
1D	03D03-218	100 lb.	46.95	48.95	50.95	52.95
2A	03D03-110	100 lb.	86.95	89.95	92.95	96.95
2B	03D03-219	100 lb.	88.95	91.95	94.95	98.95
2C	03D03-220	100 lb.	88.95	92.95	95.95	99.95
2D	03D03-221	100 lb.	89.95	92.95	95.95	99.95

Outlet (w/Check Valve)	
1/4" MFL	
1/4" MFL Shutoff	
1/4" Barb Shutoff	
3/8" Barb Shutoff	
1/4" MFL	
1/4" MFL Shutoff	
1/4" Barb Shutoff	
3/8" Barb Shutoff	

Ref. #	Catalog No.	Gauge	24+	12+	6+	Each
3A	03D03-168	60 lb.	39.95	41.95	42.95	44.95
3B	03D03-222	60 lb.	42.95	44.95	45.95	47.95
3C	03D03-223	60 lb.	43.95	44.95	46.95	48.95
3D	03D03-169	60 lb.	43.95	44.95	46.95	48.95
4A	03D03-266	100 lb.	41.95	43.95	44.95	46.95
4B	03D03-225	100 lb.	44.95	46.95	48.95	50.95
4C	03D03-226	100 lb.	45.95	46.95	48.95	50.95
4D	03D03-267	100 lb.	45.95	46.95	48.95	50.95



TAPRITE Economy Primary CO₂ Soda Regulator

The Economy Series Primary Soft Drink Regulator is easy to use and to maintain. The set screw adjustment makes it a "set and forget" tool for maintaining constant pressure into your system. The regulator's zinc bonnet and brass body and fittings help to minimize the chance for freeze-ups during peak usage while also making it corrosion resistant and highly durable in a number of environments.

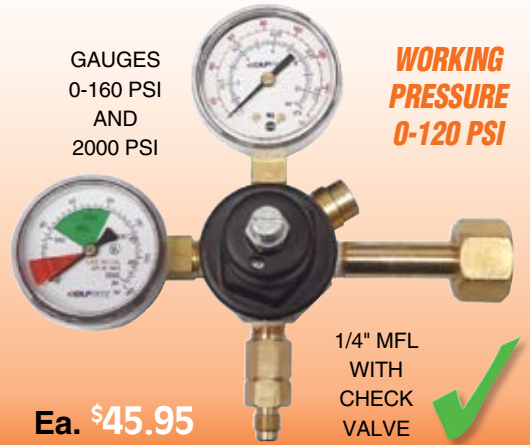

03C09-302 24+ **\$40.95** 12+ \$41.95 6+ \$43.95 Ea. \$45.95

Universal Gauge Protectors



03E01-101
24+ **\$12.95** 12+ \$13.95
6+ \$14.95 Ea. \$15.95

FITS ALL THREE BRANDS SHOWN AND SOME OTHERS AS WELL

03A09-100
24+ **\$6.95** 12+ \$7.50 6+ \$7.95 Ea. \$8.95

Regulator Internal Repair Kits



Ref. #	Catalog No.	Description	24+	12+	6+	Each
1	03D03-140	Economy Kit (round)	4.70	4.95	5.50	5.95
2	03D03-303	Economy Kit (hex)	5.85	6.10	6.45	6.80
3	03C09-112	Taprite Kit (all models)	11.13	11.62	12.34	12.95

Ref. #	Catalog No.	Description	24+	12+	6+	Each
3a	06C09-101	Taprite (inlet washer)	0.35	0.37	0.39	0.47
4	03C07-113	Cornelius (secondary)	11.21	11.83	12.53	13.31
5	03C07-216	Cornelius (primary)	10.35	10.92	11.39	12.29

Taprite Regulator, Gauge Protectors and Repair Kits

FROST BUSTER

TWO-INTO-ONE HIGH-FLOW REGULATORS

HELPS PREVENT REGULATORS FROM FREEZING UP WHEN HIGH VOLUMES OF CO₂ ARE BEING USED. SPLITS CO₂ FLOW INTO TWO REGULATORS THEN BACK INTO ONE GAS LINE OUT.



All regulators listed have shutoffs with 3/8" barb and a back check valve

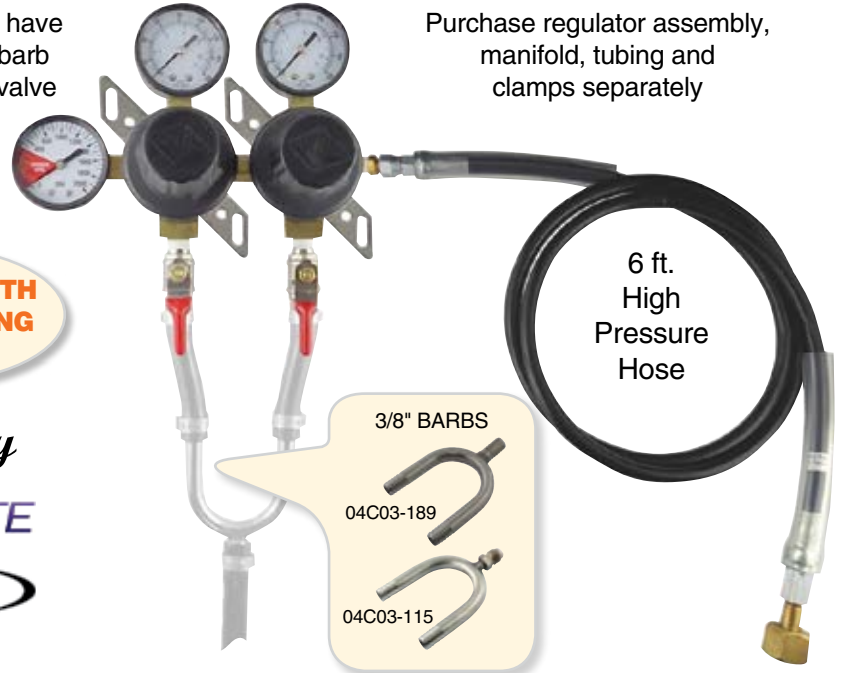

Purchase regulator assembly, manifold, tubing and clamps separately

6 ft. High Pressure Hose

AVAILABLE WITH THE FOLLOWING BODIES



NOW WITH LONGER CO₂ STEMS

TANK MOUNT WITH CO ₂ NUT/STEM						
Cat. No	Brand	Gauges	24+	12+	6+	Each
03D03-107	Economy	300 lb. & 2000 lb.	TEMPORARILY UNAVAILABLE			
03C09-106	Taprite	160 lb. & 2000 lb.	83.95	86.95	89.95	93.95
03D03-171	Cornelius	160 lb. & 2000 lb.	79.95	82.95	84.95	88.95

WALL MOUNT WITH 6' HIGH PRESSURE HOSE						
Cat. No	Brand	Gauges	24+	12+	6+	Each
03D03-112	Economy	300 lb. & 2000 lb.	TEMPORARILY UNAVAILABLE			
03C09-120	Taprite	160 lb. & 2000 lb.	106.95	110.95	113.95	118.95
03D03-175	Cornelius	160 lb. & 2000 lb.	103.95	107.95	110.95	115.95

Additional price breaks available on most items. Login to your website account or contact your sales representative for pricing.

Miniature (Multi-Product) Regulators



- 100 psi gauge
- Brass body
- Back-check valve
- Compact size
- 1/4" MFL fittings
- Quality construction



- 60 psi gauge
- Brass body
- Back-check valve
- Compact size
- 1/4" MFL fittings
- Quality construction
- 4/5 products have a inlet tee

DISCONTINUED - LIMITED STOCK

Cat. No	Description	24+	12+	6+	Each
03C03-100	1 product, 100 lb. Gauge	23.95	24.95	25.95	26.95
03C03-101	4 products, 100 lb. Gauge	28.95	29.95	30.95	31.95
03C03-102	5 products, 100 lb. Gauge	30.95	31.95	32.95	33.95

Cat. No	Description	24+	12+	6+	Each
03G07-131	1 product, 15 lb. Gauge	42.95	43.95	45.95	47.95
03G07-503	1 product, 60 lb. Gauge	42.95	43.95	45.95	47.95
03G07-129	2 products, 60 lb. Gauge	44.95	45.95	47.95	49.95
03G07-130	4 products, 60 lb. Gauge	49.95	51.95	53.95	55.95

Air Distributors – Extruded Aluminum Body



CAP & WASHER



QUICKLY & EASILY CONVERT FROM RIGHT HAND INLET TO LEFT HAND INLET OR PASSTHRU

Catalog No.	Outlets	48+	24+	12+	6+	Each
03C03-400	2	7.50	7.95	8.50	8.95	9.50
03C03-401	3	10.50	10.95	11.50	11.95	12.50
03C03-402	4	11.95	12.50	12.95	13.50	13.95
03C03-403	5	15.50	16.50	16.95	17.95	18.95
03C03-404	6	19.95	20.50	20.95	21.95	22.95
03C03-405	7	22.95	23.95	24.50	24.95	25.95
03C03-406	8	23.95	24.95	25.50	25.95	26.95
03C03-407	9	23.95	24.95	25.95	26.95	27.95

1/4" MFL (INLET) + CAP/WASHER



1/4" MFL (OUTLETS)



Catalog No.	Outlets	48+	24+	12+	6+	Each
03C03-408	2	7.95	8.50	8.95	9.50	9.95
03C03-409	3	11.50	11.95	12.50	12.95	13.95
03C03-410	4	13.50	14.50	14.95	15.50	16.50
03C03-411	5	17.50	18.50	18.95	19.95	20.95
03C03-412	6	20.95	22.95	23.50	23.95	24.95
03C03-413	7	24.95	25.95	26.95	27.95	29.95
03C03-414	8	26.95	27.95	28.95	29.95	31.95
03C03-415	9	26.95	27.95	28.95	29.95	30.95

1/4" MFL (INLET) + CAP/WASHER



1/4" MFL (OUTLETS)



Catalog No.	Outlets	48+	24+	12+	6+	Each
03C03-416	2	15.95	16.50	17.50	17.95	18.95
03C03-417	3	22.95	23.95	24.95	25.95	27.95
03C03-418	4	28.95	29.95	31.95	32.95	34.95
03C03-419	5	35.95	37.95	39.95	40.95	43.95
03C03-420	6	42.95	44.95	46.95	48.95	52.95
03C03-421	7	49.95	52.95	54.95	56.95	60.95
03C03-422	8	54.95	57.95	59.95	62.95	66.95
03C03-423	9	57.95	60.95	63.95	66.95	70.95

1/4" BARB (INLET) + CAP/WASHER



1/4" BARB SHUTOFF (OUTLETS)



Catalog No.	Outlets	48+	24+	12+	6+	Each
03C03-424	2	14.95	15.95	16.50	16.95	17.95
03C03-425	3	21.95	22.95	23.95	24.95	25.95
03C03-426	4	26.95	27.95	28.95	30.95	32.95
03C03-427	5	32.95	34.95	36.95	37.95	40.95
03C03-428	6	40.95	41.95	43.95	45.95	47.95
03C03-429	7	46.95	48.95	50.95	52.95	55.95
03C03-430	8	50.95	53.95	54.95	57.95	60.95
03C03-431	9	53.95	55.95	57.95	60.95	63.95

3/8" BARB (INLET) + CAP/WASHER



3/8" BARB SHUTOFF (OUTLETS)



Catalog No.	Outlets	48+	24+	12+	6+	Each
03C03-432	2	16.50	17.50	17.95	18.95	19.95
03C03-433	3	23.95	24.95	25.95	26.95	28.95
03C03-434	4	29.95	30.95	32.95	33.95	35.95
03C03-435	5	36.95	38.95	39.95	41.95	44.95
03C03-436	6	43.95	45.95	47.95	49.95	53.95
03C03-437	7	50.95	53.95	55.95	57.95	61.95
03C03-438	8	55.95	58.95	60.95	63.95	67.95
03C03-439	9	58.95	62.95	64.95	67.95	71.95

3/8" BARB (INLET) + CAP/WASHER



3/8" BARB SHUTOFF (OUTLETS)



Catalog No.	Outlets	48+	24+	12+	6+	Each
03C03-440	2	14.50	15.50	15.95	16.50	17.50
03C03-441	3	20.95	21.95	22.95	23.95	25.95
03C03-442	4	26.95	27.95	29.95	30.95	32.95
03C03-443	5	34.95	35.95	36.95	38.95	40.95
03C03-444	6	41.95	42.95	44.95	46.95	49.95
03C03-445	7	48.95	50.95	51.95	53.95	57.95
03C03-446	8	52.95	54.95	56.95	58.95	62.95
03C03-447	9	56.95	58.95	60.95	62.95	66.95

1/4" MFL (INLET) + CAP/WASHER



1/4" MFL SHUTOFF (OUTLETS)



Catalog No.	Outlets	48+	24+	12+	6+	Each
03C03-448	2	14.50	14.95	15.50	16.50	17.50
03C03-449	3	20.95	21.95	22.95	23.95	25.95
03C03-450	4	26.95	27.95	28.95	29.95	31.95
03C03-451	5	33.95	35.95	36.95	37.95	40.95
03C03-452	6	40.95	42.95	43.95	45.95	48.95
03C03-453	7	47.95	49.95	50.95	53.95	56.95
03C03-454	8	51.95	54.95	55.95	58.95	61.95
03C03-455	9	55.95	57.95	59.95	61.95	65.95

1/4" MFL (INLET) + CAP/WASHER



1/4" MFL SHUTOFF (OUTLETS)



Air Distributors – Chrome Plated Brass Body



See page 54 for relief valves



QUICKLY & EASILY CONVERT FROM RIGHT HAND INLET TO LEFT HAND INLET OR PASSTHRU

1/4" MFL (OUTLETS)

1/4" MFL (INLET) + CAP/WASHER

Catalog No.	Outlets	48+	24+	12+	6+	Each
03B03-400	2	7.95	8.50	8.95	9.50	9.95
03B03-401	3	11.50	11.95	12.50	12.95	13.95
03B03-402	4	14.50	14.95	15.50	15.95	16.95
03B03-403	5	17.95	18.95	19.95	20.95	21.95
03B03-404	6	20.95	21.95	22.95	23.95	24.95
03B03-405	7	23.95	24.95	25.95	26.95	28.95
03B03-406	8	26.95	27.95	28.95	29.95	31.95



1/4" MFL (OUTLETS)

1/4" MFL (INLET) + CAP/WASHER

Catalog No.	Outlets	48+	24+	12+	6+	Each
03B03-407	2	8.95	9.50	9.95	10.50	10.95
03B03-408	3	12.50	12.95	13.50	13.95	14.95
03B03-409	4	15.95	16.50	16.95	17.95	18.95
03B03-410	5	19.95	20.95	21.95	22.95	23.95
03B03-411	6	22.95	23.95	24.95	26.95	27.95
03B03-412	7	26.95	27.95	28.95	29.95	31.95
03B03-413	8	29.95	30.95	31.95	33.95	35.95



1/4" BARB SHUTOFF (OUTLETS)

1/4" BARB (INLET) + CAP/WASHER

Catalog No.	Outlets	48+	24+	12+	6+	Each
03B03-245	2	16.50	16.95	17.95	18.50	18.95
03B03-246	3	23.95	24.95	25.95	26.95	27.95
03B03-247	4	30.95	31.95	32.95	34.95	35.95
03B03-417	5	37.95	39.95	40.95	42.95	43.95
03B03-418	6	44.95	46.95	48.95	50.95	52.95
03B03-419	7	51.95	53.95	55.95	58.95	60.95
03B03-420	8	58.95	60.95	63.95	65.95	68.95



3/8" BARB SHUTOFF (OUTLETS)

3/8" BARB (INLET) + CAP/WASHER

Catalog No.	Outlets	48+	24+	12+	6+	Each
03B03-127	2	15.95	16.50	16.95	17.95	18.95
03B03-129	3	21.95	23.95	24.95	25.95	26.95
03B03-130	4	28.95	29.95	30.95	31.95	33.95
03B03-424	5	34.95	36.95	37.95	39.95	40.95
03B03-425	6	41.95	43.95	44.95	46.95	48.95
03B03-426	7	47.95	49.95	51.95	53.95	56.95
03B03-427	8	53.95	55.95	57.95	60.95	62.95



3/8" BARB SHUTOFF (OUTLETS)

3/8" BARB (INLET) + CAP/WASHER

Catalog No.	Outlets	48+	24+	12+	6+	Each
03B03-242	2	16.95	17.95	18.50	18.95	19.95
03B03-243	3	24.95	25.95	26.95	27.95	28.95
03B03-244	4	31.95	32.95	33.95	35.95	36.95
03B03-431	5	38.95	39.95	41.95	43.95	45.95
03B03-432	6	45.95	47.95	49.95	51.95	53.95
03B03-433	7	52.95	54.95	56.95	59.95	61.95
03B03-434	8	59.95	61.95	64.95	66.95	69.95



1/4" MFL SHUTOFF (OUTLETS)

1/4" MFL (INLET) + CAP/WASHER

Catalog No.	Outlets	48+	24+	12+	6+	Each
03B03-435	2	15.50	15.95	16.50	16.95	17.95
03B03-436	3	21.95	22.95	23.95	24.95	25.95
03B03-437	4	28.95	29.95	30.95	32.95	33.95
03B03-438	5	35.95	36.95	38.95	39.95	41.95
03B03-439	6	42.95	44.95	45.95	47.95	49.95
03B03-440	7	48.95	50.95	52.95	55.95	57.95
03B03-441	8	55.95	57.95	59.95	62.95	64.95



1/4" MFL SHUTOFF (OUTLETS)

1/4" MFL (INLET) + CAP/WASHER

Catalog No.	Outlets	48+	24+	12+	6+	Each
03B03-442	2	14.95	15.50	16.50	16.95	17.95
03B03-443	3	21.95	22.95	23.95	24.95	25.95
03B03-444	4	28.95	29.95	30.95	31.95	33.95
03B03-445	5	34.95	36.95	37.95	39.95	41.95
03B03-446	6	41.95	43.95	45.95	47.95	49.95
03B03-447	7	48.95	49.95	52.95	54.95	56.95
03B03-448	8	54.95	56.95	58.95	61.95	64.95



Air Distributors - Chrome Plated Brass Body



Regulator and Air Distributor Fittings

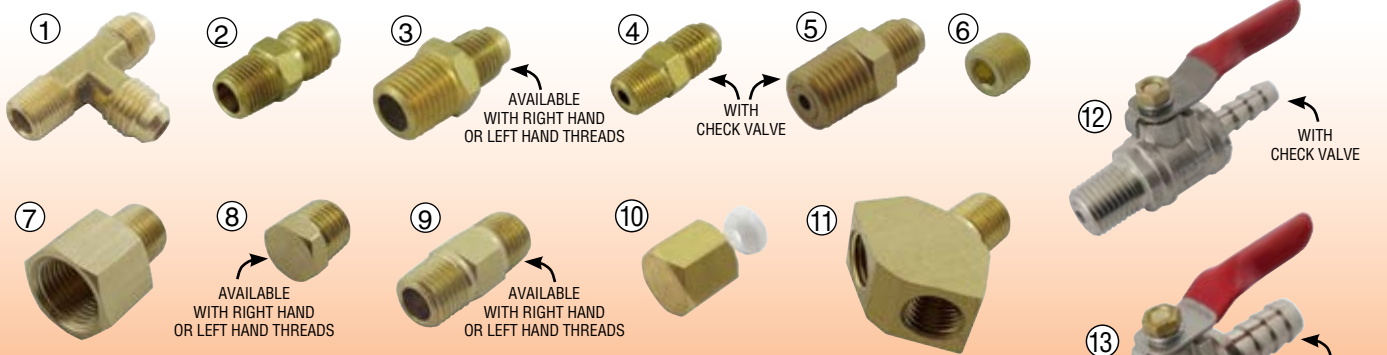

Ref. #	Catalog No.	Description	100+	50+	25+	Each
1	05B01-206	Tee, 1/8" MPT x 1/4" MFL x 1/4" MFL	1.96	2.08	2.18	2.38
2	05B01-228	Adapter, 1/4" MFL x 1/8" MPT	0.33	0.35	0.37	0.39
3a	05B01-183	Adapter, 1/4" MFL x 1/4" MPT (RH Thread)	0.55	0.60	0.65	0.70
3b	03C03-122	Adapter, 1/4" MFL x 1/4" MPT (LH Thread)	1.37	1.44	1.53	1.62
4	03G07-174	Check Valve, 1/8" MPT > 1/4" MFL	2.25	2.35	2.45	2.75
5	05B01-345	Check Valve, 1/4" MPT > 1/4" MFL	0.90	0.95	1.00	1.50
6a	05B01-134	Pipe Plug, 1/8" MPT	0.32	0.34	0.36	0.39
6b	05B01-135	Pipe Plug, 1/4" MPT	0.42	0.45	0.47	0.51
7a	05B01-162	Reducer, 1/4" FPT x 1/8" MPT	0.55	0.58	0.61	0.66
7b	05B01-166	Reducer, 3/8" FPT x 1/4" MPT	1.05	1.10	1.15	1.25
8a	05B01-154	Hex Plug, 1/4" MPT (RH Thread)	0.42	0.44	0.46	0.50
8b	03S07-101	Hex Plug, 1/4" MPT (LH Thread)	0.94	1.00	1.05	1.14
9a	03G07-241	Hex Nipple, 1/4" MPT x 1/4" MPT (RH Thread)	0.95	1.00	1.05	1.25
9b	03C07-245	Hex Nipple, 1/4" MPT x 1/4" MPT (LH Thread)	1.90	2.01	2.13	2.24
9c	05C03-101	Hex Nipple, 1/4" MPT x 1/4" MPT (LHT x RHT)	2.44	2.58	2.74	2.87
10	03G07-237	Cap and Flare Washer, 1/4" FFL	0.37	0.39	0.41	0.45
11	03A03-121	Wye, 1/4" MPT x 1/4" FPT x 1/4" FPT	2.36	2.50	2.66	2.80
12	05B01-341	Ball Valve, 1/4" MPT > 1/4" B (with check)	3.95	4.25	4.50	4.95
13a	05B01-337	Ball Valve, 1/4" MPT x 3/8" B (no check)	3.50	3.95	4.50	4.95
13b	05B01-342	Ball Valve, 1/4" MPT > 3/8" B (with check)	4.00	4.30	4.60	4.95
14a	05B01-344	Ball Valve, 1/4" MPT x 1/4" MFL (no check)	3.75	3.95	4.50	4.95
14b	05B01-343	Ball Valve, 1/4" MPT > 1/4" MFL (with check)	3.75	3.95	4.50	4.95
15a	05B01-346	Ball Valve, 1/4" B x 1/4" B Lead Free	4.25	4.50	4.95	5.50
15b	05B01-347	Ball Valve, 3/8" B x 3/8" B Lead Free	4.60	4.85	5.15	5.50

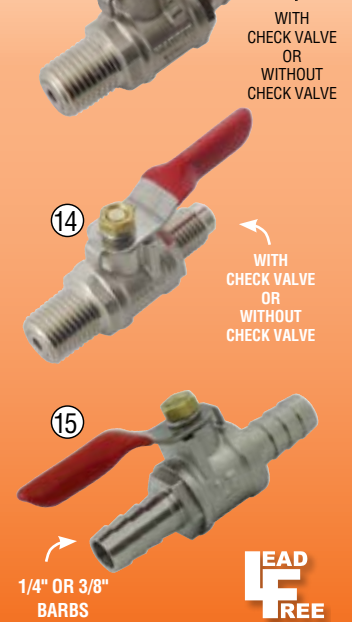

Regulators / Air Distributors Fittings

Additional price breaks available on most items. Login to your website account or contact your sales representative for pricing.

Nitrogen Valve Connectors

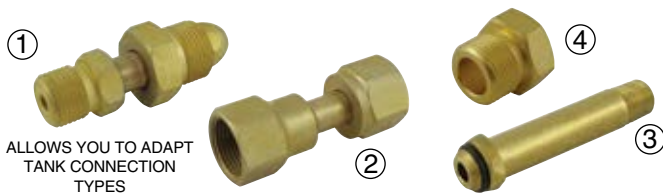

Ref. #	Catalog No.	Description	24+	12+	6+	Each
1	02F08-101	Adapter, N ² Cyl. x CO ₂ Reg.	6.50	6.95	7.25	7.50
2	02F08-111	Adapter, CO ₂ Cyl. x N ² Reg.	6.50	6.75	6.95	7.50
3a	02F08-103	Nipple, Nitrogen 3" L (RHT)	2.05	2.20	2.50	2.95
3b	02A03-105	Nipple, Nitrogen 3" L (LHT)	2.10	2.25	2.50	2.95
4	02F08-102	Nut, Nitrogen	2.50	2.75	2.95	3.50
-	15H06-295	O-ring, (fits ref. #3)	7.38	7.69	8.53	15.00

CO₂ Quick Coupler



Ref.	Catalog No.	Description	50+	25+	Each
1	03B04-101	Male Coupler (5/16" B)	1.75	1.95	2.25
2	03B04-102	Female Coupler (5/16" B)	3.95	4.50	4.95

CO₂ Valve Connectors



Ref. #	Catalog No.	Description	24+	12+	6+	Each
1a	02A03-102	Nipple, CO ₂ (RHT)	1.50	1.75	2.00	2.25
1b	02A03-103	Nipple, CO ₂ (LHT)	1.55	1.75	2.00	2.25
2	02A03-101	Nut, CO ₂	1.95	2.25	2.50	2.95

CO₂ Washers



Ref. #	Catalog No.	Description	300+	100+	25+	Each
1	02C03-188	Hard Fiber Washer	4.95	5.25	-	10.00
2	02H06-294	Nylon Washer	4.95	5.50	-	10.00
3	02H08-111	ABC Permanent O-ring	0.60	0.65	0.70	0.75



(QC) Soda Fountain Systems



1/2 micron filter systems for fountain applications makes beverages taste better and protects equipment from clogging, corrosion and abrasive wear. New and improved MC2 cartridge features Micro-Pure II media with antimicrobial protection to inhibit any potential bacteria growth. Cartridges are quick and easy to change.

Ref. #	Catalog No.	Description	# of Carb Dispensers	# of Syrup Containers	Approx. Capacity	Flow Rate	Each
1	09D02-147	Single MC2 System	1	up to 25/MTH	9,000 gal.	1.67 GPM	205.95
1	09D02-102	Single MC2 System (without gauge)	1	up to 25/MTH	9,000 gal.	1.67 GPM	97.95
2	09D02-148	Dual MC2 System	1	up to 50/MTH	18,000 gal.	3.34 GPM	368.95
3	09D02-149	Triple MC2 System	2	Over 50/MTH	27,000 gal.	5 GPM	535.95
4	09D02-144	Quadruple MC2 System	Up to 4	Over 50/MTH	36,000 gal.	7.3 GPM	776.95



(QC) Insurice Ice Machine Systems

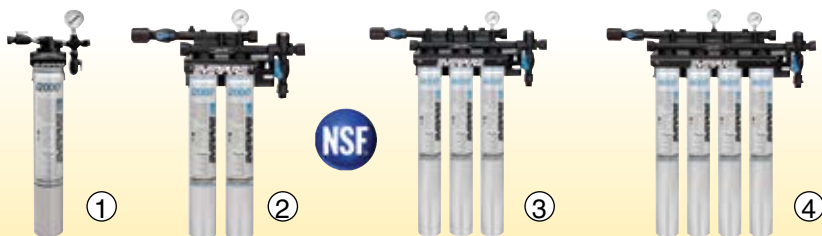

1/2 micron filter systems for ice machine applications. Reduces chlorine taste, odors and other offensive contaminants. Self-contained scale inhibitor feed reduces water-related ice machine problems caused by scale build-up. Cartridges feature Micro-Pure II media with antimicrobial protection to inhibit any potential bacteria growth. Cartridges are quick and easy to change.

Ref. #	Catalog No.	Description	Cubers Lbs per day	Flakers Lbs per day	Approx. Capacity	Flow Rate	Each
1	09D02-135	Single Insurice 2000 System	up to 750 lbs	up to 1,500 lbs	9,000 gal.	1.67 GPM	216.95
2	09D02-136	Dual Insurice 2000 System	up to 1,450 lbs	up to 2,200 lbs	18,000 gal.	3.34 GPM	373.95
3	09D02-129	Triple Insurice 4000 System	High volume	High volume	27,000 gal.	5 GPM	599.95
4	09D02-138	Quadruple Insurice 4000 System	High volume	High volume	36,000 gal.	7.3 GPM	794.95



(QC) Multi-Application Systems



BOTH SYSTEMS COME WITH LOW PRESSURE ALARM FOR CARTRIDGE CHANGE NOTIFICATION

1/2 micron filter systems (with 20" pre-filter and SR-X scale reduction feeder). These combo systems provide higher quality ingredient water for soda fountains, coffee and ice machines. New and improved MC2 cartridges feature Micro-Pure II media with antimicrobial protection to inhibit any potential bacteria growth. Cartridges are quick and easy to change.

Ref. #	Catalog No.	Description	Specifications	Approx. Capacity	Flow Rate	Each
1	09D02-145	Triple Multi-Application System	Depends upon application	27,000 gal.	5.7 GPM	849.95
2	09D02-132	Quadruple Multi-Application System	Depends upon application	36,000 gal.	6.7 GPM	1125.95



(QC) Replacement Cartridges

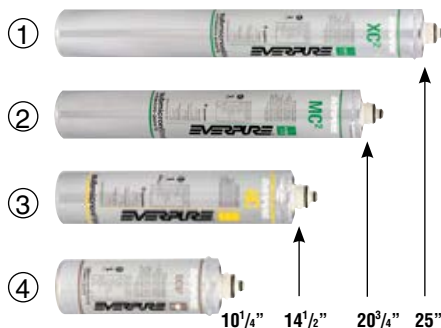

Ref. #	Catalog No.	Description	Micron	Scale Inhibitor	Capacity	12+	6+	Each
1	09D02-124	XC2	1/2	No	12,000 gal	82.95	85.95	89.95
1	09D02-141	i4000	1/2	Yes	12,000 gal	80.95	83.95	86.95
2	09D02-101	MC2	1/2	No	9,000 gal	62.95	65.95	67.95
2	09D02-105	MH2	1/2	Yes	9,000 gal	80.95	83.95	86.95
2	09D02-121	4CB5	5	No	6,000 gal	50.95	52.95	54.95
2	09D02-122	4CB5-S	5	Yes	6,000 gal	59.95	61.95	63.95
2	09D02-125	7CB5	5	No	10,000 gal	65.95	68.95	71.95
2	09D02-126	7CB5-S	5	Yes	10,000 gal	72.95	75.95	78.95
2	09D02-152	7S0	Softener cartridge		2,000 grains	90.95	93.95	97.95
2	09D02-137	i2000	1/2	Yes	9,000 gal	70.95	73.95	76.95
3	09D02-106	4C	1/2	No	3,000 gal	36.95	38.95	39.95
3	09D02-107	4H	1/2	Yes	3,000 gal	46.95	47.95	49.95
4	09D02-127	OCS2	1/2	Yes	1,500 gal	32.95	34.95	35.95
4	09D02-110	2CB5	5	No	3,000 gal	32.95	33.95	34.95

EVERPURE Filter Heads

WITH MOUNTING BRACKETS

EXCLUSIVELY FOR ALL EVERPURE (QC) CARTRIDGES

Ref. #	Catalog No.	Description	24+	12+	Each
1	09D02-162	QL2 Filter Head	26.95	28.95	29.95
2	09D02-133	QL3B Filter Head	34.95	36.95	38.95
3	09D02-157	Shutoff valve (only)	-	-	7.95



①
QL2 HEAD
NO FITTINGS
3/8" FPT IN/OUTLET



②
QL3B HEAD
WITH FITTINGS
3/8" MFL IN/OUTLET



③
SHUTOFF VALVE
REPLACEMENT
FITS QL3B HEAD

EVERPURE SR-X (10") Feeder Replacement Parts



①



②



③

8"



④

10"



⑤

Inhibits
limescale
build-up

EVERPURE IMF (8") Feeder Replacement Parts



⑥



⑦



⑧

"K" gasket (when cut) will have the appearance of the letter K -- as depicted below.

Ref. #	Catalog No.	Description	12+	6+	Each
1	09D02-100	SR-X Feeder (complete w/scalestick)	142.95	147.95	151.95
2	09S03-113	Wrench, 10" bowl (black)	3.46	3.74	4.00
3	09D02-131	Scalestick, SS-IMF (8") works with an additional spacer	48.95	50.95	52.95
4	09D02-154	Scalestick, SS-10 (10") works with all 10" Everpure bowls	58.95	60.95	63.95
5	09D02-170	O-ring Replacement SR-X	2.05	2.17	2.29
6	09D02-131	Scalestick, SS-IMF (8")	48.95	50.95	52.95
7	09D02-150	O-ring Replacement IMF (threads on outside of bowl)	4.89	5.17	5.47
7	09D02-170	O-ring Replacement IMF (threads on inside of bowl)	2.05	2.17	2.29
8	09D02-140	"K" Gasket, Replacement IMF (for oldest style IMF)	15.59	16.11	16.89

Water Filtration Systems

EVERPURE "E" Pre-Filters

EXTENDS LIFE OF SUBMICRON CARTRIDGES



①

3/4" FPT
Inlets/Outlets



②

20"



③



④

10"



⑤

Replacement O-Rings

09D02-150

For "K" series pre-filters with threads on outside of bowl

09D02-170

For "E" series pre-filters with threads on inside of bowl

(QC) Taste/Odor Cartridges



14"



12"

ALSO AVAILABLE WITH
SCALE INHIBITOR

For use with
EVERPURE
(QC) TYPE HEADS

Simply push into a Everpure (QC) filter head and twist to lock into place.

**NO ADAPTERS
REQUIRED!**

(WILL NOT FIT QL3B HEAD)

Ref. #	Catalog No.	Description	12+	6+	Each
1	09D02-130	Prefilter, "E" Series, 20"	-	-	101.95
2	09D02-109	Cartridge, Replacement 20"	8.26	8.59	8.95
3	09D02-112	Prefilter, "E" Series, 10"	-	-	63.95
4	09D02-113	Cartridge, Replacement 10"	4.43	4.64	4.95
5	09D02-150	O-ring, "K" Series	4.89	5.17	5.47
5	09D02-170	O-ring, "E" Series	2.05	2.17	2.29

Taste & Odor Plus Scale Inhibitor

Catalog No.	Length	Micron	Capacity	10+	5+	Each
09I01-133	12"	10	2,000 gal.	15.56	16.19	16.88
09I01-134	14"	10	2,500 gal.	17.50	18.50	19.50

Ice Machine and Soda Fountain Filtration Systems

NOW FEATURES NO-TOOLS REQUIRED QUICK CHANGE CARTRIDGES AND BUILT-IN AUTO SHUTOFF



ICE SYSTEMS

Reduce sediment, chlorine, taste, odors and scale

- ICE 125-S (1 Micron)
- ICE 145-S (3 Micron)
- ICE 165-S (3 Micron)
- ICE 195-S (3 Micron)



SODA SYSTEMS

Reduce sediment, chlorine, taste, and odors

- BEV 135 (1 Micron)
- BEV 145 (3 Micron)
- BEV 165 (3 Micron)
- BEV 195 (3 Micron)



One cartridge does it all!

ICE MACHINE SYSTEMS

Ref.	Catalog No.	Description	Flow Rate	Capacity	Each
1	09A05-152	Ice 125-S	1.5 GPM	10,000 gal	147.95
2	09A05-153	Ice 145-S	2.1 GPM	25,000 gal	193.95
3	09A05-154	Ice 165-S	3.34 GPM	35,000 gal	222.95
4	09A05-155	Ice 195-S	5.0 GPM	54,000 gal	278.95

SODA FOUNTAIN SYSTEMS

Ref.	Catalog No.	Description	Flow Rate	Capacity	Each
1	09A05-157	Bev 135	1.67 GPM	12,600 gal	153.95
2	09A05-158	Bev 145	2.1 GPM	25,000 gal	190.95
3	09A05-159	Bev 165	3.34 GPM	35,000 gal	263.95
4	09A05-160	Bev 195	5.0 GPM	54,000 gal	283.95

ICE MACHINE REPLACEMENT CARTRIDGES

Catalog No.	Description	6+	3+	Each
09A05-199	For Ice 125-S	49.95	51.95	53.95
09A05-200	For Ice 145-S	86.95	88.95	91.95
09A05-201	For Ice 165-S	116.95	119.95	122.95
09A05-202	For Ice 195-S	171.95	175.95	180.95

SODA FOUNTAIN REPLACEMENT CARTRIDGES

Catalog No.	Description	6+	3+	Each
09A05-198	For Bev 135	55.95	58.95	60.95
09A05-203	For Bev 145	84.95	86.95	88.95
09A05-204	For Bev 165	111.95	114.95	117.95
09A05-205	For Bev 195	166.95	170.95	174.95

Coffee & Tea Brewers Filtration Systems



REDUCES SEDIMENT, CHLORINE, TASTE, ODORS AND SCALE
BOTH SYSTEMS ARE 1 MICRON RATED **3/8" FTP INLET/OUTLET**



COFFEE AND TEA BREWERS SYSTEMS

Catalog No.	Mfg. No.	Description	Flow Rate	Capacity	Each
09A05-300	56160-02	BREW125-MS	1.5 GPM	10,000 gallon	107.95
09A05-301	56161-04	BREW130-MS	1.67 GPM	12,600 gallon	119.95

COFFEE AND TEA BREWERS REPLACEMENT CARTRIDGES

Catalog No.	Mfg. No.	Description	6+	3+	Each
09A05-310	56152-09	For Brew125-MS	50.95	52.95	55.95
09A05-311	56151-11	For Brew130-MS	63.95	65.95	68.95

Cuno 8000 System One and Iceasure Cartridges



CFS8112-S: 1 micron rated • 1.5 gpm flow rate • 10,000 gallon capacity
CFS8720-S: 5 micron rated • 1.5 gpm flow rate • 4,800 gallon capacity



Catalog No.	Mfg. No.	Description	6+	3+	Each
09A05-131	CFS8112-S	Cartridge (Chlorine Taste/Odor/Scale)	51.95	54.95	55.95
09A05-134	CFS8720-S	Cartridge (Chlorine Taste/Odor/Scale/Particulate)	45.95	46.95	49.95





Quick Change Modular Filter Systems

WITH HOLLOW CARBON TECHNOLOGY & TURBO DESIGN

Hollow carbon technology contains small void spaces that act as a mechanical super-filter. This property removes dust particles while eliminating the need for a membrane or prefilter. Yet the filter technology still allows high flow rates and low pressure drops. Surrounding the carbon is an exclusive high porosity shell, a porous wrapper that ensures the maximum efficiency of the hollow carbon particles within.

The result is excellent reduction of chlorine, chloramine, odor, live cyst, microspheres and turbidity. The combination of hollow carbon particles and the turbo design ensures much higher contact time compared to traditional flow designs. SMF Systems provide ten times the capacity of conventional filters for particulate removal.



QUICK CHANGE CARTRIDGES CAN BE USED IN OLDER SYSTEMS BY USING AN ADAPTER

CALL FOR MORE INFORMATION

ALL SMF SYSTEMS
Quickly and easily join together to increase capacity or to create custom configurations

Catalog No.	Mfg. No.	Application	Flow Rate	Rated Capacity Chlorine	Rated Capacity Chloramine	Rated Capacity Scale Inhibitor	Each
09S03-200	QC 500F	Fountain	2.5 GPM	11,000 gal.	6,000 gal.	-	179.95
09S03-201	IC 600	Fountain	2.5 GPM	50,000 gal.	7,000 gal.	-	305.95
09S03-202	IC 620	Fountain	5 GPM	100,000 gal.	30,000 gal.	-	415.95
09S03-203	IM 600	Ice Machine	7 GPM	-	-	75,000 gal.	330.95
09S03-204	ICE PRO	Ice Machine & FCB	5 GPM	50,000 gal.	15,000 gal.	13,000 gal.	320.95

Replacement Cartridge	Mfg. No.	Each
09S03-205	QC 500-2	116.95
09S03-206	108-010	154.95
09S03-207	108-020	260.95
09S03-208	109-010-S	179.95
09S03-209	108-0101-P	170.95



Quick Change Coffee Pro Filter Systems

Reduces: Chlorine, Chloramine, Sediment, (Particulate Class 1), THM, Organics, Tannins, Bad Tastes, Odors and inhibits Scale

WATER FILTRATION SYSTEMS FOR COFFEE APPLICATIONS

Catalog No.	Mfg. No.	Flow Rate	Rated Capacity Chlorine	Rated Capacity Chloramine	Rated Capacity Scale Inhibitor	Each
09S03-210	IC 600 CP	5 GPM	50,000 gal.	15,000 gal.	15,000 gal.	320.95
09S03-211	IC 620 CP	5 GPM	100,000 gal.	30,000 gal.	30,000 gal.	329.95

Catalog No.	Mfg. No.	Description	Each
09S03-215	108-010 CF	Replacement Cartridge for: IC 600 CP Filter System	170.95
09S03-216	108-020 CF	Replacement Cartridge for: IC 620 CP Filter System	206.95



NSF Selecto Drop-in Cartridges

Selecto Filter Housing O-Rings & Wrenches

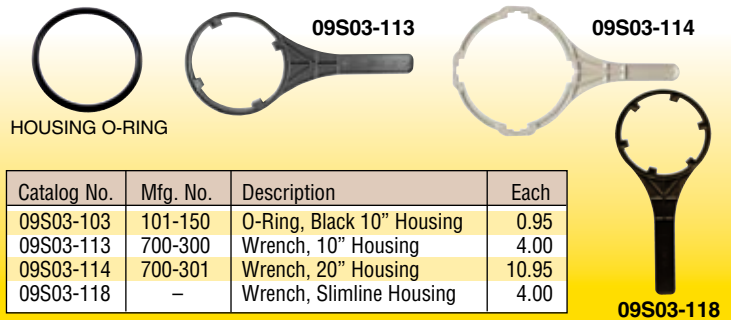
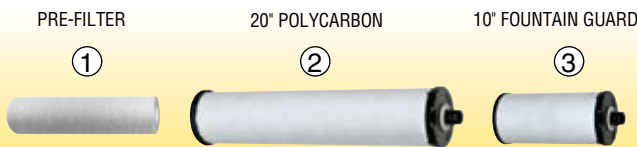

Ref. #	Catalog No.	Mfg. No.	Replacement Cartridges	Each
1	09S03-108	101-230	Pre-filter 5 Micron	5.45
2	09S03-112	101-300	Polycarbon 20"	208.95
3	09S03-115	101-290	Fountain Guard 10"	110.95

Catalog No.	Mfg. No.	Description	Each
09S03-103	101-150	O-Ring, Black 10" Housing	0.95
09S03-113	700-300	Wrench, 10" Housing	4.00
09S03-114	700-301	Wrench, 20" Housing	10.95
09S03-118	-	Wrench, Slimline Housing	4.00

Replacement Cartridges for 10" & 20" Housings

Purtrex™ Depth Filters (Sediment Removal) - Provides: High volume sediment removal
 Blown microfiber technology meets the market requirements for a pure polypropylene depth filter with exceptional dirt-holding capability. Provides longer life and fewer changeouts than existing string-wound or resin bonded filters. An exceptional value for general applications.



Catalog No.	Description	20+	10+	5+	Each
09I01-111	Purex 10" (5 micron)	2.26	2.40	2.55	2.67

Catalog No.	Description	20+	10+	5+	Each
09I01-113	Purex 20" (5 micron)	3.85	4.12	4.30	4.57

Poly-Pleat™ Pleated Filters (Sediment/Cyst Removal) - Provides: Safe, cyst-free drinking water
 Pleated polypropylene filter media provides more surface area for longer filter life and increased particle removal. End caps, center tubes and media are thermally bonded as one integral component for added strength and to provide superior end sealing. FDA listed materials.



Catalog No.	Description	24+	12+	6+	Each
09I01-112	10" (Absolute 1 micron)	21.79	22.21	23.60	24.99

Omnipure™ Carbon Block Filters (Taste/Odor/Chlorine Removal) - Provides: Clarified drinking water
 Features OmnipureBlock™ coconut shell carbon block media, finished with polypropylene netting and end caps and compression gaskets. Significantly reduces: Chlorine, bad tastes and odors, turbidity (cloudy water), VOC's (volatile organic chemicals), pesticides and more.



Catalog No.	Description	20+	10+	5+	Each
09I01-115	10" (10 micron)	5.34	5.65	6.01	6.30



In-Line Water Filtration Cartridges

TSTWATER® GAC Filters (Taste/Odor/Chlorine Removal) - Provides: Clarified drinking water
 TST In line filters are constructed from the highest quality coconut shell GAC and specially selected plastics to give our customers some of the best performing filters in the industry. Also available with phosphates to aid in the control of scale and lime deposits.



- 1/4" FPT inlet and outlet
- Temp. range: 40-100F
- Pressure range: 20-125 PSI



COCO GAC - Removes chlorine, bad tastes, odors, dirt & rust
PHOSPHATE - Inhibits formation of scale and lime build-up

Catalog No.	Description	25+	10+	5+	Each
09A01-200	6" COCO GAC	6.40	6.69	7.10	7.45
09A01-201	10" COCO GAC	7.88	8.23	8.74	9.17
09A01-202	6" COCO GAC, + Phosphates	8.23	8.59	9.13	9.58
09A01-203	10" COCO GAC, + Phosphates	12.25	12.79	13.59	14.26

FLOJET® Electric Bottled Water System

DELIVERS BOTTLED WATER TO COFFEE MACHINES, BEVERAGE DISPENSERS, VENDING MACHINES, PORTABLE VENDING CARTS, ETC.



15F01-225

6+ **\$118.95**

3+ \$123.95 Ea. \$128.95

INCLUDES:

- Base Unit with on/off rocker switch
- Suction wand and hose assembly
- 20' of 1/4" discharge tube w/compression nut
- 6' length wall power transformer

115V / 60Hz / .4 amp
 Max pressure 40 PSI
 Weight: 5 lb.

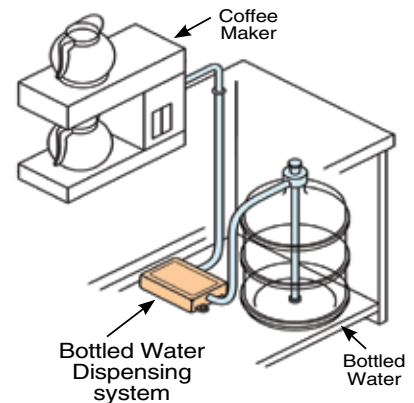

SHURflo® Electric Water Booster System

Delivers increased water pressure to non-carb dispensing valves, filtration systems, supply carbonators, coffee machines, etc. Use where low pressure, fluctuating pressure or no pressure exists.

6' POWER CORD 3-PRONG

Ref. #	Catalog No.	Description	12+	6+	Each
1	09C07-117	60 PSI Pump (3/8" FPT in/out)	139.95	147.95	155.95
1	09C07-118	90 PSI Pump (3/8" FPT in/out)	149.95	153.95	159.95
NO POWER CORD – SET UP FOR HARD WIRE INSTALLATION					
1	15C07-137	45 PSI Pump (1/2" MPT in/out)	60.95	62.95	66.95

Ref. #	Catalog No.	Description	25+	10+	Each
2	05C07-116	Hose stem, 3/8" B x 1/2" FPT	1.75	1.86	1.95
2	05C07-117	Hose stem, 1/2" B x 1/2" FPT	2.38	2.53	2.65
3	05C07-113	Elbow, 3/8" B x 1/2" FPT	2.15	2.25	2.38

- NSF, UL, CSA listed
- Self-priming up to 8 vertical feet
- Can run pump dry without damage
- 115V / 60Hz



FLOJET® CO₂/Air Driven Water Booster Pump

Delivers increased water pressure to non-carb dispensing valves, filtration systems, supply carbonators, coffee machines, etc. Use where low pressure, fluctuating pressure or no pressure exists.

Catalog No.	Description	12+	6+	Each
09F01-101	20 PSI to 90 PSI (Max) pump	53.95	56.95	59.95



- NSF listed
- Self-priming up to 10 feet
- Operating pressure range: 20-90 PSI
- Required: 30 PSI water regulator
- Gas inlet: 1/4" barb
- Liquid inlet/outlet: 1/2" barb

Additional price breaks available on most items. Login to your website account or contact your sales representative for pricing.

SHURflo® Electric Water Booster System

Delivers consistent increased water pressure to one or more applications. Use where low, fluctuating or no pressure exists.

FEATURES

- Pump & tank are NSF, UL, CSA listed
- Self-priming up to 8 vertical feet
- Can run pump dry without damage
- 21 oz. Accumulator tank
- 6' Power cord
- Liquid inlet/outlet: 3/8" barb
- 115V / 60Hz
- 9-1/2" W x 10-1/2" D x 4-1/2" H

Ref.#	Catalog No.	Description	4+	2+	Each
1	09C07-123	60 PSI Water Booster System	164.95	168.95	172.95
1	09C07-124	90 PSI Water Booster System	164.95	168.95	172.95
-	09C07-121	Accumulator only Tank (21 oz)	41.95	43.95	45.95
2	04C03-196	Water Inlet fitting 3/8" barb (S/S)	6.22	6.61	6.94
-	15H06-295	O-ring (for water inlet fitting)	-	-	.15

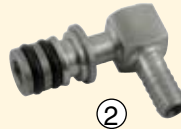

WATER INLET S/S FITTING
3/8" Barb

FITS:
SHURFLO & McCANN'S WATER BOOSTERS



FLOJET® CO₂/Air Driven Water Booster System

Delivers consistent increased water pressure to one or more applications. Use where low, fluctuating or no pressure exists.

FEATURES

- NSF listed pump and tank
- Self-priming up to 10 feet
- Quiet operation
- Operating pressure range: 60-90 PSI
- Required: 30 PSI water regulator
- 1/2 gallon accumulator tank
- Gas inlet/outlet: 1/4" barb
- Liquid inlet/outlet: 1/2" barb
- 12" H x 11-1/2" W x 7" D



Catalog No.	Description	4+	2+	Each
09F01-201	60 to 90 PSI (Max) System	237.95	243.95	250.95

McCann's® ELECTRIC Water Booster System

Delivers consistent increased water pressure to one or more applications. Use where low, fluctuating or no pressure exists.

FEATURES

- NSF and UL listed pump and tank
- Self-priming up to 10 feet
- Operating pressure range: 80-100 PSI
- 180 PSI relief on tank
- 2 gallon accumulator tank
- Liquid inlet/outlet: 3/8" barb
- 9-1/2" H x 15-1/2" W x 14" D



Catalog No.	Description	4+	2+	Each
09T07-112	80 PSI to 100 PSI (Max) System	366.95	389.95	410.95
09T07-113	Pump only (Aquatec)	121.95	126.95	131.95
04C03-196	Water inlet fitting 3/8" barb (S/S)	6.22	6.61	6.94

WATTS® Adjustable Water Pressure Regulators

IDEAL FOR BEVERAGE EQUIPMENT, DRINKING FOUNTAINS, ICE MACHINES, HUMIDIFIERS & MORE!

THE INDUSTRY'S MOST POPULAR WATER PRESSURE REGULATOR

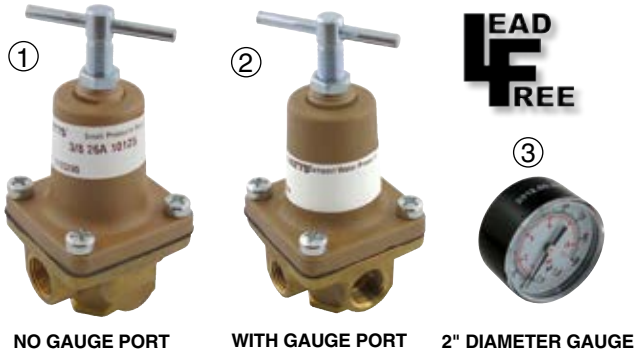

- Regulates city/main water pressure
- Maximum primary pressure 300 psi
- Forged brass body (lead free)
- 2" square x 4-1/4" height

Ref.#	Catalog No.	Pressure Range	Inlet Outlet	20+	10+	5+	Each
1	09K06-101	3 - 50 lb.	3/8" FPT	65.95	67.95	70.95	72.95
1	09K06-102	10-125 lb.	3/8" FPT	71.95	73.95	76.95	79.95
2	09K06-105	3 - 50 lb.	3/8" FPT	89.95	92.95	96.95	100.95
2	09K06-106	10-125 lb.	3/8" FPT	89.95	92.95	96.95	100.95
3	03G07-150	0-160 lb.	-	3.25	3.50	3.75	4.00

Water Filtration Miscellaneous and Bottled Water System

FLOJET® Pre-Set Water Pressure Regulator

- Minimizes input water pressure fluctuations
- Guards against high incoming spikes of pressure
- Regulates city/main water pressure
- Temperature range 34° to 120°F
- Polypropylene body and stainless steel 3/8" B



Catalog No.	Pre-Set	20+	10+	5+	Each
09F01-110	30 psi	14.95	15.95	16.95	17.95
09F01-111	50 psi	14.95	15.95	16.95	17.95

SHURflo® Pre-Set Water Pressure Regulator

- Minimizes input water pressure fluctuations
- Guards against high incoming spikes of pressure
- Regulates city/main water pressure
- Temperature range 34° to 120°F
- Polypropylene body and stainless steel 3/8" B



Catalog No.	Pre-Set	20+	10+	5+	Each
09C07-113	30 psi	21.50	21.95	22.95	23.95
09C07-115	50 psi	21.50	21.95	22.95	23.95

3-Way Compression Adapt-A-Valve

PERFECT FOR ADDING AN ADDITIONAL WATER SUPPLY LINE

FOR ICE MAKERS, COFFEE MAKERS, INSTANT HOT WATER SYSTEMS, ETC.

Lead free brass • For hot or cold applications • Maximum pressure 400 psi

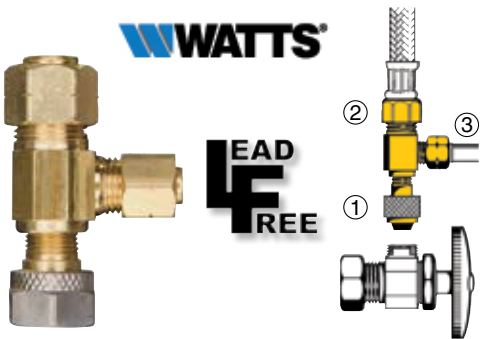

Catalog No.	O.D. ①	O.D. ②	O.D. ③	100+	25+	10+	Each
05K06-102	3/8" C	3/8" C	3/8" C	5.50	5.95	6.50	6.95

Heavy Duty Self Piercing Saddle Valve

DESIGNED TO HANDLE CARBONATORS
Fits 5/8" O.D. to 7/8" O.D. pipe or tube
Has a 3/8" MFL outlet



05L03-102
10+ \$25.54 5+ \$24.12 Ea. \$27.14

Economy Self Piercing Saddle Valve

DESIGNED FOR ADDING A WATER LINE
Fits 3/8" O.D. to 1-3/8" O.D. copper tube
Has a 1/4" O.D. compression outlet



05B01-130
10+ \$3.50 5+ \$3.75 Ea. \$3.95

Compression Fitting Adapters

Catalog No.	Description	100+	50+	25+	Ea.
05C03-110	1/4 Compression x 1/4 MFL	0.96	1.05	1.10	1.15
05C03-111	1/4 Compression x 3/8 MFL	1.33	1.41	1.49	1.57
05C03-112	3/8 Compression x 1/4 MFL	1.25	1.30	1.40	1.50
05C03-113	3/8 Compression x 3/8 MFL	1.41	1.49	1.57	1.71

Catalog No.	Description	100+	50+	25+	Ea.
05B01-331	1/4 Compression x 1/4 Barb	0.81	0.86	0.90	0.99
05B01-330	3/8 Compression x 3/8 Barb	1.25	1.30	1.40	1.50

Catalog No.	Description	100+	50+	25+	Ea.
04C03-380	1/4 Compression x 1/4 Barb	1.20	1.28	1.34	1.46
04C03-381	3/8 Compression x 1/4 Barb	0.95	1.05	1.15	1.25
04C03-382	3/8 Compression x 3/8 Barb	1.20	1.30	1.40	1.50

BRASS
COMPRESSION
TO MALE FLARE

BRASS
COMPRESSION
TO BARB

STAINLESS
COMPRESSION
TO BARB



Refrigeration Grade Soft Copper Tubing

PRICED PER 50' ROLL

Catalog No.	O.D. Size	20+	10+	5+	Each
05D05-101	1/4"	28.95	29.95	30.95	31.95
05D05-102	3/8"	40.95	41.95	42.95	44.95
05D05-110	1/2"	55.95	57.95	58.95	61.95

- Specifically for water lines
- Flexible and easy to work with
- Has a .024 wall thickness
- Each roll has been cleaned, capped and individually packaged
- Meets ASTM and NSF standards

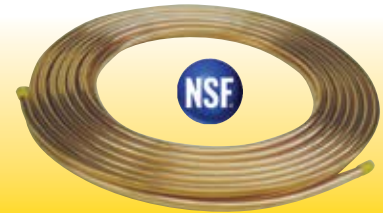

Push-Back Style Glass Fillers

- Pedestal types have 8" clearance
- Includes: Coupling nut and 1/4" sweat tailpiece for connection or order 04E04-391 & 02H06-294 to convert to a 1/4" barb



Ref. #	Catalog No.	Description	Each
1	12C03-192	Wall Mount	122.95
2	12M03-101	Pedestal Mount*	144.95
3	12M03-104	Pedestal Mount with Drain	275.95
-	12M03-102	Lever only (New style)	18.95
-	12M03-105	Repair Kit (New style)	28.95
-	12M03-103	Repair Kit (Old style)	34.95

Additional price breaks available on most items. Login to your website account or contact your sales representative for pricing.

Self-Closing Faucets

IDEAL FOR DISPENSING WATER,
HOT OR COLD BEVERAGES,
CERTAIN CHEMICALS AND INDUSTRIAL LIQUIDS

Ref. #	Catalog No.	Description	Each
1	12J09-104	1/2" MPT (SPB)	12.95
2	12J09-107	1/2"-16 UNF	6.95
2	12J09-102	3/4"-16 UNF	9.50
3	12J09-103	1/2" Barb (FHSB)	11.95



"No Drip" Seal



Accuflex Quality Hose and Tubing

THE RECOGNIZED LEADER IN BEVERAGE TRANSFER PRODUCTS

140° Fahrenheit is the maximum operating temperature for all items listed



BEVLEX® – Your Value Choice

Economically priced • Taste and odor resistant • Stress crack resistant
Moderately flexible • NSF 51 & 61 certified • FDA compliant

Bevlex® Series 200 CRYSTAL CLEAR VINYL DUAL DUROMETER CONSTRUCTION

• Very flexible • Excellent kink resistance • Taste protection properties • Phthalate FREE



FOR B-I-B SUCTION LINES						PRICES PER 100'			PRICE PER FOOT
Catalog No.	I.D.	O.D.	Working Pressure at 70° F	Clamp Index	Roll Size	4 Rolls	2 Rolls	1 Roll	Under 100'
08A05-126	3/8"	5/8"	50	J	100'	26.13	28.00	29.70	.60

Bevlex® Series 222 Thinwall SEMI-TRANSPARENT POLYETHYLENE NON-BARRIER

• Inexpensive • Odorless and tasteless • Kink resistant



ACCEPTABLE FOR PRODUCT LINES						PRICES PER 100'			PRICE PER FOOT	
Catalog No.	I.D.	O.D.	Working Pressure at 70° F	Clamp Index	Roll Size	4 Rolls	2 Rolls	1 Roll	100' Section	Under 100'
08H05-154	11/64"	1/4"	125	–	2000'	-	-	6.79	-	.13
08H05-115	1/4"	3/8"	125	B	500'	11.36	12.17	12.91	14.69	.25
08H05-116	3/8"	1/2"	100	F	500'	15.75	16.87	17.89	20.36	.40
08H05-117	1/2"	5/8"	75	H	500'	20.75	22.23	23.58	26.83	.50

Bevlex® Series 170 POLYESTER-REINFORCED POLYETHYLENE WITH COPOLYMER JACKET

• Increased pressure performance • Excellent resistance to kinks and stress cracks
• Copolymer jacket is abrasion resistant

APPROVED BY MAJOR BOTTLERS



IDEAL FOR PRODUCT LINES						PRICES PER 100'			PRICE PER FOOT	
Catalog No.	I.D.	O.D.	Working Pressure at 70° F	Clamp Index	Roll Size	4 Rolls	2 Rolls	1 Roll	100' Section	Under 100'
08H05-151	1/4"	15/32"	300	C	500'	16.96	18.17	19.27	21.93	.40
08H05-153	1/4"	17/32"	300	F	500'	24.81	26.59	28.20	32.09	.60
08H05-152	3/8"	19/32"	300	G	300'	27.43	29.39	31.17	35.47	.60
08H05-155	1/2"	3/4"	250	K	500'	51.44	55.11	58.45	66.52	1.20

Bevlex® Series 174 POLYESTER-REINFORCED POLYETHYLENE WITH MYLAR BARRIER

• Barrier helps prevent taste and odor permeation • Plus all the features of Series 170



HELPS MAINTAIN TASTE INTEGRITY						PRICES PER 100'			PRICE PER FOOT	
Catalog NO.	I.D.	O.D.	Working Pressure at 70° F	Clamp Index	Roll Size	4 Rolls	2 Rolls	1 Roll	100' Section	Under 100'
08G03-105 (RED)	1/4"	15/32"	300	C	500'	23.79	25.49	27.03	30.76	.50
08G03-107 (RED)	1/4"	17/32"	300	F	500'	23.79	25.49	27.03	30.76	.50
08G03-110 (RED)	3/8"	5/8"	300	H	300'	34.21	36.66	38.88	44.24	.80

Bevlex® Series 180 JACKETED POLYESTER-REINFORCED POLYETHYLENE WITH GLAS-FLEX™

• Use after filtered water where algae can be a concern • Jacket prevents light from entering line preventing algae growth • Glas-Flex™ liner is non-porous, non-reactive, odorless, tasteless and provides superior barrier, cleanability and flushability • Allows quick flavor changes, including pungent flavors

APPROVED BY MAJOR BOTTLERS



HELPS PREVENT ALGAE GROWTH						PRICES PER 100'			PRICE PER FOOT	
Catalog No.	I.D.	O.D.	Working Pressure at 70° F	Clamp Index	Roll Size	4 Rolls	2 Rolls	1 Roll	100' Section	Under 100'
08H05-157	1/4"	29/64"	300	E	100'	32.37	34.69	36.79	-	.60
08H05-158	3/8"	19/32"	300	G	100'	40.25	43.13	45.74	-	.80
08H05-159	1/2"	3/4"	200	K	100'	60.07	64.36	68.26	-	1.20



Tubing (Soda Related)

Accuflex Quality Hose and Tubing

THE RECOGNIZED LEADER IN BEVERAGE TRANSFER PRODUCTS
 140° Fahrenheit is the maximum operating temperature for all items listed



CLEARBRAID® & BEV-FLEX® – Your Flexible Choice

Extremely flexible and kink resistant • Very tight bend radius • Taste and odor resistant • Stress crack resistant • NSF 51 & 61 certified • FDA compliant

Clearbraid® Series K3150 CRYSTAL CLEAR PVC WITH POLYESTER REINFORCEMENT

• Ultra flexible • Excellent kink resistance • Polyester provides increased pressure performance while reducing elongation • Phthalate FREE

IDEAL FOR WATER AND JUICE LINES						PRICES PER 100'			PRICE PER FOOT	
Catalog No.	I.D.	O.D.	Working Pressure at 70° F	Clamp Index	Roll Size	4 Rolls	2 Rolls	1 Roll	Under 100'	
08H05-167	3/16"	3/8"	250	B	100'	20.85	22.34	23.70	.45	
08H05-367	3/16"	3/8"	250	B	300'	20.05	20.58	21.72	–	
08H05-161	1/4"	7/16"	250	C	100'	22.33	23.93	25.38	.50	
08H05-361	1/4"	7/16"	250	C	300'	21.47	22.04	23.26	–	
08H05-160	5/16"	17/32"	250	G	100'	35.73	38.29	40.61	.80	
08H05-360	5/16"	17/32"	250	G	300'	34.36	35.26	37.22	–	
08H05-162	3/8"	19/32"	225	H	100'	40.20	43.07	45.68	.80	
08H05-362	3/8"	19/32"	225	H	300'	38.65	39.67	41.88	–	
08H05-163	1/2"	3/4"	200	I	100'	41.69	44.67	47.38	.90	
08H05-363	1/2"	3/4"	200	I	300'	40.09	41.14	43.43	–	
08H05-164	5/8"	57/64"	200	Q	100'	80.65	86.41	91.65	1.50	
08H05-165	3/4"	1-1/32"	150	P	100'	89.71	96.11	101.94	1.70	
08H05-166	1"	1-3/10"	125	-	100'	148.39	158.99	168.62	3.00	

OUR MOST FLEXIBLE TUBING!

Phthalate FREE



Tubing (Soda Related)

Superflex Foxx Brand POLYETHYLENE WITH POLYESTER REINFORCEMENT

• Highly flexible • Odorless and tasteless • Kink resistant • Increased pressure performance

IDEAL FOR PRODUCT LINES						PRICES PER 100'			PRICE PER FOOT	
Catalog No.	I.D.	O.D.	Working Pressure at 70° F	Clamp Index	Roll Size	4 Rolls	2 Rolls	1 Roll	100' Section	Under 100'
08G03-111	1/4"	29/64"	250	C	500'	24.83	26.60	28.21	32.10	.60
08E08-102	3/8"	5/8"	200	H	300'	41.97	44.97	47.70	54.28	1.00

Bev-Flex® Series 172 POLYESTER REINFORCED POLYETHYLENE WITH EVA COVER

• Extremely flexible • Excellent resistance to kinks and stress cracks • EVA cover allows for a very tight bend radius for those "hard to install" locations

APPROVED BY MAJOR BOTTLERS

VERY TIGHT BEND RADIUS!

IDEAL FOR PRODUCT LINES						PRICES PER 100'			PRICE PER FOOT	
Catalog No.	I.D.	O.D.	Working Pressure at 70° F	Clamp Index	Roll Size	4 Rolls	2 Rolls	1 Roll	100' Section	Under 100'
08H05-100	1/4"	27/64"	250	D	500'	19.68	21.09	22.36	25.45	.50
08H05-101	1/4"	15/32"	250	C	500'	19.67	21.07	22.35	25.43	.50
08H05-102	3/8"	5/8"	200	H	300'	29.96	32.10	34.05	38.74	.70
08H05-103	1/2"	3/4"	200	K	100'	46.09	49.39	52.38	–	1.00
08H05-133	1/2"	3/4"	200	K	300'	44.32	45.49	48.01	–	–
WITH RED TRACER THREAD										
08H05-104	1/4"	15/32"	250	C	500'	19.68	21.09	22.36	25.45	.50
08H05-107	3/8"	5/8"	200	H	300'	29.96	32.10	34.05	38.74	.70
WITH BLUE TRACER THREAD										
08H05-105	1/4"	15/32"	250	C	500'	19.68	21.09	22.36	25.45	.50
08H05-108	3/8"	5/8"	200	H	300'	29.96	32.10	34.05	38.74	.70



Accuflex Quality Hose and Tubing

THE RECOGNIZED LEADER IN BEVERAGE TRANSFER PRODUCTS

140° Fahrenheit is the maximum operating temperature for all items listed



BEV-SEAL ULTRA® – Your *Barrier* Choice

Flushable Glas-Flex™ liner allows changeovers from even the most pungent flavors with simple flushing procedures • Unsurpassed oxygen and flavor protection combined with flushability in a co-extruded tube • NSF 51 & 61 certified • FDA compliant

Bev-Seal Ultra® Series 235 POLYOLEFIN TUBE WITH INTERNAL DUAL BARRIER

- Prevents flavor permeation • Works well with pungent flavors • Lightweight
- Allows quick flavor changeovers without taste transfer

APPROVED BY MAJOR BOTTLERS



PREVENTS FLAVOR PERMEATION							PRICES PER 100'				PRICE PER FOOT
Catalog No.	I.D.	O.D.	Working Pressure at 70° F	Clamp Index	Roll Size	4 Rolls	2 Rolls	1 Roll	100' Section	Under 100'	
08H05-249	1/4"	3/8"	125	B	500'	16.71	17.90	18.98	21.60	.40	
08H05-248	5/16"	7/16"	100	C	500'	19.95	21.37	22.67	25.79	.50	
08H05-250	3/8"	1/2"	100	F	500'	23.09	24.74	26.24	29.86	.60	
08H05-251	1/2"	5/8"	75	H	500'	31.75	34.01	36.08	41.05	.70	

Tubing (Soda Related)

PREVENTS FLAVOR PERMEATION								PRICES PER 100'				PRICE PER FOOT
Catalog No.	I.D.	O.D.	Number	Color	Working Pressure at 70° F	Clamp Index	Roll Size	4 Rolls	2 Rolls	1 Roll	100' Section	Under 100'
1/4" COLOR CODED AND NUMBERED												
08H05-601	1/4"	3/8"	1	Blue	125	B	500'	16.71	17.90	18.98	21.60	.40
08H05-602	1/4"	3/8"	2	Black	125	B	500'	16.71	17.90	18.98	21.60	.40
08H05-603	1/4"	3/8"	3	Red	125	B	500'	16.71	17.90	18.98	21.60	.40
08H05-604	1/4"	3/8"	4	Green	125	B	500'	16.71	17.90	18.98	21.60	.40
08H05-605	1/4"	3/8"	5	Yellow	125	B	500'	16.71	17.90	18.98	21.60	.40
08H05-606	1/4"	3/8"	6	Orange	125	B	500'	16.71	17.90	18.98	21.60	.40
08H05-607	1/4"	3/8"	7	Gold	125	B	500'	16.71	17.90	18.98	21.60	.40
08H05-608	1/4"	3/8"	8	White	125	B	500'	16.71	17.90	18.98	21.60	.40
08H05-609	1/4"	3/8"	9	Pink	125	B	500'	16.71	17.90	18.98	21.60	.40
08H05-610	1/4"	3/8"	10	Purple	125	B	500'	16.71	17.90	18.98	21.60	.40
08H05-611	1/4"	3/8"	11	Black	125	B	500'	16.71	17.90	18.98	21.60	.40
08H05-612	1/4"	3/8"	12	Red	125	B	500'	16.71	17.90	18.98	21.60	.40
08H05-613	1/4"	3/8"	13	Green	125	B	500'	16.71	17.90	18.98	21.60	.40
08H05-614	1/4"	3/8"	14	Yellow	125	B	500'	16.71	17.90	18.98	21.60	.40
3/8" COLOR CODED AND NUMBERED												
08H05-301	3/8"	1/2"	1	Blue	100	F	500'	23.09	24.74	26.24	29.86	.60
08H05-302	3/8"	1/2"	2	Black	100	F	500'	23.09	24.74	26.24	29.86	.60
08H05-303	3/8"	1/2"	3	Red	100	F	500'	23.09	24.74	26.24	29.86	.60
08H05-304	3/8"	1/2"	4	Green	100	F	500'	23.09	24.74	26.24	29.86	.60
08H05-305	3/8"	1/2"	5	Yellow	100	F	500'	23.09	24.74	26.24	29.86	.60
08H05-306	3/8"	1/2"	6	Orange	100	F	500'	23.09	24.74	26.24	29.86	.60
08H05-307	3/8"	1/2"	7	Gold	100	F	500'	23.09	24.74	26.24	29.86	.60
08H05-308	3/8"	1/2"	8	White	100	F	500'	23.09	24.74	26.24	29.86	.60
08H05-309	3/8"	1/2"	9	Pink	100	F	500'	23.09	24.74	26.24	29.86	.60
08H05-310	3/8"	1/2"	10	Purple	100	F	500'	23.09	24.74	26.24	29.86	.60
08H05-311	3/8"	1/2"	11	Black	100	F	500'	23.09	24.74	26.24	29.86	.60
08H05-312	3/8"	1/2"	12	Red	100	F	500'	23.09	24.74	26.24	29.86	.60
08H05-313	3/8"	1/2"	13	Green	100	F	500'	23.09	24.74	26.24	29.86	.60
08H05-314	3/8"	1/2"	14	Yellow	100	F	500'	23.09	24.74	26.24	29.86	.60
08H05-315	3/8"	1/2"	15	Orange	100	F	500'	23.09	24.74	26.24	29.86	.60
08H05-316	3/8"	1/2"	16	Gold	100	F	500'	23.09	24.74	26.24	29.86	.60

Accuflex Quality Hose and Tubing

THE RECOGNIZED LEADER IN BEVERAGE TRANSFER PRODUCTS

140° Fahrenheit is the maximum operating temperature for all items listed except for High Temperature Tubing

Drain Tubing

Sani-Clean AM™ Series 218 SPECIAL PROPRIETARY COMPOUND

- Antimicrobial additive discourages the development of fungal growth on the inner and outer surface of tubing
- Unique translucent metallic gray color offers a sanitary appearance, while allowing for a visual inspection of the line
- Flexible and kink resistant

APPROVED BY MAJOR BOTTLERS

DISCOURAGES FUNGAL GROWTH						PRICES PER 100'			PRICE PER FOOT
Catalog No.	I.D.	O.D.	Working Pressure at 70° F	Clamp Index	Roll Size	4 Rolls	2 Rolls	1 Roll	Under 100'
08H05-401	1/2"	3/4"	45	06K07-101	100'	39.24	42.04	44.59	.80
08H05-402	5/8"	7/8"	40	06K07-101	100'	50.93	54.57	57.88	1.00
08H05-403	3/4"	1"	39	06G08-206	100'	56.36	60.39	64.05	1.20
08H05-113	1"	1-1/4"	25	06G08-206	100'	79.04	84.69	89.82	1.60



TigerFlex® Series DHG SMOOTH BORE PVC WITH PVC HELIX REINFORCEMENT

- Convoluted construction provides exceptional kink resistance • Has a very tight bend radius for "hard to install" locations • Ideal where kinking or crushing of tube is an issue

MINIMIZES FLOW RESTRICTIONS						PRICES PER 100'			PRICE PER FOOT
Catalog No.	I.D.	O.D.	Working Pressure at 68° F	Clamp Index	Roll Size	4 Rolls	2 Rolls	1 Roll	Under 100'
08H05-200	1/2"	11/16"	38	-	100'	78.64	84.26	89.36	1.60
08H05-201	3/4"	1-1/16"	36	-	100'	78.64	84.26	89.36	1.60
08H05-202	1"	1-3/8"	36	-	100'	108.91	116.69	123.76	2.00



Outdoor Gas/Beverage Line

Bev-Seal® Series 176 BARRIER PROTECTED, UV RESISTANT CO₂ SUPPLY HOSE

NO FLAVOR CONTAMINATION

- Unique Duo-Ex WHITE over BLACK outer jackets provide superior UV resistance and outdoor service life.
- Proprietary Barrier Protected core tube design resists permeation of the CO₂ gas, while at the same time protecting the gas from ingress of external contaminants • FDA compliant inner material
- Superior bend radius • NSF certified

IDEAL FOR OUTDOOR GAS LINES						PRICES PER 100'			PRICE PER FOOT
Catalog No.	I.D.	O.D.	Working Pressure at 70° F	Clamp Index	Roll Size	4 Rolls	2 Rolls	1 Roll	Under 100'
08H05-255	1/4"	15/32"	300	-	500'	30.73	32.59	37.09	.70
08H05-256	3/8"	19/32"	300	-	300'	44.04	46.71	53.16	.99



High Temperature Tubing

Silcon® Silicone Tubing MANUFACTURED BY NEW AGE® INDUSTRIES

HIGH TEMPERATURE

- Able to withstand extreme temperature variations from -100°F to 500°F • Odorless, tasteless and inert
- Translucent natural color for visual contact with flow of product • Made from FDA sanctioned ingredients
- Excellent bend radius permits installation into restricted spaces without impeding flow • NSF certified

IDEAL FOR LOW PRESSURE APPLICATIONS						PRICES PER 100'			PRICE PER FOOT
Catalog No.	I.D.	O.D.	Working Pressure at 70° F	Clamp Index	Roll Size	4 Rolls	2 Rolls	1 Roll	Under 100'
08S01-101	5/16"	1/2"	10	-	100'	91.85	96.81	99.50	1.12
08S01-102	3/8"	5/8"	10	-	100'	134.10	141.35	145.28	1.64
08S01-103	1/2"	3/4"	10	-	100'	168.94	178.07	183.02	1.94



Tubing (Soda Related)

Accuflex Bev-Seal Ultra® Tubing Bundles

Bev-Seal Ultra® Series 974 CABLED BARRIER TUBING BUNDLE

**FLUSHABLE
TASTE BARRIER**

- Tubes are Bev-Seal Ultra® Series 235, each color coded, numbered and branded with NSF markings
- Date coded for traceability
- Special film wrap over tubes offers excellent flexibility and tight bend capabilities
- Silver-gray jacket coated with slip agent to minimize friction
- Jacket is branded with NSF marks, sequential footage markings and product I.D. • **APPROVED BY MAJOR BOTTLERS**



SOLD IN FULL ROLLS ONLY — 100' ROLLS STOCKED



PREVENTS FLAVOR PERMEATION						PRICES PER 100'		
# of Lines	Configuration	OD	100' Roll Catalog No.	200' Roll Catalog No.	500' Roll Catalog No.	100' ROLL PRICING		
						4 Rolls	2 Rolls	1 Roll
8	7pc 1/4" 1pc 3/8"	1.5	08H05-168	08H05-175	08H05-176	263.76	274.31	281.82
8	8pc 3/8"	2.0	08H05-173	08H05-182	08H05-183	278.63	289.77	297.71
10	8pc 1/4" 2pc 3/8"	1.7	08H05-170	08H05-177	08H05-178	266.18	276.83	284.41
10	10pc 3/8"	2.2	08H05-185	08H05-186	08H05-187	324.12	337.08	346.32
12	8pc 1/4" 4pc 3/8"	2.0	08H05-172	08H05-179	08H05-180	303.78	315.93	324.59
12	12pc 3/8"	2.2	08H05-188	08H05-191	08H05-189	347.22	361.11	371.00
14	10pc 1/4" 4pc 3/8"	2.2	08H05-184	08H05-190	08H05-192	335.67	349.09	358.66
14	14pc 3/8"	2.6	08H05-174	08H05-193	08H05-181	419.56	436.35	448.30
16	16pc 3/8"	3.0	08H05-195	08H05-196	08H05-194	462.33	479.66	491.96

Ratcheting Bundle Cutter

PERFECT FOR CUTTING BUNDLES UP TO 2-1/2" DIA.

When used properly and blades kept sharp, the ratcheting bundle cutter will produce clean and square cuts



20H05-102 **\$29.95**

Jacket Slicer for Bundles

EASILY SPLITS JACKET FOR ACCESS TO TUBES

Easily slides in from the end between tubes and bundle jacket



20H05-101 **\$16.95**

Stainless Steel Stepless Clamps

STEPLESS® . . . WHEN NOTHING LESS THAN A PERFECT SEAL WILL DO

- Manufactured of 304 grade stainless steel for extended durability and increased corrosion resistance
- Stepless® tongue-in-groove design provides uniform pressure and gapless leak-free seal
- All Oetiker® clamps have burr-free edges to protect parts and to prevent injury during assembly
- The clamp ears adjustable crimp range compensates for component tolerances and applied pressure



HOW TO ORDER CLAMPS AND FERRULES TO PROPERLY FIT HOSE: Selecting the correct clamp is similar to fitting a ring on your finger. There should be sufficient "play" to get the clamp on and off the hose with ease. For softer vinyl hoses, the hose should be placed on the fitting before selecting a clamp size.

Catalog No.	Oetiker No.	Range Closed-Open	Clamp Index	Prices per bags of 100 pc			Price Each	Catalog No.	Oetiker No.	Range Closed-Open	Clamp Index	Prices per bags of 100 pc			Price Each
				500+	300+	100+						500+	300+	100+	
06G08-219	6.5	.209 - .256	-	23.14	23.82	24.55	.45	06G08-209	24.1	.823 - .949	-	12.86	13.24	13.64	.25
06G08-212	7.0	.228 - .276	-	12.86	13.24	13.64	.25	06G08-202	25.6	.882 - 1.008	-	15.09	15.53	16.00	.35
06G08-187	8.0	.268 - .315	-	12.86	13.24	13.64	.25	06G08-199	27.1	.941 - 1.067	-	12.86	13.24	13.64	.25
06G08-188	8.7	.276 - .343	A	12.86	13.24	13.64	.25	06G08-200	28.6	1.00 - 1.126	P	12.86	13.24	13.64	.25
06G08-189	9.5	.307 - .374	-	12.86	13.24	13.64	.25	06G08-197	30.1	1.06 - 1.185	-	12.86	13.24	13.64	.25
06G08-198	10.0	.327 - .394	-	12.86	13.24	13.64	.25	06G08-220	31.6	1.12 - 1.244	-	31.29	32.21	33.18	.60
06G08-205	10.5	.346 - .413	B	12.86	13.24	13.64	.25	06G08-221	33.1	1.18 - 1.303	-	31.71	32.65	33.64	.60
06G08-190	11.3	.378 - .445	D	12.86	13.24	13.64	.25	06G08-222	34.6	1.24 - 1.362	-	32.00	32.94	33.94	.60
06G08-207	11.8	.398 - .465	-	12.86	13.24	13.64	.25	06G08-210	36.1	1.30 - 1.421	-	32.57	33.53	34.55	.45
06G08-184	12.3	.386 - .484	C	12.86	13.24	13.64	.25	06G08-223	37.6	1.35 - 1.480	-	33.14	34.12	35.15	.65
06G08-181	12.8	.406 - .504	-	12.86	13.24	13.64	.25	06G08-211	38.1	1.37 - 1.500	-	33.57	34.56	35.61	.47
06G08-185	13.3	.425 - .524	E	12.86	13.24	13.64	.25	06G08-213	39.6	1.43 - 1.559	-	34.00	35.00	36.06	.60
06G08-191	14.0	.453 - .551	F	12.86	13.24	13.64	.25	06G08-216	41.0	1.49 - 1.614	-	34.29	35.29	36.36	.60
06G08-192	14.5	.472 - .571	Q	12.86	13.24	13.64	.25	06G08-217	42.5	1.55 - 1.673	-	34.71	35.74	36.82	.60
06G08-214	15.3	.504 - .602	-	12.86	13.24	13.64	.25	06G08-224	44.0	1.61 - 1.732	-	35.29	36.32	37.42	.65
06G08-193	15.7	.520 - .618	G	12.86	13.24	13.64	.25	06G08-218	45.5	1.67 - 1.791	-	35.57	36.62	37.73	.65
06G08-203	16.2	.539 - .638	M	12.86	13.24	13.64	.25	06G08-225	47.0	1.72 - 1.850	-	36.14	37.21	38.33	.70
06G08-183	17.0	.571 - .669	H	12.86	13.24	13.64	.25	06G08-226	48.5	1.78 - 1.909	-	36.43	37.50	38.64	.70
06G08-215	17.5	.591 - .689	-	26.07	26.84	27.65	.40	06G08-227	50.0	1.84 - 1.969	-	36.86	37.94	39.09	.80
06G08-194	18.5	.602 - .728	J	12.86	13.24	13.64	.25	06G08-228	51.5	1.90 - 2.028	-	37.29	38.38	39.55	.70
06G08-195	19.8	.654 - .780	K	12.86	13.24	13.64	.25	06G08-229	52.2	1.93 - 2.055	-	37.71	38.82	40.00	.70
06G08-201	21.0	.701 - .827	I	12.86	13.24	13.64	.25	06G08-230	53.0	1.96 - 2.087	-	37.71	38.82	40.00	.70
06G08-196	22.6	.764 - .890	L	12.86	13.24	13.64	.25	06G08-231	54.5	2.02 - 2.146	-	38.14	39.26	40.45	.70
06G08-208	23.5	.799 - .925	-	29.29	30.15	31.06	.41	06G08-232	56.0	2.08 - 2.205	-	38.43	39.56	40.76	.70

Oetiker Clamps

One-Ear Stainless Steel Clamps

One-Ear Zinc Plated Clamps

OETIKER® – A GLOBAL LEADER IN CLAMPING SOLUTIONS

- Manufactured of 304 grade stainless steel for extended durability and increased corrosion resistance
- All Oetiker® clamps have burr-free edges to protect parts and to prevent injury during assembly
- The clamp ears adjustable crimp range compensates for component tolerances and applied pressure



- Manufactured cold rolled steel and zinc plated to improve durability and increase corrosion resistance
- All Oetiker® clamps have burr-free edges to protect parts and to prevent injury during assembly
- The clamp ears adjustable crimp range compensates for component tolerances and applied pressure



Catalog No.	Oetiker No.	Range Closed-Open	Clamp Index	Prices per bags of 100 pc			Price Each
				500+	300+	100+	
06G08-165	105	.350 - .413	B	11.43	11.76	12.12	.20
06G08-167	113	.382 - .445	D	11.57	11.91	12.27	.20
06G08-138	123	.409 - .484	C	11.86	12.21	12.58	.21
06G08-140	133	.449 - .524	E	11.86	12.21	12.58	.21
06G08-168	140	.469 - .551	F	12.00	12.35	12.73	.22
06G08-143	145	.496 - .571	-	12.14	12.50	12.88	.22
06G08-169	157	.543 - .618	G	12.43	12.79	13.18	.22
06G08-170	170	.595 - .669	H	12.71	13.09	13.48	.23
06G08-171	185	.618 - .728	-	12.86	13.24	13.64	.23
06G08-179	198	.669 - .780	K	13.29	13.68	14.09	.24
06G08-180	210	.717 - .827	-	13.86	14.26	14.70	.25

Catalog No.	Oetiker No.	Range Closed-Open	Clamp Index	Prices per bags of 100 pc			Price Each
				500+	300+	100+	
06G08-134	105	.350 - .413	B	9.57	9.85	10.15	.17
06G08-137	123	.409 - .484	C	10.14	10.44	10.76	.18
06G08-139	133	.449 - .524	E	10.14	10.44	10.76	.18
06G08-141	140	.469 - .551	F	10.14	10.44	10.76	.18
06G08-142	145	.496 - .571	-	10.14	10.44	10.76	.18
06G08-144	157	.531 - .618	G	10.14	10.44	10.76	.18
06G08-146	170	.594 - .669	H	10.14	10.44	10.76	.18
06G08-147	185	.618 - .728	-	10.14	10.44	10.76	.18
06G08-148	198	.669 - .780	K	10.29	10.59	10.91	.19

OTHER CLAMPS AVAILABLE UPON REQUEST

Two-Ear Stainless Steel Clamps Two-Ear Zinc Plated Clamps

OETIKER® – A GLOBAL LEADER IN CLAMPING SOLUTIONS



- Manufactured of 304 grade stainless steel for extended durability and increased corrosion resistance
- All Oetiker® clamps have burr-free edges to protect parts and to prevent injury during assembly
- The clamp ears adjustable crimp range compensates for component tolerances and applied pressure



- Manufactured cold rolled steel and zinc plated to improve durability and increase corrosion resistance
- All Oetiker® clamps have burr-free edges to protect parts and to prevent injury during assembly
- The clamp ears adjustable crimp range compensates for component tolerances and applied pressure

Catalog No.	Oetiker No.	Range Closed-Open	Clamp Index	Prices per bags of 100 pc			Price Each
				500+	300+	100+	
06G08-111	0507R	.197 - .276	-	26.29	27.06	27.88	.47
06G08-113	0709R	.276 - .354	A	27.43	28.24	29.09	.49
06G08-174	0811R	.315 - .433	B	27.57	28.38	29.24	.49
06G08-176	1113R	.433 - .512	C	29.43	30.29	31.21	.53
06G08-164	1315R	.492 - .591	F	30.57	31.47	32.42	.55
06G08-177	1517R	.551 - .669	G	34.00	35.00	36.06	.61
06G08-178	1518R	.591 - .709	H	36.14	37.21	38.33	.64

Catalog No.	Oetiker No.	Range Closed-Open	Clamp Index	Prices per bags of 100 pc			Price Each
				500+	300+	100+	
06G08-110	0507	.197 - .296	-	20.86	21.47	22.12	.36
06G08-112	0709	.276 - .354	A	20.86	21.47	22.12	.36
06G08-114	0811	.319 - .433	B	20.86	21.47	22.12	.36
06G08-120	1113	.425 - .512	C	21.29	21.91	22.58	.36
06G08-121	1315	.492 - .591	F	22.71	23.38	24.09	.40
06G08-122	1517	.551 - .669	G	23.00	23.68	24.39	.40
06G08-123	1518	.591 - .709	H	23.00	23.68	24.39	.40
06G08-124	1720	.638 - .787	K	25.00	25.74	26.52	.44
06G08-125	1922	.709 - .866	I	45.43	46.76	48.18	.63
06G08-127	2023	.748 - .906	L	28.71	29.56	30.45	.50
06G08-128	2327	.886 - 1.063	N	34.00	35.00	36.06	.59
06G08-129	2528	.945 - 1.102	P	36.14	37.21	38.33	.63
06G08-132	3134	1.15 - 1.339	-	60.00	61.76	63.64	.99



Large Diameter Adjustable Clamp

MADE FROM 300 SERIES STAINLESS STEEL

Catalog No.	Range Open - Closed	300+	100+	50+	Each
06G08-206	1.00 - 1.625	0.88	0.92	0.94	0.98

OTHER CLAMPS AVAILABLE UPON REQUEST – CONTACT YOUR SALES REPRESENTATIVE

Adjustable Worm-Gear Clamps – 300 Series Stainless Steel

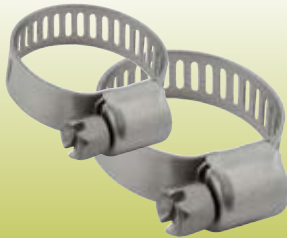

Economy

A HIGH QUALITY IMPORT
OFFERING AN ALTERNATIVE
TO MORE EXPENSIVE CLAMPS
Burr-free edges • Durable • Strong

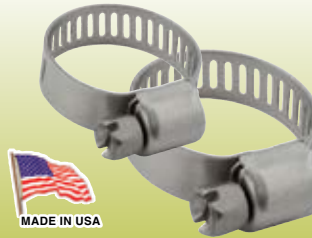

IDEAL

A LONG TRUSTED
LEADING MANUFACTURER OF
WORM-GEAR CLAMPS
Burr-free edges • Durable • Strong

Catalog No.	Range Open - Closed	500+	300+	100+	Each
06E07-203	1/4" - 5/8"	0.21	0.22	0.25	0.35
06E07-201	3/8" - 7/8"	0.22	0.23	0.25	0.35

Catalog No.	Range Open - Closed	500+	300+	100+	Each
06K07-103	1/4" - 5/8"	0.40	0.43	0.45	0.55
06K07-101	3/8" - 7/8"	0.42	0.44	0.46	0.57

Additional price breaks available on most items. Login to your website account or contact your sales representative for pricing.



Oetiker® Clamp Field Kits

AVAILABLE KITS: STEPLESS® • 1-EAR • 2-EAR

ALL KITS INCLUDE ONE PAIR OF OETIKER SIDE-JAW PINCERS

Catalog No.	Description	5+	2+	Each
06D03-196	STEPLESS CLAMP KIT CONTAINS 25 each clamp size: 11/32", 13/32", 15/32", 75.95 1/2", 35/64", 9/16", 5/8", 11/16", 23/32"	64.95	67.95	70.95
06G08-173	ONE EAR CLAMP KIT CONTAINS 25 each clamp size: 3/8", 27/64", 15/32", 1/2", 35/64", 9/16", 5/8" 11/16," 23/32"	60.95	63.95	66.95
06G08-155	TWO EAR CLAMP KIT CONTAINS 25 each clamp size: 1/4", 5/16", 3/8", 1/2", 9/16", 19/32", 5/8", and 3/4"	80.95	83.95	87.95

Oetiker® Brand Pincers



STANDARD JAW
20G08-120
 10+ **\$14.95**
 5+ \$15.95 Ea. \$16.95



SIDE JAW
20G08-119
 10+ **\$20.95**
 5+ \$21.95 Ea. \$22.95



STANDARD JAW
20G08-124
 10+ **\$29.95**
 5+ \$30.95 Ea. \$31.95



SIDE JAW
20G08-125
 10+ **\$29.95**
 5+ 30.95 Ea. \$32.95

Standard Jaw Pincers



**RUGGED
 AND
 DEPENDABLE**



20K08-100 10+ **\$6.50** 5+ \$6.95 Ea. \$7.50

Pinch-Off Tubing Tool

- Rounded jaws prevent plastic tubing damage
- Allows work to be performed without shutting down system
- Reduces service call time



20R09-120

10+ **\$18.50** 5+ \$18.95 Ea. \$19.95

Additional price breaks available on most items. Login to your website account or contact your sales representative for pricing.

Flat-Blade Tubing and Hose Cutters



MODEL 100
 Cuts up to 1" dia.



MODEL 100-OT
 Cuts up to 1" dia.

SPRING
 LOADED



MODEL 200
 Cuts up to 2" dia.

Catalog No.	Description	10+	5+	Each
20L02-103	Model 100	12.95	13.95	14.95
20L02-104	Blade only	4.73	5.08	5.40

Catalog No.	Description	10+	5+	Each
20L02-105	Model 100-OT	15.95	16.95	17.95
20L02-104	Blade only	4.73	5.08	5.40

Catalog No.	Description	10+	5+	Each
20L02-107	Model 200	15.95	16.95	17.95
20L02-108	Blade only	5.88	6.22	6.70

Spear-Point Tubing and Hose Cutters



SNIP
 CUTS
 1/8" OD to 3/4" OD



CUTS
 1/8" OD to 3/4" OD



Catalog No.	Description	6+	3+	Each
20L02-120	Cutter	23.95	24.95	26.95
20L02-121	Blade only	5.25	5.50	5.75

Catalog No.	Description	25+	10+	Each
20L02-101	Cutter	7.95	8.50	8.95
20L02-102	Blade only	1.80	1.90	2.00

Catalog No.	Description	25+	10+	Each
20K02-101	Cutter	2.45	2.55	2.95
20K02-102	Blade only	1.35	1.45	1.65

Premium Vinyl Tapes

HIGH QUALITY VINYL TAPE WITH EXCELLENT ADHESION



20D01-106 is great for finishing exterior of insulated tubing bundles. Helps protect insulation and reduces friction when pulling through a chase.

- 2" wide x 100' length per roll

20D01-107 is a cold temperature tape that remains stretchy and pliable even in cold environments and is great for using as a moisture barrier on insulated tubing bundles.

- 2" wide x 100' length per roll

Catalog No.	Size	6+	3+	Ea.
20D01-106	2" Wide Vinyl Tape	4.75	5.00	5.25
20D01-107	2" Wide Cold Temp. Tape	5.00	5.25	5.50

Aluminum Foil Tapes

SUPERIOR ADHESION AND VIRTUALLY NO ODOR



20A01-103 is great for transferring cold from glycol lines to product lines on insulated tubing bundles.

- 2" wide x 150' length per roll

20A01-104 is the same as above and used for the same purpose, but requires fewer turns per foot when wrapping insulated tubing bundles.

- 3" wide x 150' length per roll

Catalog No.	Size	6+	3+	Each
20A01-103	2" Wide Foil Tape	11.95	12.50	12.95
20A01-104	3" Wide Foil Tape	16.95	17.95	18.95

Premium Cloth Duct Tape

HIGH QUALITY TAPE WITH EXCELLENT ADHESION



Tough polyethylene with fabric reinforcement provides superior adhesion and is used for the initial phase of wrapping lines in insulated tubing bundles. It has many other uses as well.

- 2" wide x 180' length per roll

Catalog No.	Size	6+	3+	Each
20D01-100	2" Wide Duct Tape (black)	8.50	8.95	9.50
20D01-101	2" Wide Duct Tape (gray)	7.50	7.95	8.50

Adhesive Foam Insulation Tape

HIGH QUALITY TAPE WITH EXCELLENT ADHESION



Self adhesive, easily molds to irregular surfaces. Insulated and prevents sweating.

- 1/8" thick x 2" wide x 30' length per roll

Catalog No.	24+	12+	Each
20D01-104	6.95	7.50	7.95

Self-Locking Cable Ties



Heavy duty nylon with positive lock and non-slip.



Ref. #	Catalog No.	Description	1000+	500+	Each
1	14Q02-112	5.5" Standard (Black)	0.04	0.05	0.06
1	14Q02-104	7.5" Standard (Natural)	0.05	0.06	0.07
1	14Q02-110	7.5" Standard (Black)	0.06	0.07	0.10
1	14Q02-102	15" Standard (Natural)	0.13	0.14	0.18
1	14Q02-108	15" Standard (Black)	0.14	0.15	0.20
1	14Q02-113	36" Standard (Black)	0.28	0.30	0.41
2	14Q02-105	7.5" Screw Mount (Natural)	0.10	0.11	0.13
2	14Q02-111	7.5" Screw Mount (Black)	0.11	0.12	0.15
2	14Q02-101	14.5" Screw Mount (Natural)	0.28	0.30	0.40
2	14Q02-107	14.5" Screw Mount (Black)	0.36	0.38	0.50

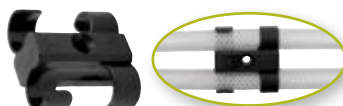

T-Clip Fasteners

For fast, easy securing of tubing. Makes dual runs look great!

Catalog No.	Mfg. No.	Holding Range O.D.	50+	25+	Each
14103-110	T-10	3/8" - 1/2"	0.38	0.41	0.43
14103-112	T-12	1/2" - 5/8"	0.42	0.45	0.47
14103-115	T-15	5/8" - 3/4"	0.62	0.65	0.69

Additional price breaks available on most items. Login to your website account or contact your sales representative for pricing.



Armaflex® Foam Tube Insulation

MILDEW AND MOLD RESISTANT

Great for insulating soda/beer tubing runs

PRICED PER FOOT - SOLD IN SIX FOOT SECTIONS

Catalog No.	Wall	ID	36'+	18'+	6'+
19D05-106	1/2"	4-1/8"	3.40	3.61	3.79
19D05-109	1/2"	4-1/2"	3.74	3.97	4.16
19D05-118	3/4"	1-3/8"	1.82	1.94	2.03
19D05-107	3/4"	1-5/8"	2.46	2.61	2.74
19D05-112	3/4"	2-1/8"	3.03	3.22	3.38
19D05-120	3/4"	2-1/2"	3.27	3.47	3.64
19D05-116	3/4"	2-5/8"	3.82	4.06	4.26
19D05-121	3/4"	3-1/8"	3.78	4.02	4.21
19D05-117	1"	1-5/8"	3.97	4.22	4.43
19D05-115	1"	2-1/8"	4.90	5.20	5.46

Catalog No.	Wall	ID	36'+	18'+	6'+
19D05-108	1/4"	1/2"	0.40	0.42	0.44
19D05-119	3/8"	1/2"	0.40	0.42	0.44
19D05-103	3/8"	5/8"	0.46	0.48	0.51
19D05-104	3/8"	1-5/8"	0.77	0.82	0.86
19D05-113	1/2"	1-1/8"	0.82	0.88	0.92
19D05-111	1/2"	1-5/8"	1.13	1.20	1.26
19D05-101	1/2"	2-1/8"	1.47	1.56	1.64
19D05-102	1/2"	2-5/8"	2.00	2.13	2.23
19D05-105	1/2"	3-1/8"	2.35	2.50	2.62
19D05-110	1/2"	3-1/2"	2.52	2.67	2.80



Chrome Plated Brass Ball Valves (1/4 Turn)



Ref.#	Catalog No.	Description	100+	50+	25+	Each
1	05B01-346	1/4B x 1/4B Lead Free	4.25	4.50	4.95	5.50
1	05B01-347	3/8B x 3/8B Lead Free	4.60	4.85	5.15	5.50
2	05B01-341	1/4MPT x 1/4B (w/check)	3.95	4.25	4.50	4.95
2	05B01-337	1/4MPT x 3/8B	3.50	3.95	4.50	4.95
2	05B01-342	1/4MPT x 3/8B (w/check)	4.00	4.30	4.60	4.95
3	05B01-344	1/4MPT x 1/4MFL	3.75	3.95	4.50	4.95

Ref.#	Catalog No.	Description	100+	25+	10+	Each
3	05B01-343	1/4MPT x 1/4MFL (w/check)	3.75	3.95	4.50	4.95
4	05B01-317	1/8MPT x 1/8FPT	3.14	3.33	3.53	3.71
4	05B01-321	1/4MPT x 1/4FPT	2.98	3.16	3.36	3.52
4	05B01-322	3/8MPT x 3/8FPT	2.80	2.96	3.15	3.30
4	05B01-323	1/2MPT x 1/2FPT	3.35	3.55	3.77	3.96
5	05B01-319	1/4FPT x 1/4FPT	2.98	3.16	3.36	3.52

Plastic (PVC) Ball Valves (1/4 Turn)



Ref.#	Catalog No.	Description	100+	25+	10+	Each
1	05C07-130	1/4B x 1/4B	5.25	5.50	5.75	5.95
1	05C07-131	3/8B x 3/8B	5.25	5.50	5.75	5.95
1	05C07-132	1/2B x 1/2B	5.25	5.50	5.75	5.95

Ref.#	Catalog No.	Description	100+	25+	10+	Each
2	05C07-133	1/4FPT x 1/4FPT	5.25	5.50	5.75	6.95
3	05C07-134	1/4FPT x 1/4MPT	5.25	5.50	5.75	5.95
4	05C07-135	1/4MPT x 1/4MPT	5.25	5.50	5.75	5.95

Stainless Steel Ball Valves (1/4 Turn)



Ref.#	Catalog No.	Description	25+	10+	Each
1	04C07-116	1/4FPT x 1/4FPT	14.50	14.95	15.95
2	04C07-117	3/8FPT x 3/8FPT	14.95	15.50	15.95
3	04C07-118	1/2FPT x 1/2FPT	15.95	16.95	17.95
4	04C07-119	3/4FPT x 3/4FPT	18.95	19.95	20.95

- 1000 psi 2 pc full port stainless steel valve
- Pure Teflon seats and seals
- Temperature range: -60° to 450F
- 100% leak tested at 100 psi air under water
- Valves will accept a pad-lock on the handle

1" FPT
AVAILABLE UPON
REQUEST

Additional price breaks available on most items. Login to your website account or contact your sales representative for pricing.

Brass Needle Valves (Precise Regulation of Flow)



Ref.#	Catalog No.	Description	25+	10+	Each
1	05B01-132	1/4C x 1/4C	3.05	3.25	3.40
1	05B01-147	3/8C x 3/8C	2.05	2.25	2.50
2	05B01-224	1/4MFL x 1/4MPT	5.95	6.50	6.95

Ref.#	Catalog No.	Description	25+	10+	Each
3	05B01-136	1/4MFL x 1/4MFL	1.95	2.05	2.15
3	05B01-148	3/8MFL x 3/8MFL	5.66	6.01	6.31

Stainless Steel Needle Valves (Precise Regulation of Flow)



Ref.#	Catalog No.	Description	Each
1	04C03-179	1/4MFL x 1/4MPT	10.48
2	04C03-180	1/4MFL x 1/4MFL	10.48

Ref.#	Catalog No.	Description	Each
3	04C03-181	1/4MFL x 1/4FFL CLOSEOUT	10.95
4	04C03-182	1/4MFL x 1/4FFL (Swivel nut)	10.81

Brass 45° Flare Fittings



Plug
MALE FLARE THREAD

Catalog No.	Size	100+	50+	25+	Each
05B01-197	1/4	0.23	0.25	0.27	0.30
05B01-198	3/8	0.70	0.74	0.78	0.85
05B01-236	1/2	1.09	1.16	1.22	1.32



Cap
FEMALE FLARE THREAD

Catalog No.	Size	100+	50+	25+	Each
05B01-199	1/4	0.31	0.33	0.34	0.38
05B01-200	3/8	0.56	0.59	0.62	0.68
05B01-237	1/2	0.65	0.70	0.75	0.80



Nut
FEMALE FLARE THREAD

Catalog No.	Size	100+	50+	25+	Each
05B01-201	1/4	0.35	0.40	0.45	0.50
05B01-202	3/8	0.66	0.70	0.74	0.80
05B01-203	1/2	0.78	0.83	0.87	0.95



Copper Gasket
OUTSIDE TUBE DIAMETER

Catalog No.	Size	100+	50+	25+	Each
05B01-204	1/4	0.18	0.19	0.20	0.22
05B01-205	3/8	0.25	0.27	0.28	0.30
05B01-238	1/2	0.35	0.38	0.39	0.43



Reducing Tee
MALE FLARE THREAD

Catalog No.	Size			100+	50+	25+	Each
	1	2	3				
05B01-174	1/4	1/4	3/8	2.94	3.13	3.28	3.57
05B01-241	3/8	3/8	1/4	3.13	3.31	3.52	3.69
05B01-176	3/8	3/8	1/4	3.01	3.19	3.39	3.55
05B01-175	3/8	1/4	3/8	3.11	3.30	3.50	3.68



Male Run Tee
MALE FLARE THREAD TO MALE PIPE THREAD

Catalog No.	Size		100+	50+	25+	Each
	1	2				
05B01-206	1/4	1/8	1.96	2.08	2.18	2.38
05B01-312	1/4	1/4	2.35	2.50	2.62	2.86
05B01-207	1/4	3/8	3.10	3.25	3.45	3.65
05B01-208	3/8	3/8	3.10	3.27	3.50	3.65



Tee
MALE FLARE THREAD

Catalog No.	Size	100+	50+	25+	Each
05B01-178	1/4	1.55	1.65	1.75	1.85
05B01-177	3/8	1.35	1.55	1.75	1.95
05B01-240	1/2	1.75	2.00	2.25	2.75



Union
MALE FLARE THREAD TO MALE FLARE THREAD

Catalog No.	Size	100+	50+	25+	Each
05B01-169	1/4	0.55	0.58	0.61	0.66
05B01-170	3/8	1.05	1.15	1.25	1.35
05B01-171	1/2	1.63	1.73	1.82	1.98
	1 2				
05B01-168	3/8 x 1/4	1.05	1.10	1.15	1.25
05B01-239	1/2 x 3/8	1.25	1.35	1.45	1.55



Male Half Union
MALE FLARE THREAD TO MALE PIPE THREAD

Catalog No.	Size		100+	50+	25+	Each
	1	2				
05B01-228	1/4	1/8	0.33	0.35	0.37	0.39
05B01-183	1/4	1/4	0.55	0.60	0.65	0.70
05B01-184	1/4	3/8	1.02	1.09	1.14	1.24
05B01-185	1/4	1/2	1.62	1.72	1.81	1.97
05B01-186	3/8	1/4	0.90	0.95	1.00	1.10
05B01-187	3/8	3/8	1.03	1.10	1.15	1.26
05B01-233	3/8	1/2	1.05	1.15	1.25	1.35
05B01-188	1/2	3/8	1.36	1.44	1.51	1.65
05B01-189	3/8	3/4	2.37	2.52	2.64	2.88
05B01-310	1/2	1/2	1.48	1.57	1.65	1.80
05B01-190	1/2	3/4	2.35	2.50	2.62	2.86

Additional price breaks available on most items. Login to your website account or contact your sales representative for pricing.



Male Elbow
MALE FLARE THREAD TO MALE PIPE THREAD

Catalog No.	Size		100+	50+	25+	Each
	1	2				
05B01-306	1/4	1/8	0.69	0.73	0.76	0.83
05B01-191	1/4	1/4	1.15	1.25	1.35	1.45
05B01-243	1/4	3/8	1.65	1.75	1.95	2.25
05B01-192	3/8	1/4	1.10	1.20	1.30	1.40
05B01-193	3/8	3/8	1.27	1.35	1.42	1.55
05B01-194	3/8	1/2	2.18	2.32	2.43	2.65
05B01-195	1/2	3/8	1.68	1.78	1.87	2.05
05B01-210	1/2	1/2	1.68	1.78	1.87	2.05
05B01-313	1/2	3/4	3.75	3.95	4.25	4.50



Cross
MALE FLARE THREAD

Catalog No.	Size	100+	50+	25+	Each
05B01-209	1/4	4.90	5.20	5.50	5.80
05B01-245	3/8	4.22	4.47	4.75	4.98
05B01-246	1/2	5.81	6.15	6.53	6.85



Female Coupling
MALE FLARE THREAD TO FEMALE PIPE THREAD

Catalog No.	Size		100+	50+	25+	Each
	1	2				
05B01-180	1/4	1/4	0.70	0.74	0.78	0.85
05B01-181	1/4	3/8	1.03	1.10	1.15	1.26
05B01-182	3/8	3/8	1.26	1.34	1.40	1.53
05B01-235	3/8	1/2	1.47	1.56	1.64	1.78
05B01-242	1/2	3/4	1.30	1.40	1.50	1.75



Swivel Elbow
MALE FLARE THREAD TO FEMALE FLARE SWIVEL

Catalog No.	Size		100+	50+	25+	Each
	1	2				
05B01-248	1/4	1/4	5.11	5.41	5.75	6.03
05B01-217	3/8	3/8	8.50	8.95	9.50	9.95
05B01-250	1/2	1/2	12.50	13.50	14.50	16.50



Swivel
FEMALE FLARE THREAD

Catalog No.	Size	100+	50+	25+	Each
05B01-215	1/4	1.42	1.51	1.58	1.73
05B01-172	3/8	4.95	5.25	5.55	5.85
05B01-216	3/8	1.82	1.93	2.03	2.21
05B01-247	1/2	2.22	2.35	2.50	2.62



Flare Reducer
MALE FLARE THREAD TO FEMALE FLARE THREAD

Catalog No.	Size		100+	50+	25+	Each
	1	2				
05B01-219	3/8	1/4	1.75	1.86	1.95	2.13
05B01-213	1/4	3/8	1.27	1.35	1.45	1.55
05B01-244	3/8	1/2	2.07	2.20	2.31	2.51

Brass Pipe Fittings



Left Hand to Right Hand

HEX NIPPLE
MALE PIPE THREAD

Catalog No.	Size	100+	50+	25+	Each
05C03-101	1/4	2.44	2.58	2.74	2.87



Hex Nipple
MALE PIPE THREAD

Catalog No.	Size	100+	50+	25+	Each
05B01-289	1/8	0.29	0.32	0.35	0.40
05B01-156	1/4	0.56	0.59	0.62	0.68
05B01-157	3/8	0.86	0.91	0.96	1.04
05B01-290	1/2	1.41	1.50	1.57	1.72
05B01-291	3/4	2.35	2.50	2.65	2.95



Close Nipple
MALE PIPE THREAD

Catalog No.	Size	100+	50+	25+	Each
05B01-142	1/8	0.24	0.25	0.27	0.29
05B01-143	1/4	0.38	0.41	0.43	0.46
05B01-144	3/8	0.64	0.68	0.72	0.78
05B01-145	1/2	0.70	0.74	0.78	0.85
05B01-293	3/4	1.58	1.68	1.78	1.87

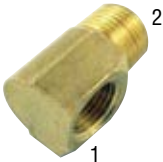

Pipe Street Elbow

MALE PIPE THREAD TO FEMALE PIPE THREAD

Catalog No.	Size		100+	50+	25+	Each
	1	2				
05B01-149	1/8 x 1/8		0.49	0.52	0.55	0.60
05B01-165	1/4 x 1/8		0.90	0.95	1.00	1.10
05B01-150	1/4 x 1/4		1.13	1.20	1.26	1.38
05B01-151	3/8 x 3/8		1.77	1.88	1.97	2.15
05B01-152	1/2 x 1/2		2.76	2.93	3.11	3.26
05B01-287	3/4 x 3/4		5.50	5.95	6.50	6.95



Pipe Coupling

FEMALE PIPE THREAD TO FEMALE PIPE THREAD

Catalog No.	Size	100+	50+	25+	Each
05B01-126	1/8	0.37	0.39	0.41	0.45
05B01-127	1/4	0.55	0.58	0.61	0.66
05B01-285	3/8	0.92	0.98	1.03	1.12
05B01-173	1/2	1.26	1.34	1.41	1.54



Pipe Tee

FEMALE PIPE THREAD

Catalog No.	Size	100+	50+	25+	Each
05B01-105	1/4	2.02	2.14	2.27	2.38
05B01-128	3/8	2.39	2.53	2.69	2.82
05B01-129	1/2	4.75	5.05	5.35	5.65



Countersink Pipe Plug

MALE PIPE THREAD

Catalog No.	Size	100+	50+	25+	Each
05B01-134	1/8	0.32	0.34	0.36	0.39
05B01-135	1/4	0.42	0.45	0.47	0.51
05B01-221	3/8	0.49	0.52	0.55	0.60



Left Hand to Right Hand

MALE PIPE THREAD TO FEMALE PIPE THREAD

Catalog No.	Size	100+	50+	25+	Each
05B01-146	1/4 x 1/4	3.50	3.75	3.95	4.25



Hex Head Pipe Plug

MALE PIPE THREAD

Catalog No.	Size	100+	50+	25+	Each
05B01-153	1/8	0.29	0.31	0.32	0.35
05B01-154	1/4	0.42	0.44	0.46	0.50
05B01-155	3/8	0.63	0.67	0.70	0.77
05B01-300	1/2	1.12	1.19	1.25	1.36
05B01-288	3/4	1.45	1.55	1.65	1.80



Street Pipe Tee

TWO FEMALE PIPE THREADS TO ONE MALE PIPE THREAD

Catalog No.	Size	100+	50+	25+	Each
05B01-163	1/8	0.90	0.95	1.00	1.10
05B01-164	1/4	2.35	2.50	2.65	2.86
05B01-294	3/8	2.64	2.80	2.97	3.12

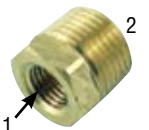

Pipe Bushing

FEMALE PIPE THREAD TO MALE PIPE THREAD

Catalog No.	Size		100+	50+	25+	Each
	1	2				
05B01-138	1/8 x 1/4		0.28	0.30	0.32	0.34
05B01-139	1/4 x 3/8		0.52	0.55	0.58	0.63
05B01-140	1/4 x 1/2		0.95	1.00	1.05	1.15
05B01-141	3/8 x 1/2		0.74	0.78	0.82	0.89
05B01-308	3/8 x 3/4		2.01	2.12	2.26	2.37
05B01-318	1/2 x 3/4		1.38	1.47	1.54	1.68



Male Pipe Reducer

MALE PIPE THREAD TO MALE PIPE THREAD

Catalog No.	Size		100+	50+	25+	Each
	1	2				
05B01-158	1/4 x 1/8		0.55	0.58	0.61	0.66
05C03-102	1/4 x C02		5.48	5.96	6.34	6.65
05B01-159	3/8 x 1/4		0.79	0.84	0.88	0.96
05B01-160	1/2 x 1/4		1.34	1.43	1.50	1.63
05B01-161	1/2 x 3/8		1.58	1.68	1.76	1.92
05B01-292	3/4 x 1/2		1.85	1.95	2.05	2.25



Pipe Reducer

FEMALE PIPE THREAD TO MALE PIPE THREAD

Catalog No.	Size		100+	50+	25+	Each
	1	2				
05B01-162	1/4 x 1/8		0.55	0.58	0.61	0.66
05B01-166	3/8 x 1/4		1.05	1.10	1.15	1.25

SERVICE KIT CONTENTS

- 6 Hose stem 1/4 B x 1/4 MPT
- 6 Hose stem 3/8 B x 3/8 MPT
- 6 Swvl. Nut stem 1/4 B x 1/4 FFL
- 6 Swvl. Nut stem 1/4 B x 3/8 FFL
- 12 Swvl. Nut stem 3/8 B x 3/8 FFL
- 6 Union 3/8 MFL x 1/4 MFL
- 6 Union 1/4 MFL
- 6 Union 3/8 MFL
- 4 Tee 3/8 MFL
- 6 Half Union 1/4 MFL x 1/4 MPT
- 6 Half Union 1/4 MFL x 3/8 MPT
- 6 Half Union 3/8 MFL x 3/8 MPT
- 6 Elbow 3/8 MFL x 3/8 MPT
- 6 Cap 1/4 FFL
- 6 Cap 3/8 FFL
- 6 Nut 1/4 Flare
- 6 Nut 3/8 Flare
- 2 Swvl. Conn. 1/4 FFL x 1/4 FFL
- 2 Swvl. Conn. 3/8 FFL x 3/8 FFL
- 4 Tee Compression 3/8
- 25 Sleeve 3/8 Compression
- 6 Half Union 1/4 MFL x 1/8 MPT
- 4 Half Union 3/8 MFL x 1/2 MPT
- 4 Union Comp. 3/8 x 1/4

Brass Field Service Kit

SATCHEL-STYLE WITH SEE-THRU LID

- 15 removable dividers
- Sturdy co-polymer resin construction
- 15" W x 11 3/4" D x 2 1/2" H

05B01-101
\$159.95



Barbed Hose Adapters



Catalog No.	Size		100+	50+	25+	Each
	1	2				
05B01-102	1/4 x 1/8		0.39	0.41	0.43	0.46
05B01-103	1/4 x 1/4		0.52	0.58	0.61	0.66
05B01-104	1/4 x 3/8		0.70	0.75	0.80	0.85
05B01-334	1/4 x 1/2		1.35	1.40	1.50	1.65
05B01-106	5/16 x 1/4		0.65	0.69	0.72	0.79
05B01-295	5/16 x 3/8		0.85	0.91	0.95	1.04
05B01-227	3/8 x 1/4		0.53	0.56	0.59	0.62
05B01-107	3/8 x 3/8		0.68	0.72	0.75	0.85
05B01-261	3/8 x 1/2		1.41	1.50	1.57	1.72
05B01-229	3/8 x 3/4		2.21	2.35	2.46	2.68
05B01-131	1/2 x 3/8		0.90	0.95	1.00	1.05
05B01-262	1/2 x 1/2		1.25	1.32	1.39	1.51
05B01-249	1/2 x 3/4		1.80	1.90	2.02	2.12
05B01-263	3/4 x 3/4		1.72	1.82	1.94	2.03

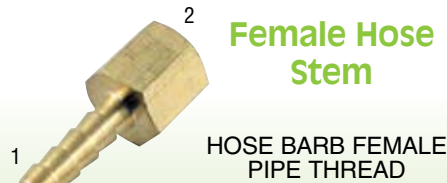

Catalog No.	Size		100+	50+	25+	Each
	1	2				
05B01-109	3/16 x 1/4		0.74	0.78	0.82	0.89
05B01-225	1/4 x 1/4		0.83	0.89	0.93	1.01
05B01-265	3/8 x 1/8		0.78	0.83	0.87	0.95
05B01-226	3/8 x 1/4		0.87	0.92	0.97	1.05
05B01-110	3/8 x 3/8		0.95	1.01	1.06	1.15
05B01-108	1/2 x 3/8		1.05	1.10	1.15	1.25
05B01-218	1/2 x 1/2		1.35	1.45	1.55	1.75

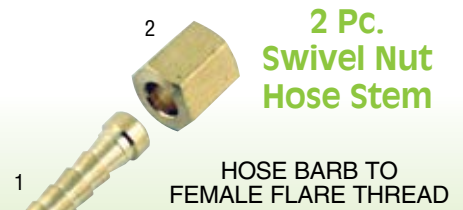

Cat. No.	Size		100+	50+	25+	Each
	1	2				
05B01-117	1/4 x 1/4		0.90	0.95	1.00	1.09
05B01-118	1/4 x 3/8		1.08	1.14	1.20	1.31
05B01-119	3/8 x 3/8		1.34	1.43	1.50	1.63
05B01-120	3/8 x 1/2		2.43	2.57	2.73	2.87
05B01-266	1/2 x 1/2		1.63	1.72	1.83	1.92



Catalog No.	Size		100+	50+	25+	Each
	1	2				
05B01-114	1/4 x 1/4		1.23	1.31	1.37	1.49
05B01-115	1/4 x 3/8		1.20	1.25	1.35	1.45
05B01-116	3/8 x 3/8		1.25	1.30	1.36	1.50
05B01-211	1/2 x 1/2		2.15	2.28	2.42	2.54



Catalog No.	Size	100+	50+	25+	Each
05B01-121	1/4	0.47	0.52	0.55	0.60
05B01-231	5/16	0.57	0.61	0.64	0.70
05B01-122	3/8	0.60	0.64	0.67	0.73
05B01-264	1/2	0.88	0.94	0.98	1.07



Catalog No.	Size		100+	50+	25+	Each
	1	2				
05B01-332	1/4 x 3/8		1.65	1.75	1.86	1.95
05B01-133	3/8 x 1/4		1.25	1.35	1.45	1.55
05B01-137	3/8 x 3/8		1.60	1.70	1.80	1.90
05B01-333	3/8 x 1/2		1.55	1.65	1.75	1.85
05B01-123	1/2 x 3/8		1.62	1.72	1.80	1.96
05B01-212	1/2 x 1/2		1.91	2.03	2.13	2.32

Additional price breaks available on most items. Login to your website account or contact your sales representative for pricing.

Brass Garden Hose Adapters

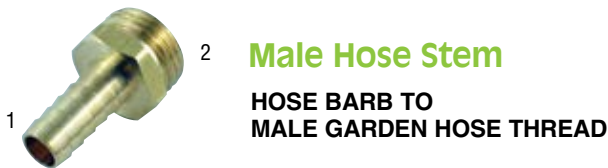

Catalog No.	Size		100+	50+	25+	Each
	1	2				
05B01-267	3/8 x 3/4		1.60	1.70	1.80	1.90
05B01-268	1/2 x 3/4		1.58	1.68	1.76	1.92
05B01-299	5/8 x 3/4		1.64	1.73	1.84	1.93
05B01-269	3/4 x 3/4		1.61	1.71	1.81	1.90

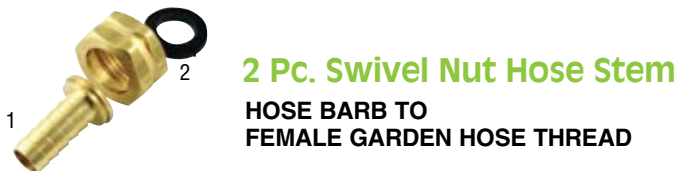

Catalog No.	Size		100+	50+	25+	Each
	1	2				
05B01-111	3/8 x 3/4		1.85	1.95	2.05	2.15
05B01-112	1/2 x 3/4		1.85	1.95	2.05	2.15
05B01-179	5/8 x 3/4		1.80	1.90	2.00	2.15
05B01-113	3/4 x 3/4		2.05	2.15	2.30	2.40



Catalog No.	Size		100+	50+	25+	Each
	1	2				
05B01-296	3/4 x 1/2		1.75	1.86	1.95	2.12
05B01-297	3/4 x 3/4		2.06	2.18	2.32	2.43



Catalog No.	Size		100+	50+	25+	Each
	1	2				
05B01-298	3/8 x 3/4		2.89	3.06	3.25	3.41



Ref. #	Catalog No.	Description	100+	50+	25+	Each
1	05B01-348	Male MGHT	1.52	1.61	1.71	1.79
2	05B01-349	Female FGHT	3.54	3.75	3.98	4.17

Garden Hose Washer 05B01-304 0.10 Ea.

Brass Compression Fittings



Sleeve

Brass or Delrin

Catalog No.	Tube O.D.	100+	50+	25+	Each
05B01-222	1/4-Brass	0.06	0.07	0.08	0.09
05B01-223	3/8-Brass	0.09	0.10	0.11	0.12
05B01-251	1/2-Brass	0.14	0.16	0.18	0.20
05B01-325	1/4-Delrin	0.08	0.10	0.15	0.20
05B01-326	3/8-Delrin	0.15	0.20	0.22	0.25
05B01-327	1/2-Delrin	0.28	0.30	0.31	0.34



Elbow

FEMALE COMPRESSION TO FEMALE COMPRESSION

Catalog No.	Size	100+	50+	25+	Each
05B01-271	1/4	1.15	1.25	1.35	1.55
05B01-272	3/8	1.65	1.75	1.85	1.95
05B01-273	1/2	1.95	2.15	2.35	2.75



Female Connector

FEMALE COMPRESSION FEMALE PIPE THREAD

Catalog No.	Size		100+	50+	25+	Each
	1	2				
05B01-274	3/8 x 1/4		1.35	1.44	1.51	1.64
05B01-275	3/8 x 3/8		1.22	1.30	1.36	1.48
05B01-276	3/8 x 1/2		1.32	1.41	1.48	1.61



Tube Insert

Catalog No.	Tube I.D.	100+	50+	25+	Each
05B01-335	.17	0.15	0.16	0.17	0.18
05B01-328	.25	0.20	0.23	0.26	0.30
05B01-329	.375	0.25	0.30	0.35	0.40



Tee

FEMALE COMPRESSION

Catalog No.	Size			100+	50+	25+	Each
	1	2	3				
05B01-124	1/4 x 1/4 x 1/4			1.45	1.55	1.65	1.95
05B01-125	3/8 x 3/8 x 1/4			2.86	3.03	3.22	3.38
05B01-220	3/8 x 3/8 x 3/8			2.05	2.15	2.25	2.50
05B01-167	1/2 x 1/2 x 1/4			4.25	4.55	4.75	4.95
05B01-255	1/2 x 1/2 x 1/2			3.35	3.55	3.77	3.96

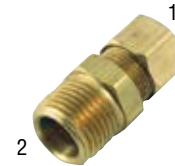

Male Connector

FEMALE COMPRESSION MALE PIPE THREAD

Catalog No.	Size		100+	50+	25+	Each
	1	2				
05B01-277	1/4 x 1/4		0.70	0.74	0.78	0.85
05B01-286	1/4 x 3/8		1.26	1.34	1.40	1.53
05B01-278	3/8 x 1/4		0.91	0.97	1.02	1.11
05B01-279	3/8 x 3/8		1.12	1.19	1.25	1.36
05B01-280	3/8 x 1/2		1.50	1.59	1.69	1.77
05B01-340	1/2 x 3/8		1.74	1.85	1.96	2.06
05B01-281	1/2 x 1/2		1.35	1.45	1.55	1.65



Nut

FEMALE COMPRESSION THREAD

Catalog No.	Size	100+	50+	25+	Each
05B01-252	1/4	0.21	0.22	0.23	0.25
05B01-253	3/8	0.24	0.25	0.26	0.29
05B01-254	1/2	0.26	0.28	0.30	0.32



Union

FEMALE COMPRESSION TO FEMALE COMPRESSION

Catalog No.	Size	100+	50+	25+	Each
05B01-259	1/4 x 1/4	0.75	0.80	0.85	0.90
05B01-256	3/8 x 1/4	1.03	1.09	1.15	1.25
05B01-260	3/8 x 3/8	1.10	1.15	1.20	1.30
05B01-257	1/2 x 3/8	1.20	1.30	1.40	1.50
05B01-270	1/2 x 1/2	1.35	1.45	1.55	1.75



Male Elbow

FEMALE COMPRESSION TO MALE PIPE THREAD

Catalog No.	Size		100+	50+	25+	Each
	1	2				
05B01-282	1/4 x 1/4		1.09	1.15	1.21	1.32
05B01-283	3/8 x 3/8		1.10	1.20	1.30	1.50
05B01-284	3/8 x 1/2		1.70	1.90	2.10	2.25



Compression To Sweat Adapter

Catalog No.	Size		100+	50+	25+	Each
	1	2				
05B01-258	3/8 x 5/8		1.27	1.34	1.41	1.54

Additional price breaks available on most items. Login to your website account or contact your sales representative for pricing.

Compression Adapters



ECONOMY

Ref.#	Catalog No.	Description	100+	50+	25+	Ea.
1	05C03-110	1/4 C x 1/4 MFL	0.96	1.05	1.10	1.15
1	05C03-111	1/4 C x 3/8 MFL	1.33	1.41	1.49	1.57
1	05C03-112	3/8 C x 1/4 MFL	1.25	1.30	1.40	1.50
1	05C03-113	3/8 C x 3/8 MFL	1.41	1.49	1.57	1.71
2	05B01-331	1/4 C x 1/4 B	0.81	0.86	0.90	0.99
2	05B01-330	3/8 C x 3/8 B	1.25	1.30	1.40	1.50
3	04C03-380	1/4 C x 1/4 B	1.20	1.28	1.34	1.46
3	04C03-381	3/8 C x 1/4 B	0.95	1.05	1.15	1.25
3	04C03-382	3/8 C x 3/8 B	1.20	1.30	1.40	1.50



Saddle Valve

Fits 3/8" to 1 3/8" O.D. Copper Tubing
1/4" Compression outlet

Catalog No.	10+	5+	Ea.
05B01-130	3.50	3.75	3.95



Adapt-A-Valve

THREE-WAY COMPRESSION

Perfect for adding an additional water supply line for ice makers, coffee makers, etc.

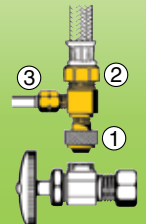

Needle Valve

Compression to Compression

Catalog No.	Size	25+	10+	Each
05B01-132	1/4" x 1/4"	3.05	3.25	3.40
05B01-147	3/8" x 3/8"	2.05	2.25	2.50

Catalog No.	O.D. Tube Inches			100+	25+	10+	Each
	Inlet (1)	Outlet (2)	Outlet (3)				
05K06-102	3/8C	x 3/8C	x 3/8C	5.50	5.95	6.50	6.95

Lead-Free Compliant Brass Fittings

Lead-free as defined by CA Health & Safety Code 116875 (AB1953) is a maximum of 0.25% weighted average lead content of the wetted surface area of parts in contact with drinking water.

Pipe to Pipe Hex Nipple



Catalog No.	Size	100+	50+	25+	Each
05B02-156	1/4 x 1/4	0.97	1.03	1.08	1.17
05B02-157	3/8 x 3/8	1.37	1.45	1.53	1.66
05B02-161	1/2 x 3/8	2.45	2.60	2.75	2.90
05B02-290	1/2 x 1/2	2.17	2.30	2.41	2.63

Pipe to Pipe Bushing



Catalog No.	Size	100+	50+	25+	Each
05B02-139	1/4 x 3/8	0.87	0.92	0.97	1.05
05B02-141	3/8 x 1/2	1.45	1.54	1.64	1.71
05B02-308	3/8 x 3/4	2.63	2.76	2.34	3.00
05B02-318	1/2 x 3/4	7.07	7.48	7.95	8.34

All Female Pipe Tee



Catalog No.	Size	100+	50+	25+	Each
05B02-105	1/4 ALL	2.20	2.40	2.50	2.60

Flare to Pipe Adapter



Catalog No.	Size	100+	50+	25+	Each
05B02-240	1/4 x 1/4	0.59	0.63	0.66	0.72
05B02-226	1/4 x 3/8	1.15	1.22	1.28	1.39
05B02-312	1/4 x 1/2	1.47	1.56	1.64	1.78
05B02-164	3/8 x 1/4	1.43	1.51	1.59	1.73
05B02-289	3/8 x 3/8	1.34	1.43	1.50	1.63
05B02-130	3/8 x 1/2	1.65	1.75	1.86	1.95

Flare to Flare Hex Nipple



Catalog No.	Size	100+	50+	25+	Each
05B02-169	1/4 x 1/4	0.60	0.64	0.67	0.73
05B02-170	3/8 x 3/8	1.48	1.57	1.65	1.80

All Male Flare Tee



Catalog No.	Size	100+	50+	25+	Each
05B02-178	1/4 ALL	1.20	1.28	1.34	1.46
05B02-177	3/8 ALL	2.89	3.06	3.25	3.41

Compression to Pipe Adapter



Catalog No.	Size	100+	50+	25+	Each
05B02-277	1/4 x 1/4	0.77	0.82	0.86	0.93
05B02-286	1/4 x 3/8	1.20	1.28	1.34	1.46
05B02-278	3/8 x 1/4	1.09	1.16	1.21	1.32
05B02-279	3/8 x 3/8	1.09	1.16	1.21	1.32

Compression Union



Catalog No.	Size	100+	50+	25+	Each
05B02-259	1/4 x 1/4	1.26	1.34	1.40	1.53
05B02-256	1/4 x 3/8	1.51	1.60	1.68	1.83
05B02-260	3/8 x 3/8	1.53	1.62	1.72	1.81

Compression Tee



Catalog No.	Size	100+	50+	25+	Each
05B02-124	1/4 ALL	1.75	1.85	1.96	2.06
05B02-220	3/8 ALL	2.50	2.64	2.81	2.95

Barb to Pipe Adapter



Catalog No.	Size	100+	50+	25+	Each
05B02-103	1/4 x 1/4	0.75	0.80	0.84	0.92
05B02-104	1/4 x 3/8	0.83	0.88	0.92	1.00
05B02-334	1/4 x 1/2	1.34	1.41	1.48	1.62
05B02-227	3/8 x 1/4	0.77	0.82	0.86	0.93
05B02-107	3/8 x 3/8	1.01	1.07	1.12	1.22
05B02-261	3/8 x 1/2	1.38	1.47	1.54	1.68
05B02-131	1/2 x 3/8	1.23	1.31	1.37	1.49
05B02-262	1/2 x 1/2	1.53	1.62	1.72	1.81

Compression Needle Valve



Catalog No.	Size	100+	50+	25+	Each
05B02-132	1/4 x 1/4	3.02	3.20	3.40	3.57
05B02-147	3/8 x 3/8	4.33	4.59	4.88	4.86

Barb to Barb Ball Valve



Catalog No.	Size	100+	50+	25+	Each
05B01-346	1/4 x 1/4	4.25	4.50	4.95	5.50
05B01-347	3/8 x 3/8	4.60	4.85	5.15	5.50

Lead-Free Compliant Brass Fittings



Flare Swivel Sets

STAINLESS STEEL STEM AND CHROME PLATED BRASS NUT

1/8" Barb Stem
1/4" FFL Nut



Catalog No.	Size	300+	100+	25+	Each
04C03-264	Swivel Set	1.00	1.07	1.12	1.22
04C03-227	1/8" Stem	0.65	0.69	0.72	0.79
04C03-116	1/4" FFL Nut	0.36	0.38	0.40	0.43

5/32" Barb Stem
1/4" FFL Nut



Catalog No.	Size	300+	100+	25+	Each
04C01-115	Swivel Set	1.08	1.15	1.20	1.31
04C01-114	5/32" Stem	0.76	0.80	0.84	0.92
04C03-116	1/4" FFL Nut	0.36	0.38	0.40	0.43

1/4" Barb Stem
1/4" FFL Nut



Catalog No.	Size	300+	100+	25+	Each
*04C03-265	Swivel Set	0.70	0.75	0.80	0.85
04C03-120	1/4" Stem	0.43	0.46	0.48	0.53
04C03-116	1/4" FFL Nut	0.36	0.38	0.40	0.43

1/4" Barb Stem
5/16" FFL Nut
(1/2-16FFL)



Catalog No.	Size	300+	100+	25+	Each
04C03-266	Swivel Set	1.25	1.33	1.39	1.52
04C03-119	1/4" Stem	0.73	0.77	0.81	0.88
04C03-117	5/16" FFL Nut	0.55	0.59	0.65	0.70

1/4" Barb Stem
3/8" FFL Nut



Catalog No.	Size	300+	100+	25+	Each
04C03-267	Swivel Set	1.37	1.46	1.53	1.67
04C03-121	1/4" Stem	0.80	0.85	0.90	0.98
04C03-118	3/8" FFL Nut	0.57	0.61	0.64	0.70

5/16" Barb Stem
1/4" FFL Nut



Catalog No.	Size	300+	100+	25+	Each
*04C03-293	Swivel Set	0.80	0.85	0.95	1.05
04C03-294	5/16" Stem	0.53	0.56	0.59	0.64
04C03-295	1/4" FFL Nut	0.39	0.41	0.43	0.47

Additional price breaks available on most items. Login to your website account or contact your sales representative for pricing.

3/8" Barb Stem
3/8" FFL Nut



Catalog No.	Size	300+	100+	25+	Each
*04C03-268	Swivel Set	1.25	1.35	1.45	1.55
04C03-124	3/8" Stem	0.80	0.85	0.90	0.98
04C03-118	3/8" FFL Nut	0.57	0.61	0.64	0.70

3/8" Barb Stem
1/2" FFL Nut



Catalog No.	Size	300+	100+	25+	Each
04C03-108	Swivel Set	2.23	2.36	2.51	2.63
04C03-106	3/8" Stem	1.30	1.38	1.45	1.58
04C03-105	1/2" FFL Nut	1.07	1.13	1.19	1.30

1/2" Barb Stem
1/2" FFL Nut



Catalog No.	Size	300+	100+	25+	Each
04C03-109	Swivel Set	2.23	2.36	2.51	2.63
04C03-107	1/2" Stem	1.30	1.38	1.45	1.58
04C03-105	1/2" FFL Nut	1.07	1.13	1.19	1.30



One Piece Swivel Set

Catalog No.	Description	300+	100+	25+	Each
*04C03-123	1/4" FFL x 3/8" Barb	1.25	1.50	1.75	2.25
04C03-151	1/4" FFL x 1/2" Barb	2.81	2.99	3.13	3.41
04C03-129	3/8" FFL x 1/2" Barb	2.57	2.72	2.89	3.11

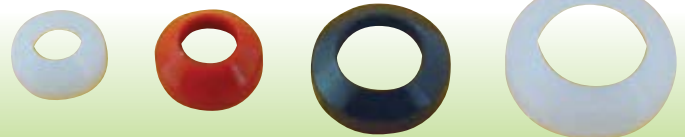

Nylon Flare Washers

Priced per 100

Catalog No.	Color	Size	300+	100+	Each
04E04-291	Clear	1/4"	3.99	4.25	8.00
04E04-290	Red	1/2"-16	3.99	4.25	8.00
04C03-185	Black	3/8"	5.60	5.95	10.00
04C03-190	White	1/2"	27.95	29.95	38.00

Stainless Steel Nut and Stem Fittings

Stainless Steel Flare Fittings

Flare Hose Stem



Catalog No.	Tubing I.D. Size	100+	50+	25+	Each
*04C03-125	1/4" MFL x 1/4" Barb	1.30	1.40	1.50	1.75
*04C03-232	1/4" MFL x 3/8" Barb	1.00	1.10	1.20	1.30
*04C03-230	1/2"-16" MFL x 1/4" Barb	1.30	1.40	1.50	1.75
*04C03-126	1/2"-16" MFL x 3/8" Barb	1.50	1.60	1.70	1.80
*04C03-231	3/8" MFL x 1/4" Barb	1.70	1.80	1.95	2.25
*04C03-127	3/8" MFL x 3/8" Barb	1.75	1.85	1.95	2.25



Flare Adapter



Catalog No.	Size	100+	50+	25+	Each
*04C03-281	1/4 x 1/4	0.95	1.05	1.15	1.25
*04C03-233	1/4 x 1/2-16	1.10	1.20	1.30	1.40
04C03-146	1/4 x 3/8	1.88	2.00	2.10	2.29
04C03-234	1/2-16 x 1/2-16	1.39	1.48	1.55	1.69
04C03-236	3/8 x 3/8	1.91	2.03	2.13	2.33



Flare to Pipe Adapter



Catalog No.	Size	100+	50+	25+	Each
04C03-163	1/4 MFL x 1/8 MPT	1.95	2.05	2.20	2.30
*04C03-240	1/4 MFL x 1/4 MPT	1.34	1.42	1.49	1.65
04C03-226	1/4 MFL x 3/8 MPT	2.86	3.03	3.22	3.38
*04C03-312	1/4 MFL x 1/2 MPT	5.95	6.25	6.50	6.95
04C03-164	3/8 MFL x 1/4 MPT	2.57	2.72	2.89	3.03
04C03-289	3/8 MFL x 3/8 MPT	1.75	1.85	1.95	2.10
04C03-130	3/8 MFL x 1/2 MPT	4.50	4.75	5.00	5.50
04C03-165	1/2 MFL x 1/2 MPT	5.95	6.30	6.59	6.97



Flare to Flare Union

Catalog No.	Size	100+	50+	25+	Each
04C03-150	1/4 FFL to 3/8 MFL	2.20	2.35	2.45	2.65
04C03-198	3/8 FFL to 1/4 MFL	CLOSEOUT 3.95			

Flare Cap Nut



Catalog No.	Size	300+	100+	25+	Each
04C03-145	1/4" MFL	0.79	0.84	0.88	0.96
04C03-248	1/2-16" FFL	-	-	-	1.95
04C03-249	3/8" MFL	1.85	1.96	2.08	2.19

Flare Plug



Catalog No.	Size	300+	100+	25+	Each
04C03-147	1/4" MFL	0.86	0.92	0.96	1.05
04C03-292	3/8" MFL	1.14	1.21	1.27	1.39

Branch Tee W/FFL SWIVEL NUT



Flare Tee ALL MALE FLARE



Swivel Tee BARB TO FLARE

Catalog No.	Size	100+	50+	25+	Each
04C03-261	1/4	4.85	5.15	5.45	5.75
04C03-262	3/8	CLOSEOUT 8.95			

Catalog No.	Size	100+	50+	25+	Each
04C03-228	1/4	2.77	2.94	3.12	3.27
04C03-239	3/8	4.41	4.67	4.96	5.20

Catalog No.	Size	100+	50+	25+	Each
04C01-134	1/4	3.65	3.85	4.07	4.35

Swivel Elbows



Ref. #	Catalog No.	Size	100+	50+	25+	Each
1	04C03-174	45° Swivel Elbow, 1/4FFL x 1/4 barb	1.85	1.97	2.07	2.25
*2	04C03-133	90° Swivel Elbow, 1/4FFL x 1/4 barb	1.35	1.45	1.55	1.75
*2	04C03-253	90° Swivel Elbow, 1/4FFL x 3/8 barb	2.25	2.50	2.75	2.95
2	04C03-250	90° Swivel Elbow, 1/2-16FFL x 1/4 barb	-	-	-	2.95
2	04C03-296	90° Swivel Elbow, 3/8FFL x 1/4 barb	1.79	1.90	1.99	2.17
*2	04C03-251	90° Swivel Elbow, 3/8FFL x 3/8 barb	1.50	1.75	1.95	2.25
2	04C03-252	90° Swivel Elbow, 3/8FFL x 1/2 barb	4.97	5.24	5.81	6.22
2	04C03-311	90° Swivel Elbow, 1/2FFL x 3/8 barb	5.25	5.50	5.75	6.25
*2	04C03-162	90° Swivel Elbow, 1/2FFL x 1/2 barb	3.41	3.62	3.80	4.14
3	04C03-173	180° Swivel Elbow, 1/4FFL x 1/4 barb	2.56	2.72	2.86	3.11

Bulkhead Adapters



Ref.#	Catalog No.	Size	25+	10+	Each
1	04K03-286	3" Length x 1/4" MFL	1.55	1.65	1.75
2	04K03-287	4" Length x 1/4" MFL	2.65	2.80	2.95

Panel Mount Adapters



Ref.#	Catalog No.	Size	25+	10+	Each
1	04C03-171	1/4" MFL x 1/4" MFL	2.35	2.49	2.62
2	04C03-194	1/4" MFL x 1/4" Barb	4.49	4.77	5.01
3	04C03-195	1/4" MFL x 3/8" Barb	4.13	4.49	4.77

Stainless Steel Flare Fittings

Stainless Steel Pipe Fittings

Hex Head Plug

Male Pipe



Catalog No.	Description	100+	50+	25+	Each
*04C03-333	1/8" MPT	0.95	1.01	1.06	1.16
*04C03-153	1/4" MPT	1.41	1.50	1.58	1.72
*04C03-334	3/8" MPT	1.53	1.63	1.71	1.86
*04C03-335	1/2" MPT	1.85	1.99	2.10	2.25
*04C03-391	3/4" MPT	2.50	2.75	2.95	3.25

Hex Nipple

Male Pipe to Male Pipe



Catalog No.	Description	100+	50+	25+	Each
04C03-330	1/4" MPT x 1/8" MPT	2.12	2.25	2.36	2.57
*04C03-331	1/4" MPT x 1/4" MPT	1.92	2.03	2.16	2.26
04C03-222	3/8" MPT x 1/4" MPT	2.89	3.06	3.25	3.41
*04C03-144	3/8" MPT x 3/8" MPT	2.54	2.69	2.83	3.08
*04C03-389	1/2" MPT x 1/2" MPT	2.75	2.95	3.25	3.50
*04C03-390	3/4" MPT x 3/4" MPT	3.25	3.50	3.75	3.95

Hex Bushing

Female Pipe to Male Pipe



Catalog No.	Description	100+	50+	25+	Each
*04C03-336	1/8" FPT x 1/4" MPT	1.69	1.80	1.89	2.05
*04C03-338	1/4" FPT x 3/8" MPT	1.45	1.55	1.75	2.25
*04C03-339	1/4" FPT x 1/2" MPT	2.75	3.00	3.25	3.50
*04C03-340	3/8" FPT x 1/2" MPT	3.00	3.25	3.40	3.75
*04C03-379	1/2" FPT x 3/4" MPT	2.75	2.95	3.25	3.55

Round Coupler

Female Pipe to Female Pipe



Catalog No.	Description	100+	50+	25+	Each
*04C03-310	1/4" FPT x 1/4" FPT	1.95	2.50	2.95	3.50
*04C03-354	3/8" FPT x 3/8" FPT	2.95	3.25	3.50	3.95
*04C03-355	1/2" FPT x 1/2" FPT	2.95	3.25	3.50	3.95
*04C03-392	3/4" FPT x 3/4" FPT	3.25	3.50	3.95	4.25

Additional price breaks available on most items. Login to your website account or contact your sales representative for pricing.

PTFE Thread Seal Tape

For sealing NPT threads

- Provides a leak-free, air-tight seal
- Prevents seizing or cross-threading
- For use on air, water and other fittings
- Can be used on brass, copper, stainless



Catalog No.	Description	Each
20D01-200	PTFE Tape	3.72
20D01-201	Liquid Thread Sealant (4 oz.)	6.78
20D01-202	Application Brush	0.15

1/2"W x 1429"L



Hex Adapter

Female Pipe to Male Flare



Catalog No.	Description	100+	50+	25+	Each
*04C03-313	3/8" FPT x 1/4" MFL	3.18	3.38	3.55	3.86
04C03-199	3/8" FPT x 3/8" MFL	CLOSEOUT		4.95	
*04C03-314	1/2" FPT x 1/4" MFL	5.10	5.41	5.68	6.19

Hex Adapter

Male Flare to Male Pipe



Catalog No.	Description	100+	50+	25+	Each
04C03-163	1/4" MFL x 1/8" MPT	1.95	2.05	2.20	2.30
*04C03-240	1/4" MFL x 1/4" MPT	1.34	1.42	1.49	1.65
04C03-226	1/4" MFL x 3/8" MPT	2.86	3.03	3.22	3.38
*04C03-312	1/4" MFL x 1/2" MPT	5.95	6.25	6.50	6.95
04C03-164	3/8" MFL x 1/4" MPT	2.57	2.72	2.89	3.03
04C03-289	3/8" MFL x 3/8" MPT	1.75	1.85	1.95	2.10
04C03-130	3/8" MFL x 1/2" MPT	4.50	4.75	5.00	5.50
04C03-165	1/2" MFL x 1/2" MPT	5.95	6.30	6.59	6.97

Hex Adapter

Female Flare to Male Pipe



Catalog No.	Description	100+	50+	25+	Each
04C03-323	1/4" FFL x 1/8" MPT	CLOSEOUT		4.95	
*04C03-324	1/4" FFL x 1/4" MPT	3.31	3.51	3.72	3.91
04C03-325	1/4" FFL x 3/8" MPT	CLOSEOUT		4.95	
04C03-327	3/8" FFL x 1/4" MPT	CLOSEOUT		4.95	
04C03-328	3/8" FFL x 3/8" MPT	CLOSEOUT		4.95	

Stainless Steel Pipe Fittings

Stainless Steel Pipe Fittings



90° Elbow

Female Pipe to Female Pipe



Catalog No.	Description	100+	50+	25+	Each
*04C03-343	1/4" FPT x 1/4" FPT	1.99	2.25	2.50	2.75
*04C03-344	3/8" FPT x 3/8" FPT	2.50	2.65	2.75	3.25
*04C03-345	1/2" FPT x 1/2" FPT	2.65	2.80	2.95	3.50
*04C03-377	3/4" FPT x 3/4" FPT	3.75	4.00	4.25	4.55



90° Elbow

Male Pipe to Female Pipe



Catalog No.	Description	100+	50+	25+	Each
*04C03-346	1/8" MPT x 1/8" FPT	3.44	3.65	3.83	4.17
*04C03-347	1/4" MPT x 1/8" FPT	CLOSEOUT		3.95	
*04C03-348	1/4" MPT x 1/4" FPT	2.85	2.99	3.50	3.95
*04C03-349	3/8" MPT x 3/8" FPT	3.50	3.75	3.95	4.50
*04C03-350	1/2" MPT x 1/2" FPT	4.25	4.50	4.95	5.50
*04C03-378	3/4" MPT x 3/4" FPT	5.55	5.95	6.25	6.75



Tee

Female Pipe on All



Catalog No.	Description	100+	50+	25+	Each
*04C03-221	1/4" FPT on All	3.25	3.50	3.75	4.00
*04C03-356	3/8" FPT on All	3.50	3.75	3.95	4.50
*04C03-357	1/2" FPT on All	3.95	4.25	4.50	4.95
*04C03-376	3/4" FPT on All	5.50	5.95	6.50	6.95



Cross

Female Pipe on All



Catalog No.	Description	100+	50+	25+	Each
*04C03-359	1/4" FPT on All	4.95	5.50	5.95	6.50
*04C03-360	3/8" FPT on All	5.95	6.50	6.95	7.50
*04C03-361	1/2" FPT on All	6.95	7.50	7.95	8.50
*04C03-374	3/4" FPT on All	12.50	12.95	13.95	14.95



Hex Adapter

Barb to Male Pipe



Catalog No.	Description	100+	50+	25+	Each
04C03-225	1/4" Barb x 1/8" MPT	1.76	1.87	1.99	2.08
*04C03-128	1/4" Barb x 1/4" MPT	1.55	1.65	1.75	1.95
04C03-166	1/4" Barb x 3/8" MPT	2.39	2.54	2.67	2.91
04C03-167	3/8" Barb x 1/8" MPT	2.28	2.41	2.56	2.69
*04C03-168	3/8" Barb x 1/4" MPT	1.60	1.70	1.80	1.95
*04C03-131	3/8" Barb x 3/8" MPT	2.05	2.15	2.25	2.50
*04C03-205	3/8" Barb x 1/2" MPT	2.95	3.25	3.50	3.75
04C03-169	1/2" Barb x 1/4" MPT	2.45	2.60	2.75	2.95
04C03-170	1/2" Barb x 3/8" MPT	2.47	2.63	2.75	3.00
04C03-140	1/2" Barb x 1/2" MPT	3.40	3.60	3.83	4.02
*04C03-375	3/4" Barb x 3/4" MPT	4.55	4.85	5.15	5.40



Hex Adapter

Female Pipe to Barb



Catalog No.	Description	100+	50+	25+	Each
04C03-223	1/8" FPT x 1/4" Barb	CLOSEOUT		2.95	
*04C03-224	1/4" FPT x 1/4" Barb	1.65	1.75	1.85	1.95
*04C03-218	1/4" FPT x 3/8" Barb	3.80	4.03	4.23	4.61
*04C03-216	3/8" FPT x 1/4" Barb	3.81	4.05	4.25	4.63
*04C03-215	1/2" FPT x 1/2" Barb	3.35	3.55	3.75	4.05



90° Adapter

Barb to Male Pipe

Catalog No.	Description	100+	50+	25+	Each
04C03-273	1/4" Barb x 1/8" MPT	3.55	3.75	3.96	4.25
04C03-274	1/4" Barb x 1/4" MPT	3.40	3.60	3.82	4.01
04C03-275	1/4" Barb x 3/8" MPT	3.72	3.94	4.18	4.39
04C03-279	3/8" Barb x 1/4" MPT	3.54	3.75	3.99	4.18
04C03-280	3/8" Barb x 3/8" MPT	4.25	4.50	4.75	4.95
04C03-283	3/8" Barb x 1/2" MPT	2.94	3.13	3.13	3.58
04C03-284	1/2" Barb x 1/2" MPT	5.50	5.95	6.50	6.95



90° Adapter

Barb to Female Pipe

Catalog No.	Description	100+	50+	25+	Each
04C03-175	3/8" Barb x 1/4" FPT	CLOSEOUT		4.95	
04C03-176	3/8" Barb x 3/8" FPT	CLOSEOUT		5.95	

Stainless Steel Pipe Fittings

Stainless Steel Hose Barb Fittings

Straight



Catalog No.	Tubing I.D. Size	100+	50+	25+	Each
04C03-299	1/8"	1.62	1.72	1.81	1.97
04C03-291	1/8" x 1/4"	1.75	1.85	1.95	2.15
*04C03-142	3/16" x 3/16"	1.25	1.35	1.45	1.75
*04C03-351	3/16" x 1/4"	1.35	1.45	1.55	1.75
*04C03-352	3/16" x 3/8"	2.00	2.25	2.50	2.95
*04C03-139	1/4"	0.80	0.85	0.90	1.00
*04C11-139	1/4" Thinwall	0.55	0.60	0.65	0.70
*04C03-366	1/4" x 5/16"	0.70	0.80	0.85	0.95
*04C03-254	1/4" x 3/8"	1.05	1.15	1.35	1.50
*04C11-254	1/4" x 3/8" Thinwall	0.65	0.75	0.80	0.85
04C03-141	1/4" x 1/2"	1.30	1.40	1.50	1.55
*04C11-141	1/4" x 1/2" Thinwall	1.04	1.11	1.16	1.26
*04C03-367	5/16"	0.75	0.80	0.85	0.90
*04C03-370	5/16" x 3/8"	0.75	0.80	0.85	0.95
*04C03-282	3/8"	1.15	1.25	1.35	1.50
*04C11-282	3/8" Thinwall	0.80	0.90	0.95	1.05
*04C03-255	3/8" x 1/2"	1.35	1.45	1.55	1.65
*04C11-255	3/8" x 1/2" Thinwall	1.20	1.30	1.40	1.50
04C03-143	1/2"	1.34	1.43	1.50	1.63
*04C11-143	1/2" Thinwall	0.85	0.95	1.05	1.15
04C03-148	3/4"	2.53	2.69	2.82	3.08

Tee



Catalog No.	Tubing I.D. Size	100+	50+	25+	Each
*04C03-134	1/4" (ALL)	2.05	2.15	2.25	2.50
*04C11-134	1/4" (ALL) Thinwall	0.75	0.80	0.85	0.90
*04C03-135	1/4" (1&2) x 3/8" (3)	1.95	2.05	2.25	2.50
*04C11-135	1/4" (1&2) x 3/8" Thinwall	0.90	0.95	1.05	1.15
*04C03-290	5/16" (ALL)	2.80	3.00	3.25	3.50
*04C11-290	5/16" (ALL) Thinwall	1.65	1.75	1.85	1.95
*04C03-136	3/8" (1&2) x 1/4" (3)	1.95	2.25	2.50	2.95
*04C11-136	3/8" (1&2) x 1/4" Thinwall	1.00	1.05	1.10	1.25
*04C03-213	3/8" (ALL)	2.35	2.55	2.75	2.95
*04C11-213	3/8" (ALL) Thinwall	1.10	1.20	1.30	1.40
04C03-308	3/8" (1&2) x 1/2" (3)	6.65	6.95	7.45	7.95
*04C11-308	3/8" (1&2) x 1/2" (3) Thinwall	2.29	2.45	2.57	2.80
04C03-137	1/2" (1&2) x 1/4" (3)	5.75	6.10	6.45	7.05
04C03-259	1/2" (1&2) x 3/8" (3)	6.61	6.97	7.38	7.84
*04C11-259	1/2" (1&2) x 3/8" Thinwall	1.68	1.79	1.88	2.04
04C03-258	1/2" (ALL)	6.05	6.40	6.75	7.25
*04C11-258	1/2" (ALL) Thinwall	1.75	1.85	1.95	2.25
04C03-278	3/4" (ALL)	4.59	4.97	5.33	5.74

Additional price breaks available on most items. Login to your website account or contact your sales representative for pricing.

Plug



Catalog No.	Tubing I.D. Size	100+	50+	25+	Each
*04C03-103	1/4"	0.42	0.44	0.47	0.51
*04C11-103	1/4" Thinwall	0.27	0.29	0.33	0.35
04C03-487	5/16"	0.68	0.72	0.76	0.83
*04C03-104	3/8"	0.74	0.78	0.82	0.90
*04C11-104	3/8" Thinwall	0.45	0.50	0.55	0.60
04C03-111	1/2"	1.30	1.38	1.45	1.58

"Y" Tee

90° Leg Angle

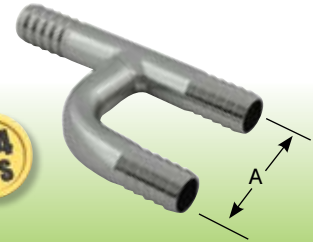

Catalog No.	Tubing I.D. Size	100+	50+	25+	Each
04E04-190	1/4" A = 1 1/8"	5.00	5.30	5.65	5.95
*04C11-190	1/4" Thinwall A = 1 1/8"	1.15	1.25	1.35	1.55
04E04-191	3/8" A = 1 1/4"	4.59	4.86	5.17	5.50
*04C11-191	3/8" Thinwall A = 1 1/4"	1.55	1.65	1.75	1.95

Elbow



Catalog No.	Tubing I.D.	100+	50+	25+	Each
*04C03-256	1/4"	0.75	0.85	0.95	1.10
*04C11-256	1/4" Thinwall	0.40	0.45	0.50	0.60
04C03-110	1/4" x 3/8"	3.08	3.38	3.58	3.81
*04C11-110	1/4" x 3/8" Thinwall	1.24	1.32	1.38	1.50
*04C03-269	5/16"	1.00	1.10	1.20	1.35
*04C03-257	3/8"	1.25	1.35	1.45	1.55
*04C11-257	3/8" Thinwall	0.75	0.80	0.85	0.95
04C03-309	1/2" x 3/8"	4.06	4.31	4.52	4.93
04C03-132	1/2"	3.15	3.40	3.60	3.85
*04C11-132	1/2" Thinwall	1.85	1.95	2.05	2.25

Cross



Catalog No.	Tubing I.D. Size	100+	50+	25+	Each
04C03-138	1/4"	3.66	3.86	4.20	4.46
*04C11-138	1/4" Thinwall	1.40	1.50	1.60	1.75
04C03-263	3/8" x 1/4" x 3/8" x 1/4"	4.70	4.97	5.28	5.54
04C03-260	3/8"	4.58	4.82	5.25	5.58
*04C11-260	3/8" Thinwall	1.95	2.15	2.25	2.45
04C03-270	1/2"	8.30	8.76	9.30	9.86

Stainless Steel Barbed Fittings

Stainless Steel Hose Barb Fittings



Adapter

Barb to Female Flare



Catalog No.	Tubing I.D. Size	100+	50+	25+	Each
*04C03-125	1/4" B x 1/4" MFL	1.30	1.40	1.50	1.75
*04C03-230	1/4" B x 1/2-16 MFL	1.30	1.40	1.50	1.75
*04C03-231	1/4" B x 3/8" MFL	1.70	1.80	1.95	2.25
*04C03-232	3/8" B x 1/4" MFL	1.00	1.10	1.20	1.30
*04C03-126	3/8" B x 1/2-16 MFL	1.50	1.60	1.70	1.80
*04C03-127	3/8" B x 3/8" MFL	1.75	1.85	1.95	2.25



90° Adapter

Barb to Male Flare

Catalog No.	Tubing I.D. Size	100+	50+	25+	Each
04C03-277	3/8" B x 3/8" MFL	3.98	4.22	4.48	4.70



45° Swivel Adapter

Barb to Female Flare

Catalog No.	Tubing I.D. Size	100+	50+	25+	Each
04C03-174	1/4" B x 1/4" FFL	1.85	1.97	2.07	2.25



U-Bend

Barb to Barb



Catalog No.	Tubing I.D. Size	100+	50+	25+	Each
04C03-112	1/4" Barb A = 1-1/4"	1.88	1.99	2.12	2.22
*04C11-112	1/4" Barb Thinwall A = 1"	1.05	1.15	1.25	1.50
04C03-483	5/16" Barbs A = 2"	3.00	3.25	3.50	3.75
*04C03-114	3/8" Barbs A = 2"	1.75	1.95	2.25	2.50
*04C11-114	3/8" Barbs Thinwall A = 1-1/4"	1.15	1.20	1.25	1.35
04C03-186	1/2" Barbs A = 3"	4.00	4.24	4.50	4.72
*04C11-186	1/2" Barbs Thinwall A = 2-1/8"	2.22	2.36	2.48	2.70

Additional price breaks available on most items. Login to your website account or contact your sales representative for pricing.



90° Swivel Adapter

Barb to Female Flare



Catalog No.	Tubing I.D. Size	100+	50+	25+	Each
*04C03-133	1/4" B x 1/4" FFL	1.35	1.45	1.55	1.75
04C03-250	1/4" B x 1/2-16" FFL	CLOSEOUT		2.95	
04C03-296	1/4" B x 3/8" FFL	1.79	1.90	1.99	2.17
*04C03-253	3/8" B x 1/4" FFL	2.25	2.50	2.75	2.95
*04C03-251	3/8" B x 3/8" FFL	1.50	1.75	1.95	2.25
04C03-311	3/8" B x 1/2" FFL	5.25	5.50	5.75	6.25
04C03-252	1/2" B x 3/8" FFL	4.97	5.24	5.81	6.22
*04C03-162	1/2" B x 1/2" FFL	3.41	3.62	3.80	4.14



U-Bend with Manifold

Two Barbs to Barb



Catalog No.	Tubing I.D. Size	100+	50+	25+	Each
04C03-113	1/4" Barbs x 1/4" Barb Man. A = 1-3/8"	4.40	4.70	4.95	5.25
*04C11-113	1/4" Barbs x 1/4" B Thinwall A = 1"	1.05	1.15	1.25	1.50
04C03-122	1/4" Barbs x 3/8" Barb Man. A = 1-1/2"	4.80	5.10	5.36	5.75
04C03-484	5/16" Barbs x 5/16" Barb Man. A = 21/4"	9.50	9.95	10.95	11.50
*04C11-484	5/16" B x 5/16" B Thinwall A = 1-1/4"	2.32	2.50	2.95	2.32
04C03-188	3/8" Barbs x 1/4" Barb Man. A = 2-1/2"	4.68	5.10	5.41	5.68
04C03-189	3/8" Barbs x 3/8" Barb Man. A = 1-5/8"	4.46	4.76	5.25	5.58
*04C11-189	3/8" B x 3/8" B Thinwall A = 1-5/8"	1.70	1.80	1.90	2.10
04C03-368	3/8" Barbs x 1/2" Barb Man. A = 2"	5.64	5.95	6.47	6.87
04C03-192	1/2" Barbs x 3/8" Barb Man. A = 2-1/4"	4.49	4.76	5.20	5.61
04C03-191	1/2" Barbs x 1/2" Barb Man. A = 2-1/4"	4.49	4.76	5.20	5.61



180° Swivel Adapter

Barb to Female Flare

Catalog No.	Tubing I.D. Size	100+	50+	25+	Each
04C03-173	1/4" B x 1/4" FFL	2.56	2.72	2.86	3.11

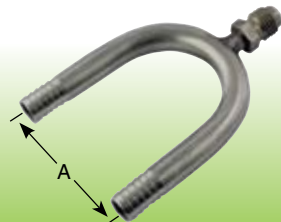

U-Bend with Manifold

Two Barbs to Male Flare

Catalog No.	Tubing I.D. Size	100+	50+	25+	Each
04C03-115	3/8" Barbs x 1/4 MFL Man. A = 2"	5.05	5.35	5.75	6.25
04C03-187	1/2" Barbs x 1/4 MFL Man. A = 3-1/2"	4.44	4.76	5.22	5.55

Stainless Steel Barbed Fittings

Stainless Steel CO₂ / Soda Fountain Fittings

CO₂ Valve Fitting



CO₂ Valve Fitting



CO₂ Regulator Fitting



CO₂ Washer
02H06-294 **10¢**

Ref.#	Catalog No.	Description	100+	50+	25+	Each
1	04E04-391	Swivel Set, CO2 x 1/4" Barb	3.25	3.50	3.75	3.95
1	04C03-101	Stem Only, 1/4" Barb	1.80	1.90	2.00	2.10
1	04E04-458	Swivel Nut Only, CO2	2.25	2.40	2.55	2.70

Ref.#	Catalog No.	Description	100+	50+	25+	Each
2	04E04-120	CO2 x 1/4" MFL	3.50	3.85	4.05	4.25
3	04E04-392	Male 1/2" CO2 x 1/4" Barb	3.97	4.35	4.65	4.95
3	04C03-177	Male 1/2" CO2 x 3/8" Barb	3.97	4.35	4.65	4.95

Stainless Steel Compression Fittings



WARNING: It is recommended to flare all stainless steel tubes instead of using compression fittings. Manufacturer will not be held liable for any damages incurred from using compressions fittings

Ref.#	Catalog No.	Description	Each
1	04C03-373	3/8" MFL x 3/8" O.D. Tube	4.95
2	04C03-220	1/4" MPT x 3/8" O.D. Tube	5.27
3	04C03-383	1/4" Barb x 1/4" O.D. Tube	3.22
3	04C03-384	1/4" Barb x 5/16" O.D. Tube	4.87
3	04C03-385	1/4" Barb x 3/8" O.D. Tube	4.95
3	04C03-386	3/8" Barb x 1/4" O.D. Tube	3.12
3	04C03-387	3/8" Barb x 5/16" O.D. Tube	4.07
3	04C03-388	3/8" Barb x 3/8" O.D. Tube	4.07

Stainless Steel Field Kit

- | | | |
|------------------------------|-------------------------------|----------------------------------|
| 2 Adapter 1/4"B x 1/2"-16MFL | 50 Oetiker Clamp 14.5 | 10 Stem 1/4" (for 3/8" Nut) |
| 2 Adapter 1/4"B x 1/4" MFL | 100 Oetiker Clamp 17.0 | 15 Stem 3/8" (for 3/8" Nut) |
| 1 Cap Nut 1/4" | 10 Plug 1/4" Barb | 5 Swivel Elbow 1/4" B x 1/4 FFL |
| 1 Cap Nut 3/8" | 5 Plug 3/8" Barb | 3 Swivel Elbow 3/8" B x 3/8" FFL |
| 5 Cross 1/4" Barbs | 15 Splicer 1/4" B x 3/8" B | 20 Tee 1/4" Barbs |
| 200 Flare Washer 1/4" | 25 Splicer 1/4" Barb | 2 Tee 1/4" Barbs x 3/8" Barb |
| 100 Flare Washer 3/8" | 10 Splicer 3/8" Barb | 10 Tee 3/8" Barbs |
| 50 Nut 1/4" | 1 Splicer Elbow 1/4" Barb | 5 Tee 3/8" Barbs x 1/4" Barb |
| 1 Nut 1/2"-16 | 1 Splicer Elbow 3/8" Barb | 1 U-Bend Manifold 3/8" Barbs |
| 25 Nut 3/8" | 1 Stem 1/4" (for 1/2"-16 Nut) | 1 Side-Jaw Pincers |
| 100 Oetiker Clamp 12.3 | 50 Stem 1/4" (for 1/4" Nut) | 1 Tubing Cutter |

2 SIDED CASE
14F02-101
\$295.95



Additional price breaks available on most items. Login to your website account or contact your sales representative for pricing.

Solid Brass Insert Tool for Flared Fittings

Makes installation easy! Works as a handle and holds fitting in place while inserting into tubing.



20D03-101
\$4.95

Works with 1/4" FFL and 3/8" FFL fittings

DMfit® Spanner Wrench Set for Push-on Fittings



Catalog No.	Description	10+	5+	Each
20P22-105	3/16" Spanner	1.00	1.06	1.12
20P22-106	1/4" Spanner	1.00	1.06	1.12
20P22-107	5/16" Spanner	1.00	1.06	1.12
20P22-108	3/8" Spanner	1.00	1.06	1.12
20P22-109	1/2" Spanner	1.00	1.06	1.12



20D03-105

3/16", 1/4", 5/16", 3/8", 1/2"

10+ **\$4.84**
5+ \$5.05 Ea. \$5.37

Stainless Steel CO₂ and Compression Fittings



DMfit® Push-In Tube Fittings

PROVIDES QUICK & CONVENIENT ASSEMBLY

Products are manufactured from safe, non-toxic materials meeting the requirements of the US FDA, ANSI/NSF-51, 61, and SK Zert. Do not use this product where the ambient temperature or fluid temperature may exceed 180°F. Maximum operating pressure -40°F to 68°F is 230 PSI / 149°F is 150 PSI.



End Stop

Catalog No.	Description	25+	10+	Each
05P22-142	1/4" O.D.	0.68	0.73	0.76
05P22-143	3/8" O.D.	0.87	0.93	0.97
05P22-175	1/2" O.D.	1.08	1.15	1.20



Union

Catalog No.	Description	25+	10+	Each
05P22-112	1/4" O.D. x 1/4" O.D.	0.94	1.00	1.04
05P22-136	1/4" O.D. x 3/8" O.D.	1.29	1.37	1.43
05P22-109	5/16" O.D. x 3/8" O.D.	1.37	1.45	1.52
05P22-113	3/8" O.D. x 3/8" O.D.	1.32	1.40	1.47
05P22-115	3/8" O.D. x 1/2" O.D.	1.56	1.65	1.74
05P22-114	1/2" O.D. x 1/2" O.D.	1.60	1.70	1.79



Elbow

Catalog No.	Description	25+	10+	Each
05P22-120	1/4" O.D. x 1/4" O.D.	1.11	1.18	1.24
05P22-150	1/4" O.D. x 3/8" O.D.	1.43	1.52	1.59
05P22-121	3/8" O.D. x 3/8" O.D.	1.46	1.55	1.63
05P22-149	3/8" O.D. x 1/2" O.D.	1.70	1.81	1.89
05P22-122	1/2" O.D. x 1/2" O.D.	1.81	1.92	2.02



Tee

Catalog No.	Description	25+	10+	Each
05P22-104	1/4" O.D. (ALL)	1.30	1.38	1.45
05P22-160	3/8" x 3/8" x 1/4" O.D.	1.60	1.70	1.79
05P22-105	3/8" O.D. (ALL)	1.62	1.72	1.81
05P22-130	1/2" x 1/2" x 3/8" O.D.	1.83	1.94	2.04
05P22-107	1/2" O.D. (ALL)	1.94	2.06	2.16



Cross

**DISC. ITEM
LIMITED STOCK**

Catalog No.	Description	25+	10+	Each
05P22-176	1/4" O.D. (ALL)	-	-	2.95
05P22-177	1/2" O.D. (ALL)	-	-	2.95



Wye

Catalog No.	Description	25+	10+	Each
05P22-191	1/4" O.D. (ALL)	1.52	1.62	1.70
05P22-192	5/16" O.D. (ALL)	1.57	1.67	1.75
05P22-193	3/8" O.D. (ALL)	1.79	1.91	2.00
05P22-195	1/2" O.D. (ALL)	1.99	2.11	2.21

Additional price breaks available on most items. Login to your website account or contact your sales representative for pricing.



U Bend

Catalog No.	Description	25+	10+	Each
05P22-210	1/4" O.D.	1.35	1.43	1.50
05P22-211	3/8" O.D.	2.05	2.18	2.28
05P22-212	1/2" O.D.	2.18	2.31	2.43



Female Pipe & Female Flare Adapters

Catalog No.	Description	25+	10+	Each
05P22-144	1/4" FPT x 1/4" O.D.	1.14	1.22	1.27
05P22-145	1/4" FPT x 3/8" O.D.	1.43	1.52	1.59
05P22-185	1/4" FFL x 1/4" O.D.	1.25	1.33	1.40
05P22-116	1/4" FFL x 3/8" O.D.	1.43	1.52	1.59
05P22-205	3/8" FFL x 3/8" O.D.	1.46	1.55	1.63



Male Flare Adapter

Catalog No.	Description	25+	10+	Each
05P22-207	1/4" MFL x 3/8" O.D.	1.32	1.40	1.47



Push-In Shutoff

Catalog No.	Description	25+	10+	Each
05P22-131	1/4" O.D.	3.95	4.20	4.41
05P22-132	3/8" O.D.	4.18	4.44	4.66
05P22-178	1/2" O.D.	6.04	6.41	6.73



Male Pipe to Push-In Shutoff

Catalog No.	Description	25+	10+	Each
05P22-133	3/8" MPT x 3/8" O.D.	4.27	4.54	4.76



Bulkhead Adapter

Catalog No.	Description	25+	10+	Each
05P22-135	3/8" O.D.	1.97	2.09	2.20
05P22-127	1/2" O.D.	2.29	2.43	2.55

Fittings listed fit the following tubings:

1/4" O.D. fits 08H05-154 / 5/16" O.D. fits 08H05-247 / 3/8" O.D. fits 08H05-115 / 1/2" O.D. fits 08H05-116



DMfit® Push-In Tube Fittings



PROVIDES QUICK & CONVENIENT ASSEMBLY

Products are manufactured from safe, non-toxic materials meeting the requirements of the US FDA, ANSI/NSF-51, 61, and SK Zert. Do not use this product where the ambient temperature or fluid temperature may exceed 180°F. Maximum operating pressure -40°F to 68°F is 230 PSI / 149°F is 150 PSI.

STEMS FIT INTO OTHER PUSH-IN FITTINGS



Reducer

Catalog No.	Description	25+	10+	Each
05P22-158	3/8" Stem x 5/16" O.D.	1.19	1.27	1.33
05P22-156	1/2" Stem x 3/8" O.D.	1.51	1.60	1.68



Elbow

Catalog No.	Description	25+	10+	Each
05P22-180	1/4" Stem x 1/4" O.D.	0.94	1.00	1.04
05P22-181	3/8" Stem x 1/4" O.D.	1.10	1.16	1.22
05P22-182	3/8" Stem x 3/8" O.D.	1.27	1.35	1.42
05P22-183	1/2" Stem x 1/2" O.D.	1.49	1.59	1.66



Male Pipe Adapter

Catalog No.	Description	25+	10+	Each
05P22-123	1/4" Stem x 1/4" MPT	0.44	0.47	0.50
05P22-124	3/8" Stem x 1/4" MPT	0.54	0.57	0.60
05P22-125	3/8" Stem x 3/8" MPT	0.60	0.64	0.67
05P22-137	1/2" Stem x 3/8" MPT	0.73	0.78	0.82
05P22-138	1/2" Stem x 1/2" MPT	0.92	0.98	1.03



Check Valve

Catalog No.	Description	25+	10+	Each
05P22-200	1/4" O.D. Tube	7.31	7.76	8.14
05P22-201	3/8" O.D. Tube	8.39	8.91	9.35



Plug Stem

Catalog No.	Description	25+	10+	Each
05P22-155	3/8" O.D. Stem	0.44	0.47	0.50
05P22-153	1/2" O.D. Stem	0.48	0.51	0.53



Male Pipe Adapter

Catalog No.	Description	25+	10+	Each
05P22-118	1/4" MPT x 1/4" O.D.	0.83	0.88	0.92
05P22-110	1/4" MPT x 3/8" O.D.	1.25	1.33	1.40
05P22-111	3/8" MPT x 3/8" O.D.	1.35	1.43	1.50
05P22-126	3/8" MPT x 1/2" O.D.	1.54	1.64	1.72
05P22-108	1/2" MPT x 3/8" O.D.	1.43	1.52	1.59
05P22-119	1/2" MPT x 1/2" O.D.	1.70	1.81	1.89



S/S Straight Barb to Stem

Catalog No.	Description	25+	10+	Each
04C03-206	1/4" B x 1/4" Stem	1.49	1.57	1.71
04C03-207	1/4" B x 3/8" Stem	1.49	1.57	1.71
04C03-208	3/8" B x 3/8" Stem	1.49	1.57	1.71
04C03-211	3/8" B x 1/2" Stem	2.36	2.48	2.70
04C03-209	1/2" B x 3/8" Stem	3.00	3.18	3.34
04C03-210	1/2" B x 1/2" Stem	2.87	3.01	3.28



Elbow Barb to Stem

Catalog No.	Description	25+	10+	Each
05P22-196	1/4" B x 1/4" Stem	0.68	0.73	0.76
05P22-199	1/4" B x 5/16" Stem	0.73	0.78	0.81
05P22-197	1/4" B x 3/8" Stem	0.81	0.86	0.90
05P22-198	3/8" B x 3/8" Stem	1.24	1.32	1.38



Straight Barb to Stem

Catalog No.	Description	25+	10+	Each
05P22-103	1/4" B x 1/4" Stem	0.65	0.69	0.73
05P22-117	1/4" B x 5/16" Stem	0.70	0.74	0.78
05P22-102	1/4" B x 3/8" Stem	0.78	0.83	0.87
05P22-106	5/16" B x 3/8" Stem	0.81	0.86	0.90
05P22-190	3/8" B x 5/16" Stem	0.75	0.79	0.83
05P22-101	3/8" B x 3/8" Stem	0.84	0.89	0.94
05P22-128	3/8" B x 1/2" Stem	0.91	0.96	1.01
05P22-100	1/2" B x 3/8" Stem	0.89	0.95	0.99
05P22-129	1/2" B x 1/2" Stem	0.94	1.00	1.04

BARBED END ADAPTS BRAIDED TUBING TO BE COMPATIBLE WITH PUSH-IN FITTINGS

Additional price breaks available on most items. Login to your website account or contact your sales representative for pricing.



BSP Adapter

Catalog No.	Description	25+	10+	Each
05P22-216	1/2" FBSP x 3/8" O.D.	1.52	1.62	1.70
05P22-217	1/2" FBSP x 1/2" O.D.	1.83	1.94	2.04
05P22-213	5/8" FBSP x 5/16" O.D.	1.19	1.27	1.33
05P22-214	5/8" FBSP x 3/8" O.D.	1.65	1.76	1.84



Stop Valve Adapter

Catalog No.	Description	25+	10+	Each
05P22-218	3/8" Comp x 1/4" O.D.	7.23	7.68	8.06
05P22-219	3/8" Comp x 3/8" O.D.	7.83	8.32	8.73



Lock-Out Clip

Catalog No.	Description	25+	10+	Each
05P22-146	1/4" O.D. Tube	0.10	0.11	0.12
05P22-140	3/8" O.D. Tube	0.10	0.11	0.12
05P22-179	1/2" O.D. Tube	0.20	0.22	0.25

John Guest SuperSeal Push-in Fittings



PROVIDES A SECURE SEAL TO METAL TUBING ON ONE END AND SOFT TUBING ON THE OTHER END

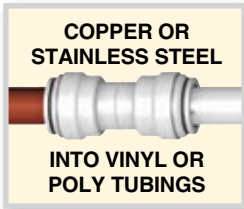

Ref.#	Catalog No.	Description	25+	10+	Each
1	05G01-151	Adapter, 1/4" SS x 1/4" Barb	2.04	2.16	2.27
1	05G01-160	Adapter, 5/16" SS x 1/4" Barb	1.76	1.87	1.96
1	05G01-152	Adapter, 3/8" SS x 1/4" Barb	2.77	2.95	3.09
-	-	-	-	-	-

Ref.#	Catalog No.	Description	25+	10+	Each
2	05G01-172	Union, 5/16" SS x 3/8" OD	2.77	2.95	3.09
2	05G01-135	Union, 3/8" SS x 3/8" OD	2.99	3.18	3.33
3	05G01-170	Elbow, 5/16" SS x 3/8" OD	3.19	3.39	3.56
3	05G01-134	Elbow, 3/8" SS x 3/8" OD	3.69	3.92	4.11

John Guest SpeedFit Push-in Fittings



FOR USE WITH WATER



FOR USE WITH WATER



FOR USE WITH WATER



FOR USE WITH WATER OR CO₂



FOR USE WITH WATER OR CO₂



FOR USE WITH WATER OR CO₂



OTHER JOHN GUEST FITTINGS AVAILABLE UPON REQUEST (Sold in factory package quantities only)

Ref.#	Catalog No.	Description	10+	5+	Each
1	05G01-102	Angled Stop Valve 3/8" C x 1/4" OD	9.25	9.75	10.50
2	05G01-103	Angled Stop Valve 3/8" C x 3/8" OD	9.50	10.00	10.75
3	05G01-104	Compression Adapter 3/8" C x 3/8" OD	5.51	5.86	6.15
4	05G01-105	Angled Stop Valve 3/8" OD for All	12.80	13.55	14.50

Ref.#	Catalog No.	Description	25+	10+	Each
5	05G01-148	Flare Adapter, 1/4" MFL x 1/4" OD	1.22	1.30	1.36
5	05G01-109	Flare Adapter, 1/4" MFL x 3/8" OD	1.99	2.11	2.21
5	05G01-107	Flare Adapter, 5/16" MFL x 5/16" OD	1.33	1.41	1.48
5	05G01-106	Flare Adapter, 5/16" MFL x 3/8" OD	2.19	2.33	2.44
5	05G01-108	Flare Adapter, 3/8" MFL x 3/8" OD	2.25	2.39	2.51
5	05G01-171	Flare Adapter, 1/2" MFL x 3/8" OD	2.97	3.15	3.31
5	05G01-147	Flare Adapter, 1/2" MFL x 1/2" OD	3.06	3.26	3.42
6	05G01-116	Pipe Adapter, 1/8" MPT x 1/4" OD	1.01	1.07	1.13

Brass Push-In Fittings



Swivel Male Pipe Elbow



Swivel Male Pipe Tee

Catalog No.	Description	25+	10+	Each
05B01-400	1/8" MPT x 1/4" O.D.	2.91	3.09	3.24
05B01-401	1/4" MPT x 1/4" O.D.	3.30	3.50	3.68
05B01-402	3/8" MPT x 3/8" O.D.	4.64	4.93	5.17

Catalog No.	Description	25+	10+	Each
05B01-403	1/4" MPT x 1/4" O.D.	3.51	3.73	3.91
05B01-404	3/8" MPT x 3/8" O.D.	8.47	8.97	9.53
05B01-405	1/2" MPT x 1/2" O.D.	11.85	12.55	13.35

1/4" O.D. fits 08H05-154 • 5/16" O.D. fits 08H05-247 • 3/8" O.D. fits 08H05-115 • 1/2" O.D. fits 08H05-116



Poly and Nylon Plastic Fittings

Barbed Fittings

BARB SPLICER



BARB PLUG



BARB ELBOW



BARB TEE



BARB REDUCER TEE



MULTI-FIT

Ref.#	Catalog No.	Description	100+	50+	25+	Each
1	05G01-140	Splicer, 1/4" B x 1/4" B	0.25	0.26	0.28	0.34
1	05G01-143	Splicer, 1/4" B x 3/8" B	0.25	0.26	0.28	0.34
1	05G01-141	Splicer, 3/8" B x 3/8" B	0.25	0.27	0.28	0.34
1	05G01-144	Splicer, 1/2" B x 3/8" B	0.27	0.28	0.30	0.36
1	05G01-163	Splicer, 1/2" B x 1/2" B	0.27	0.28	0.30	0.36
1	05G01-161	Splicer, 5/8" B x 5/8" B	0.35	0.37	0.39	0.48
1	05G01-162	Splicer, 3/4" B x 3/4" B	0.44	0.47	0.49	0.60
1	05G01-142	Splicer, 1" B x 1" B	0.59	0.62	0.65	0.80
2	05G01-101	Plug, (fits 1/4", 3/8", & 1/2" tube)	0.26	0.28	0.29	0.32
3	05G01-145	Elbow, 1/4" B x 1/4" B	0.44	0.47	0.49	0.60
3	05G01-150	Elbow, 1/4" B x 3/8" B	0.79	0.84	0.88	1.07
3	05G01-146	Elbow, 3/8" B x 3/8" B	0.47	0.50	0.52	0.64
3	05G01-153	Elbow, 3/8" B x 1/2" B	0.47	0.50	0.53	0.65
3	05G01-166	Elbow, 1/2" B x 1/2" B	0.47	0.50	0.53	0.65

Ref.#	Catalog No.	Description	100+	50+	25+	Each
3	05G01-164	Elbow, 5/8" B x 5/8" B	0.50	0.53	0.56	0.68
3	05G01-165	Elbow, 3/4" B x 3/4" B	0.68	0.73	0.76	0.93
3	05G01-149	Elbow, 1" B x 1" B	1.01	1.07	1.12	1.37
4	05G01-174	Tee, 1/4" B (All)	0.47	0.50	0.52	0.64
4	05G01-180	Tee, 5/16" B (All)	0.47	0.50	0.53	0.65
4	05G01-181	Tee, 3/8" B (All)	0.51	0.55	0.57	0.70
4	05G01-169	Tee, 1/2" B (All)	0.55	0.59	0.62	0.75
4	05G01-167	Tee, 5/8" B (All)	0.59	0.63	0.66	0.80
4	05G01-168	Tee, 3/4" B (All)	0.64	0.68	0.71	0.87
4	05G01-182	Tee, 1" B (All)	0.74	0.79	0.83	1.01
5	05G01-184	Tee, 1/4" B x 1/4" B x 3/8" B	0.53	0.57	0.59	0.72
5	05G01-183	Tee, 3/8" B x 3/8" B x 1/4" B	0.53	0.57	0.59	0.72
5	05G01-186	Tee, 3/8" B x 3/8" B x 1/2" B	0.54	0.57	0.60	0.73
5	05G01-185	Tee, 1/2" B x 1/2" B x 3/8" B	0.51	0.55	0.57	0.70

Pipe Thread Fittings

PIPE HOSE STEM



PIPE HOSE STEM ELBOW



PIPE UNION



PIPE BUSHING



PIPE PLUG



Ref.#	Catalog No.	Description	100+	50+	25+	Each
6	05G01-110	Stem, 1/4" MPT x 1/4" B	0.27	0.29	0.30	0.37
6	05G01-111	Stem, 1/4" MPT x 3/8" B	0.27	0.28	0.30	0.36
6	05G01-112	Stem, 3/8" MPT x 1/4" B	0.28	0.30	0.31	0.38
6	05G01-113	Stem, 3/8" MPT x 3/8" B	0.29	0.31	0.33	0.40
6	05G01-114	Stem, 3/8" MPT x 1/2" B	0.31	0.32	0.34	0.42
6	05G01-115	Stem, 1/2" MPT x 3/8" B	0.33	0.35	0.36	0.44
6	05G01-119	Stem, 1/2" MPT x 1/2" B	0.31	0.32	0.34	0.42
6	05G01-120	Stem, 3/4" MPT x 1/2" B	0.39	0.41	0.43	0.53
6	05G01-121	Stem, 3/4" MPT x 3/4" B	0.40	0.43	0.45	0.55
7	05G01-122	Elbow, 1/4" MPT x 1/4" B	0.47	0.50	0.53	0.65
7	05G01-123	Elbow, 1/4" MPT x 3/8" B	0.49	0.52	0.54	0.66
7	05G01-124	Elbow, 3/8" MPT x 1/4" B	0.49	0.52	0.54	0.66
7	05G01-126	Elbow, 3/8" MPT x 3/8" B	0.50	0.53	0.56	0.68
7	05G01-127	Elbow, 3/8" MPT x 1/2" B	0.50	0.53	0.56	0.68
7	05G01-128	Elbow, 1/2" MPT x 3/8" B	0.53	0.56	0.59	0.72
7	05G01-129	Elbow, 1/2" MPT x 1/2" B	0.53	0.56	0.59	0.72

Ref.#	Catalog No.	Description	100+	50+	25+	Each
7	05G01-130	Elbow, 3/4" MPT x 1/2" B	0.71	0.75	0.79	0.96
7	05G01-133	Elbow, 3/4" MPT x 3/4" B	0.75	0.79	0.83	1.02
8	05G01-175	Union, 1/4" MPT x 1/4" MPT	0.27	0.29	0.30	0.37
8	05G01-178	Union, 3/8" MPT x 1/4" MPT	0.27	0.29	0.30	0.37
8	05G01-176	Union, 3/8" MPT x 3/8" MPT	-	0.29	0.31	0.33
8	05G01-179	Union, 1/2" MPT x 3/8" MPT	0.31	0.32	0.34	0.42
8	05G01-177	Union, 1/2" MPT x 1/2" MPT	0.32	0.34	0.36	0.43
8	05G01-138	Union, 3/4" MPT x 3/4" MPT	0.44	0.46	0.49	0.59
9	05G01-187	Bushing, 3/8" MPT x 1/4" FPT	0.72	0.76	0.80	0.97
9	05G01-188	Bushing, 1/2" MPT x 3/8" FPT	0.73	0.77	0.81	0.99
9	05G01-189	Bushing, 3/4" MPT x 1/2" FPT	0.88	0.94	0.99	1.20
10	05G01-154	Hex Plug, 1/4" MPT	0.25	0.27	0.28	0.34
10	05G01-155	Hex Plug, 3/8" MPT	0.27	0.28	0.30	0.36
10	05G01-156	Hex Plug, 1/2" MPT	0.30	0.32	0.33	0.41
10	05G01-157	Hex Plug, 3/4" MPT	0.34	0.36	0.38	0.46

Flare Thread Fittings

FLARE ADAPTER



FLARE UNION



FLARE ELBOW



FLARE TEE



Ref.#	Catalog No.	Description	100+	50+	25+	Each
11	05C07-121	Adapter, 1/4" FFL x 1/2"-16 MFL	0.43	0.46	0.48	0.52
12	05C07-103	Union, 1/4" MFL x 1/4" MFL	1.04	1.11	1.16	1.26
12	04E04-205	Union, 1/4" MFL x 1/2"-16 MFL	1.53	1.63	1.70	1.86
12	04E04-207	Union, 1/2"-16 MFL	1.32	1.40	1.47	1.60

Ref.#	Catalog No.	Description	100+	50+	25+	Each
13	04E04-213	Elbow, 1/4" MFL x 1/4" MFL	0.21	0.23	0.24	0.26
13	12C07-200	Elbow, 1/4" MFL x 1/2"-16 MFL	0.87	0.93	0.97	1.06
13	12C07-201	Elbow, 1/2"-16 MFL	1.32	1.40	1.47	1.60
14	04E04-225	Tee, 1/4" MFL (All)	2.46	2.61	2.77	2.90

Plastic Fittings

Colder Products® Quick Couplings



APC Series ACETAL NSF Listed

1/4" nominal flow, PRESSURE: Vacuum to 120 psi, TEMPERATURE: -40° to 180°F



NOT COMPATIBLE WITH THE PLC OR LC SERIES

STRAIGHT HOSE BARB (MALE CONNECTOR)



Catalog No.	Description	50+	25+	10+	Each
05P01-122	1/4" Barb (With Shutoff)	5.50	5.85	6.13	6.68
05P01-176	1/4" Barb (No Shutoff)	1.50	1.59	1.67	1.82
05P01-123	3/8" Barb (With Shutoff)	5.45	5.79	6.07	6.61
05P01-177	3/8" Barb (No Shutoff)	1.50	1.59	1.67	1.82

STRAIGHT HOSE BARB (FEMALE CONNECTOR)



Catalog No.	Description	50+	25+	10+	Each
05P01-120	1/4" Barb (With Shutoff)	5.54	5.88	6.17	6.73
05P01-175	1/4" Barb (No Shutoff)	2.10	2.23	2.34	2.55
05P01-121	3/8" Barb (With Shutoff)	4.50	5.85	6.13	6.68
05P01-154	3/8" Barb (No Shutoff)	2.10	2.23	2.34	2.55

ELBOW HOSE BARB (MALE CONNECTOR)



Catalog No.	Description	50+	25+	10+	Each
05P01-127	1/4" Barb (With Shutoff)	7.13	7.58	7.95	8.66
05P01-181	1/4" Barb (No Shutoff)	1.74	1.85	1.94	2.11
05P01-153	3/8" Barb (No Shutoff)	1.73	1.84	1.93	2.10

MALE PIPE THREAD (FEMALE CONNECTOR)



Catalog No.	Description	50+	25+	10+	Each
05P01-179	1/4" MPT (With Shutoff)	4.76	5.05	5.30	5.78
05P01-178	1/4" MPT (No Shutoff)	3.18	3.37	3.54	3.86
05P01-180	3/8" MPT (With Shutoff)	4.84	5.14	5.39	5.88
05P01-182	3/8" MPT (No Shutoff)	3.21	3.41	3.58	3.90

MALE PIPE THREAD (MALE CONNECTOR)



Catalog No.	Description	50+	25+	10+	Each
05P01-104	1/4" MPT (With Shutoff)	5.80	6.16	6.46	7.04
05P01-103	1/4" MPT (No Shutoff)	1.55	1.65	1.73	1.89
05P01-105	3/8" MPT (No Shutoff)	2.57	2.73	2.87	3.12

FEMALE FLARE THREAD (FEMALE CONNECTOR)



Catalog No.	Description	50+	25+	10+	Each
05P01-131	1/4" FFL (No Shutoff)	4.50	4.78	5.02	5.47

APC SERIES Replacement O-Ring

15E02-102 100+ 0.08 50+ 0.10 Each 0.15

Additional price breaks available on most items. Login to your website account or contact your sales representative for pricing.



HFC35 Series POLYSULFONE NSF Listed

3/8" nominal flow, PRESSURE: Vacuum to 125 psi, TEMPERATURE: -40° to 280°F
Large diameter high flow, chemically resistant



NOT COMPATIBLE WITH THE ALC, PLC OR LC SERIES

STRAIGHT HOSE BARB (MALE CONNECTOR)



Catalog No.	Description	50+	25+	10+	Each
05P01-168	3/8" Barb (With Shutoff)	9.67	10.10	10.73	11.26
05P01-166	3/8" Barb (No Shutoff)	5.99	6.25	6.64	6.97
05P01-152	1/2" Barb (With Shutoff)	9.67	10.10	10.73	11.26
05P01-170	1/2" Barb (No Shutoff)	5.87	6.13	6.51	6.83

STRAIGHT HOSE BARB (FEMALE CONNECTOR)



Catalog No.	Description	50+	25+	10+	Each
05P01-167	3/8" Barb (With Shutoff)	13.53	14.12	15.01	15.74
05P01-165	3/8" Barb (No Shutoff)	CLOSEOUT			11.95
05P01-151	1/2" Barb (With Shutoff)	13.57	14.17	15.06	15.80
05P01-169	1/2" Barb (No Shutoff)	11.43	11.94	12.68	13.31

MALE PIPE THREAD (MALE CONNECTOR)



Catalog No.	Description	50+	25+	10+	Each
05P01-160	3/8" MPT (With Shutoff)	10.57	11.03	11.72	12.30
05P01-164	1/2" MPT (With Shutoff)	10.62	11.09	11.78	12.36
05P01-162	1/2" MPT (No Shutoff)	6.87	7.18	7.62	8.00

MALE PIPE THREAD (FEMALE CONNECTOR)



Catalog No.	Description	50+	25+	10+	Each
05P01-161	1/2" MPT (No Shutoff)	11.59	12.10	12.85	13.49

HFC35 SERIES Replacement O-Ring 05P01-100 100+ .09¢ 50+ .10¢ Each .15¢

Garden Hose Quick Coupling

HFC35 SERIES POLYSULFONE NSF Listed



MALE CONNECTOR

Catalog No.	Description	10+	Each
05P01-125	3/4 FGH (With Shutoff)	8.82	9.37

Quick Couplings



LC Series CHROME PLATED BRASS NSF Listed
 1/4" nominal flow, PRESSURE: Vacuum to 250 psi, TEMPERATURE: -40° to 180°F



COMPATIBLE WITH THE PLC SERIES

STRAIGHT HOSE BARB (FEMALE CONNECTOR)

Catalog No.	Description	50+	25+	10+	Each
04P01-110	1/4" Barb (With Shutoff)	18.88	19.72	20.95	21.98
04P01-138	1/4" Barb (No Shutoff)	18.17	18.97	20.16	21.15
04P01-111	3/8" Barb (With Shutoff)	18.87	19.71	20.94	21.97
04P01-139	3/8" Barb (No Shutoff)	18.04	18.84	20.02	21.00



STRAIGHT HOSE BARB (MALE CONNECTOR)

Catalog No.	Description	50+	25+	10+	Each
04P01-112	1/4" Barb (With Shutoff)	11.84	12.36	13.13	13.78
04P01-106	1/4" Barb (No Shutoff)	5.84	6.21	6.51	7.09
04P01-113	3/8" Barb (With Shutoff)	11.83	12.35	13.12	13.77
04P01-130	3/8" Barb (No Shutoff)	5.66	5.91	6.27	6.58



MALE PIPE THREAD (FEMALE CONNECTOR)

Catalog No.	Description	50+	25+	10+	Each
04P01-133	1/4" MPT (With Shutoff)	12.35	12.90	13.70	14.38
04P01-116	1/4" MPT (No Shutoff)	11.35	11.86	12.60	13.22
04P01-135	3/8" MPT (With Shutoff)	12.35	12.90	13.70	14.38
04P01-134	3/8" MPT (No Shutoff)	11.33	11.83	12.57	13.19



ELBOW HOSE BARB (MALE CONNECTOR)

Catalog No.	Description	50+	25+	10+	Each
04P01-109	1/4" Barb (With Shutoff)	12.07	12.60	13.39	14.05
04P01-117	3/8" Barb (With Shutoff)	11.76	12.28	13.05	13.69



PANEL MOUNT HOSE BARB (FEMALE CONNECTOR)

Catalog No.	Description	50+	25+	10+	Each
04P01-108	1/4" Barb (With Shutoff)	19.13	19.97	21.22	22.26
04P01-137	3/8" Barb (With Shutoff)	19.14	19.98	21.23	22.27
04P01-136	3/8" Barb (No Shutoff)	17.23	17.99	19.12	20.06



PIPE THREAD (MALE CONNECTOR)

Catalog No.	Description	50+	25+	10+	Each
04P01-114	1/4" MPT (With Shutoff)	11.96	12.49	13.27	13.92
04P01-118	1/4" MPT (No Shutoff)	5.71	5.96	6.34	6.65
04P01-120	1/4" FPT (With Shutoff)	12.27	12.81	13.61	14.28
04P01-119	1/4" FPT (No Shutoff)	6.12	6.39	6.79	7.13
04P01-122	3/8" MPT (With Shutoff)	12.56	13.11	13.93	14.61
04P01-121	3/8" MPT (No Shutoff)	6.31	6.59	7.00	7.34



LC AND PLC SERIES Replacement O-Ring

15E02-102 100+ **0.08**
 50+ 0.10 Each 0.15



PANEL MOUNT HOSE BARB (MALE CONNECTOR)

Catalog No.	Description	50+	25+	10+	Each
04P01-127	1/4" Barb (With Shutoff)	15.37	16.05	17.05	17.89
04P01-129	3/8" Barb (With Shutoff)	15.81	16.51	17.54	18.41



Additional price breaks available on most items. Login to your website account or contact your sales representative for pricing.



PLC Series ACETAL NSF Listed
 1/4" nominal flow, PRESSURE: Vacuum to 120 psi, TEMPERATURE: -40° to 180°F



COMPATIBLE WITH THE LC SERIES

IN-LINE HOSE BARB (FEMALE CONNECTOR)

Catalog No.	Description	50+	25+	10+	Each
05P01-156	1/4" Barb (With Shutoff)	5.90	6.27	6.58	7.16
05P01-190	3/8" Barb (With Shutoff)	5.90	6.27	6.58	7.16



IN-LINE HOSE BARB (MALE CONNECTOR)

Catalog No.	Description	50+	25+	10+	Each
05P01-155	1/4" Barb (With Shutoff)	4.72	5.02	5.26	5.73
05P01-185	1/4" Barb (No Shutoff)	1.59	1.69	1.77	1.93
05P01-183	3/8" Barb (With Shutoff)	4.65	4.94	5.18	5.64
05P01-184	3/8" B (No Shutoff)	1.59	1.69	1.77	1.93



MALE PIPE THREAD (FEMALE CONNECTOR)

Catalog No.	Description	50+	25+	10+	Each
05P01-188	1/4" MPT (No Shutoff)	5.60	5.95	6.25	6.80
05P01-189	3/8" MPT (No Shutoff)	5.55	5.90	6.18	6.74



MALE PIPE THREAD (MALE CONNECTOR)

Catalog No.	Description	50+	25+	10+	Each
05P01-191	1/4" MPT (With Shutoff)	6.03	6.41	6.73	7.33
05P01-186	1/4" MPT (No Shutoff)	2.40	2.55	2.67	2.91
05P01-187	3/8" MPT (No Shutoff)	1.89	2.01	2.11	2.29



Colder Products Quick Couplings

Universal Compressors

Embraco-aspera

REPLACES ALL MAJOR BRANDS • ULTRA-QUIET OPERATION • DROP-IN REPLACEMENTS FOR POPULAR MODELS
 LOW "SILHOUETTE" ALLOWING EASY INSTALLATION • DURABLE AND DEPENDABLE CONSTRUCTION • 115 VOLT



**19E11-110
IN STOCK**

OTHER
COMPRESSORS
NOT LISTED ALSO
AVAILABLE

NON-STOCK
COMPRESSORS
SHIP FROM FACTORY
IN NORCROSS, GA



A FULL RANGE OF COMPRESSORS ARE AVAILABLE FOR A WIDE VARIETY OF APPLICATIONS

WHY STOCK DOZENS OF COMPRESSORS WHEN A FEW WILL DO THE JOB?

TO ORDER: Match H.P. and BTU rating ± 10%. (A little low on HP & BTU is better than too much)

Compressors

Embraco R12 Compressors

Catalog No.	Mfg. No	HP	BTU	Temp.	Torque	HBP/LBP	Pallet/80 Not Boxed	Pallet/15 Boxed	6+	3+	Each
19E11-138	FF10BK	1/4	913/3244	Low	Normal	HBP/LBP	84.95	142.95	-	-	165.95
19E11-100	FF112BX	1/3	1350/4150	Low	High	HBP/LBP	93.95	164.95	-	-	190.95

Aspera R134A Compressors

Catalog No.	Mfg. No	HP	BTU	Temp.	Torque	HBP/LBP	Pallet/14 Not Boxed	Pallet/11 Boxed	6+	3+	Each
19E11-142	B6170Z	1/4	3206	High	Normal	HBP	188.95	-	-	-	218.95
19E11-112	T6213Z	1/2	5892	High	High	HBP	-	278.95	-	-	322.95

Embraco R134A Compressors

Catalog No.	Mfg. No	HP	BTU	Temp.	Torque	HBP/LBP	Pallet/80 Not Boxed	Pallet/15 Boxed	6+	3+	Each
19E11-145	FF10HBK	1/4+	840/3530	Low	Normal	HBP/LBP	95.95	160.95	-	-	185.95
19E11-146	FF10HBX	1/4+	840/3530	Lo/Med/Hi	High	HBP/LBP	98.95	165.95	-	-	191.95
19E11-110	FF112HBX	1/3	1170/4300	Lo/Med/Hi	High	HBP/LBP	97.95	116.95	119.95	122.95	125.95

Universal Condenser Fan Motors

FOR BEVERAGE COOLERS, WATER COOLERS, ICE MAKERS, VENDING MACHINES, REFRIGERATORS, FREEZERS & MORE

- Versatile mounts for multiple applications
- Designed for quiet continuous operation
- Cast iron frame, 22" 18 gauge twin leads
- Works for 2 or 4 flange mounting



1/4" – 20 Threaded shaft • 4 pole, 115V 60/50hz

SEE PAGE 142 FOR SQUARE FAN MOTORS

Aluminum Fan Blades for Fan Motors

Catalog No.	Diameter	Each
19R02-110	7"	8.95
19R02-111	8"	12.95
19R02-113	10"	11.95



Catalog No.	Watts	24+	12+	6+	Each
19R02-101	4	22.95	23.95	24.95	25.95
19R02-102	6	21.95	22.95	23.95	24.95
19R02-103	9	20.95	21.95	22.95	23.95

Additional price breaks available on most items. Login to your website account or contact your sales representative for pricing.

Agitator Motors FOR ALL MODEL ICE BANK COOLING UNITS



BEFORE BUYING, CHECK FOR:

- Rotation & watts (stamped into face-plate)
- Shaft length & blade mount
- All fan blades are sold separately

INCLUDES
11pc #8-36
mounting screws

MOTOR DIMENSIONS:
3-25/32" Diameter
3-9/64" Wide

Catalog No.	Rotates	Output	Shaft Length	Volts	4+	2+	Each
19Q06-106	CCW	15w	5"	115	CLOSEOUT 45.95		
19Q06-108	CCW	15w	7"	115	82.95	84.95	86.95

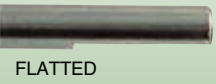

Uses Pin	Each
19E03-101	0.25
19E03-102	0.25
19E03-102	0.25
19E03-102	0.25

Catalog No.	Rotates	Output	Shaft Length	Volts	4+	2+	Each
19Q06-101	CW	15w	8.5"	115	75.95	77.95	79.95
19Q06-104	CCW	15w	7"	115	72.95	75.95	77.95
*19Q06-107	CCW	25w	7"	115	74.95	76.95	78.95
*19Q06-114	CCW	25w	7"	230	81.95	83.95	86.95

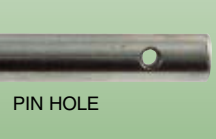

Catalog No.	Description	Each
19Q06-112	Washer	0.45
19Q06-110	Nut	0.30

* MULTIPLEX

Catalog No.	Rotates	Output	Shaft Length	Volts	4+	2+	Each
**19Q06-103	CCW	15w	5"	115	72.95	75.95	77.95
**19Q06-105	CCW	15w	7"	115	74.95	76.95	78.95



** CORNELIUS

Replacement Blades

Ref.#	Catalog No.	Fits Shaft	Each
1	19A01-201	Flatted	2.00
2	19C07-107	Pin Hole	5.38
3	19Q06-111	Threaded	9.50
4	19Q06-109	All	2.41



Universal Fan Motor

MULTI-PURPOSE

- For condenser & evaporator use
- Blade is 4" diameter
- 120V / .5A / 60Hz reversible motor

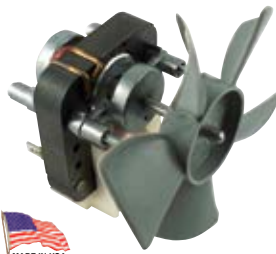

Catalog No.	Description	6+	3+	Each
19T05-102	Fan Motor/Blade	17.95	18.95	19.95
17F09-142	Mounting Bracket	4.75	5.00	5.25

Submersible Agitator Pumps



MULTI-PURPOSE APPLICATION



- Ball bearings perm lubed
- Overload protected
- Durable all steel gear



Catalog No.	GPH	Outlet	Each
09B04-108	210	1/4" NPT	42.95
09B04-105	325	1/4" NPT	45.95

Portable Cold Controls

CREATE KEGERATORS & FERMENTATION CHAMBERS • WORKS WITH REFRIGERATORS OR FREEZERS



Mechanical Cold Control

SIMPLE TO USE:
Plug into wall and place sensor into refrigerator/freezer, plug refrigerator/freezer into cold control and adjust temp.

- FEATURES:**
- Range: +20°F to +80°F
 - Differential: 4°F
 - Rotary dial adjustment
 - Gas-filled sensor on a 6' capillary tube
 - 6' Power cord

Johnson Controls

19W09-100

6+ \$50.95 3+ \$52.95 Ea. \$54.95



Digital Cold & Heat Control

SIMPLE TO USE:
Plug into wall and place sensor into refrigerator/freezer, plug refrigerator/freezer into cold control and adjust temp.

- FEATURES:**
- Range: -40°F to +212°F
 - Differential: Adj. 1° to 30°F
 - 3-Button touch-pad
 - Gas-filled sensor on a 8' flexible cable

Johnson Controls

19W09-102

6+ \$73.95 3+ \$76.95 Ea. \$79.95

Ice Bank Control



RANCO #1860074001

- Replacement for several IMI Cornelius Ice/drink dispensers and ice machines
- 72" capillary tube with bulb sensor

RANCO

19S05-133

6+ \$64.95 3+ \$67.95 Ea. \$70.95



RANCO #018-100

- Replacement for several Manitowoc Ice/drink dispensers and ice machines
- 76" capillary tube with bulb sensor

RANCO

19S05-101

6+ \$90.95 3+ \$94.95 Ea. \$98.95

Cold Control for Beverage-Air® Units

GENUINE OEM REPLACEMENT PART



19B02-116

12+ \$29.95

- Robertshaw #502-290B
- Temp range 11.4° to 50.6° F
- Capillary / sensor length 27"
- Works with most Beverage-Air dispensers and cooling units

Robertshaw

6+ \$28.95 3+ \$33.95 Ea. \$35.95

Universal Cold Control



RANCO #A30-261

- Range: +32° to +61°F
- Differential: 6°F
- Full load rating: 20 amp at 120/240 VAC
- Includes: various mounting/install hardware
- 84" capillary/tube sensor

RANCO

19S05-110

6+ \$46.95 3+ \$48.95 Ea. \$50.95

Universal Cold Control



RANCO #A30-2210

- Range: +30° to +43°F
- Differential: 8°F
- Full load rating: 20 amp at 120/240 VAC
- Includes: face plate
- 48" capillary/tube sensor

RANCO

19S05-124

6+ \$50.95 3+ \$52.95 Ea. \$54.95

Aluminum Condensate Drain

Removes condensation from refrigeration equipment, vending machines, reach in coolers and more.

- Cast aluminum
- 38 oz. capacity
- Evaporation rate 8 oz./hour
- 120V / 160 Watt



10" L x 4" W x 2 7/8" H

19H07-105

4+ \$45.95 2+ 47.95 Ea. 50.95



Condensate Removal Pump

Use on beverage dispensers, ice machines drinking fountains, water coolers and more.

MODEL CB151UL



- 17' maximum lift / 120 gph @ 1' lift
- Thermal overload protection
- Dual float design increases reliability
- Patented air cooling for longer life
- Fully automatic with safety switch
- 3/8" B or 1/4" MPT discharge tube w/check valve
- 6' 3-prong power supply cord
- 2 quart capacity tank
- 115V/60Hz
- 1 year limited warranty
- 6-1/4"H x 5"W x 11-1/8"L



19B04-100

4+ \$39.95 2+ \$41.95 Ea. \$43.95

Digital Wey-Tek™ Charging Scale

Wey-Tek™ features

- Durable cast aluminum weighing platform
- Measures in lbs./ozs., kgs or decimal lbs.
- Large LCD for easy viewing, even in direct sunlight
- Auto shut-off after 30 min. conserves battery
- High-accuracy load cell won't drift
- Automatic and manual zeroing (taring)
- Hard plastic carrying case included
- 2 year replacement warranty



19A11-101 \$199.95



Test/Charge Manifold

INCLUDES VACUUM & CHARGING HOSES 3' SET

- R-22/R-404A/R-134A
- Color coded gauge boots
- Durable unit brass manifold with metal handles
- Quick action valve 1/2 turn open/close
- Lifetime warranty on manifold



20R08-101 Ea. \$64.95

Starter/Relay THE BIG RELAY

For all compressors rate 1/12 to 1/2 hp

- Prevents low voltage starting problems
- Provides added boost for hard start or unbalanced systems

19S02-103
3+ \$15.95 Ea. \$16.95



RSC SERIES

Blowout Kit with 6' Hose

Attaches directly to CO2 cylinder. Blows dirt out of refrigeration condensers in seconds. Stops premature failure of refrigeration condensers.

CAUTION: TURN ON CO2 SLOWLY!



Catalog No.	Description	25+	10+	Each
02D03-141	Blowout Hose 6'	5.95	6.25	6.50
04E04-391	Fitting only	3.75	-	3.95

Additional price breaks available on most items. Login to your website account or contact your sales representative for pricing.

Fin Comb Set

Straighten and clean evaporator and condenser fins with these tough, durable nylon combs.

- Color coded for easy identification
- Includes 6 heads and 1 handle
- For 8 through 14 fins per inch.

19R06-140 Ea. \$10.50



Leak Detector IRIDESCENT LIQUID

- Clings to area where applied.
- Iridescence helps pinpoint slightest leak.
- For use with compressed gases.

8 fl. oz./ case of 24

Catalog No.	24+	12+	Each
19R06-118	6.50	6.95	7.50



Ice Machine Cleaner NICKEL SAFE

- Concentrated formula, low foaming
- Environmentally friendly
- Low odor

16 oz. / case of 6

16 OZ BOTTLE			
Catalog No.	12+	6+	Each
20G05-128	8.95	9.50	9.95
1 GALLON JUG			
Catalog No.	12+	8+	4+
*20G05-129	27.95	29.95	30.95

* Hazardous shipping fee



Evaporator/Condenser/Coil/Fin Cleaner SELF RINSING • FAST ACTING • FOAMING ACTION

- Penetrating and foaming action float away soils and grease
- Evaporator coils need no rinsing if applied in place to a functioning unit that produces moisture
- It is only necessary to rinse units that have been removed for repairs or do not produce moisture during operation
- 15 oz. / case of 12



Catalog No.	12+	6+	Each
20D08-216	3.95	4.25	4.50



Refrigeration Access Valves

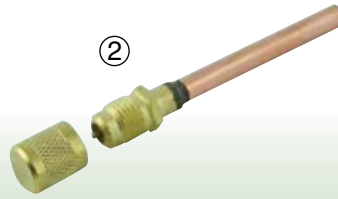

Ref.#	Catalog No.	Description	12+	6+	Each
1	19R06-132	1/4" OD Tube x 1/4" MFL	2.85	2.89	3.00
2	19R06-104	1/4" OD Tube x 1/4" MFL	1.80	1.90	2.00

Ref.#	Catalog No.	Description	12+	6+	Each
2	19R06-106	3/8" OD Tube x 1/4" MFL	2.01	2.10	2.25
3	19R06-114	Univ. 1/4, 5/16, 3/8" x 1/4" MFL	3.75	3.95	4.25

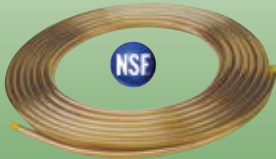

Copper Tubing

Designed specifically for water lines. Economy priced. Flexible and easy to work. .024 Wall. Priced per 50' Coil.

Catalog No.	O.D. Size	20+	10+	5+	Each
05D05-101	1/4"	28.95	29.95	30.95	31.95
05D05-102	3/8"	40.95	41.95	42.95	44.95
05D05-110	1/2"	55.95	57.95	58.95	61.95

Copper Filter Driers

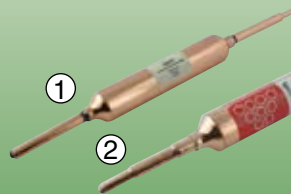

2

- 100% molecular sieve
- Hermetically sealed
- Copper shells and end tubes
- High capacity
- Easy break-off grooved ends

Ref.#	Catalog No.	Capacity in Tons	10+	5+	Each
1	19R06-121	1/3 to 1/2 Ton	2.95	3.25	3.50
2	19R06-120	1/2 to 3/4 Ton	4.25	4.50	4.95

Additional price breaks available on most items. Login to your website account or contact your sales representative for pricing.

Dial Thermometer

- 1" head diameter with zero reset adjustment.
- 5" stainless steel probe
- Polycarbonate crystal.



Catalog No.	Description	24+	12+	Each
20K04-105	Hot drinks 0° to 220°F	2.52	2.78	2.95
Catalog No.	Description	12+	6+	Each
20K04-103	Cold drinks -40° to 160°F	3.31	3.61	3.98

Digital Thermometers

- Easy-to-read LCD display
- On/off button, auto power off
- -40° to 300°F temp range
- 1.0% over full scale accuracy



20K04-109 24+ **\$9.86** 12+ \$10.36 Ea. \$11.45

- Easy-to-read LCD display
- On/off button
- -50° to 300°F temp range
- Auto power off



20K04-107 Ea. **\$22.95**

Spirit Thermometer

- Magnifying lens for easy-to-read temperature
- Red against white column



Catalog No.	Description	Each
20K04-102	Cold drinks -40° to 120°F	6.45



Infrared Units



INF165C

- -76° to 1022°F range
- 12:1 Distance to spot ratio
- 2 Emissivity levels (.70, .95)
- Max value capture
- Auto off



20K04-155
\$50.95



INF195C

- -76° to 1022°F range
- 12:1 Distance to spot ratio
- 3 Emissivity levels (.30, .70, .95)
- MIN/MAX differential, average
- Hi/Low alarm (user adjustable)



20K04-185
\$98.95



Digital Thermometer

PROFESSIONAL GRADE

- -40° to 1,000°F temp range
- ± 2° accuracy
- 4' coiled probe cord
- Water resistant
- Easy-to-clean keypad

20K04-210 **\$168.95**





T-Handle Cylinder Locks

THE INDUSTRY'S FINEST – ROCK SOLID SECURITY

Fits most T-Handles on the market

- Flat faced locking mechanism resists drilling, picking and prying
- Built to order only—with highly secure and registered combinations
- Quality construction for accurate fit, durability and dependability



KEY
CHOICE OF ELEVEN IDENTIFICATION COLORS

SHIPS DIRECTLY FROM MANUFACTURER

Catalog No.	Description	25+	10+	Each
17N04-134	Lock	12.25	12.95	13.95
17N04-140	Key	6.25	6.82	7.26

Combination Lock RESETABLE COMBINATION



- 10,000 combinations
- Hardened stainless steel shackle
- Reset combination any time you need
- 2" width, 1" shackle clearance



17N07-101
Ea. **\$16.95**

Brass Padlocks - 4140

KEYED ALIKE - SOLD IN 12PC MULTIPLES

Product Features

- 1-1/2" (38mm) wide brass body provides resistance to the elements
- 13/16" shackle clearance
- Hardened steel shackle provides excellent cut resistance
- Non-rekeyable, 4-pin tumbler cylinder provides excellent pick resistance



RANDOM KEY PATTERN FOR EVERY ORDER UNLESS A CODE (STAMPED ON KEY) IS PROVIDED



17N08-107 Ea. **\$7.50**

SOLD IN 12PC MULTIPLES

Additional price breaks available on most items. Login to your website account or contact your sales representative for pricing.

Brass Padlocks - 4150 Master Lock

KEYED ALIKE - SOLD IN 6PC MULTIPLES

Product Features

- 1-7/8" (48mm) wide brass body provides resistance to the elements
- 15/16" shackle clearance
- Hardened steel shackle provides excellent cut resistance
- Non-rekeyable, 5-pin tumbler cylinder provides excellent pick resistance



RANDOM KEY PATTERN FOR EVERY ORDER UNLESS A CODE (STAMPED ON KEY) IS PROVIDED



SOLD IN 6PC MULTIPLES 17N08-109 Ea. **\$8.95**

Eddy Products Heat Gun

PROFESSIONAL GRADE - INDUSTRIAL QUALITY

MARK IV

- Temperature range 500-750° F
- 3 position switch (COLD / HOT / OFF)
- 27 CFM air volume at 3300 FPM velocity
- Long-life heat element
- 115V, 12 amp, 1440 watt
- Weighs under 3 lbs.



Includes adjustable hands-free stand

20T08-121 Ea. **\$78.95**

Cleaning Cards

CARD READER

keeps reader functioning properly. Improves overall performance. Saves time and money.



DOLLAR BILL
Cleans, lubricates and protects all gaming, amusement and vending machines.



Catalog No.	Description	100+	50+	25+	Each
19H08-103	Dollar Bill	1.16	1.25	1.30	1.45
19H08-104	Card Reader	1.29	1.37	1.44	1.57

Pocket Multi-Tester

MEASURES AC & DC VOLTS, DC MILLIAMPS, OHMS

FEATURES

- 16 MEASURING RANGES
- AC VOLTS: 0-10, 50, 250, 500
- Measures line and control voltage.
- DC VOLTS: 0-10, 50, 250, 500
- DC MILLIAMPS: 0-250
- OHMS: 0-200K



20R09-196 **\$13.95**



"Brute" Appliance Hand Trucks

WITH V-BELT STAIR CLIMBERS & EASY-ROLL RETRACTABLE REAR WHEELS

Move up to 1600 lbs. with ease • Ideal for large vending machines



**DUAL BELTS
WITH OFFSET
ARM TIGHTENER**

AVAILABLE OPTIONS

72" or 78" Height
4" or 8" Top Plate
Safety Brake
Red or Blue color

- 10" Mold-on rear wheels
- 5" Mold-on front wheels
- 2 pc. 14' length straps
- 24" W x 72" H or 78" H

72" WEIGHS 105 LBS.
78" WEIGHS 111 LBS.



Catalog No.	Height	Safety Brake	Toe Plate	Color	Each
14M06-103	72"	No	4"	Blue	581.95
14M06-106	72"	No	4"	Red	581.95
14M06-144	72"	No	8"	Blue	627.95
14M06-120	72"	Yes	4"	Blue	740.95
14M06-137	72"	Yes	4"	Red	740.95
14M06-104	78"	No	4"	Blue	598.95
14M06-147	78"	No	8"	Red	643.95
14M06-121	78"	Yes	4"	Blue	757.95
14M06-123	78"	Yes	4"	Red	757.95
14M06-141	78"	Yes	8"	Blue	802.95

Replacement Parts

Catalog No.	Description	Each
14M06-112	5" Mold-On Front Wheel	22.95
14M06-132	Ball Bearing 5/8" (fits 14M06-112)	3.24
14M06-113	10" Mold-On Rear Wheel	58.95
14M06-133	Ball Bearing 1" (fits 14M06-113)	5.53
14M06-114	Stair Climber Assy (1 pc)	27.95
14M06-115	Rubber Bumper Strip (per ft.)	2.48
14M06-117	14' Replacement Strap	23.95
14M06-200	Axle (fits 5" Wheel)	9.50
14M06-201	Yoke (for wheel release)	6.95
14M06-202	Offset Handle	23.95
14M06-122	Rubber Bumper 2" wide (per ft.)	2.86

"Brawny Brute" Appliance Hand Trucks

WITH V-BELT STAIR CLIMBERS. EASY-ROLL RETRACTABLE REAR WHEELS & A SAFETY BRAKE

Move up to 1600 lbs. with ease • Ideal for large vending machines

Visit: www.foxxequipment.com for photos of replacement parts



**OVER-THE-TOP
WITH OFFSET
ARM TIGHTENER**

AVAILABLE OPTIONS

72" or 78" Height
4" or 8" Top Plate
Red or Blue color

- 10" Mold-on rear wheels
- 5" Mold-on front wheels
- Safety brake
- 24" W x 72" H or 78" H

72" WEIGHS 105 LBS.
78" WEIGHS 111 LBS.



Catalog No.	Height	Safety Brake	Toe Plate	Color	Each
14M06-101	72"	Yes	4"	Blue	700.95
14M06-102	72"	Yes	4"	Red	700.95
14M06-145	72"	Yes	8"	Blue	745.95
14M06-134	78"	Yes	4"	Blue	744.95
14M06-139	78"	Yes	8"	Blue	789.95
14M06-146	78"	Yes	8"	Red	789.95

Replacement Parts

Catalog No.	Description	Each
14M06-112	5" Mold-On Front Wheel	22.95
14M06-132	Ball Bearing 5/8" (fits 14M06-112)	3.24
14M06-113	10" Mold-On Rear Wheel	58.95
14M06-133	Ball Bearing 1" (fits 14M06-113)	5.53
14M06-114	Stair Climber Assy (1 pc)	27.95
14M06-115	Rubber Bumper Strip (per ft.)	2.48
14M06-116	L-Arm and Replacement Strap	56.95
14M06-129	Rubber Bumper (fits L-Arm)	5.98
14M06-200	Axle (fits 5" Wheel)	9.50
14M06-201	Yoke (for wheel release)	6.95
14M06-203	Offset Handle	23.95
14M06-122	Rubber Bumper 2" wide (per ft.)	2.86



"Big Wheel" Appliance Truck



700 LB. CAPACITY
WITH LABOR SAVING STAIR CLIMBERS

- 8-1/2" solid rubber tires.
 - Offset handle belt tightener
 - 4" nose plate
 - 58-1/4" H x 23" W
- WEIGHS 58 LBS.**



14M06-143 **\$226.95**

Combo Keg/Hand Truck



700 LB. CAPACITY

WORKS WITH 1/2, 1/4, 1/6 BARREL STRAIGHT SIDE KEGS

- 10" x 2.75" semi-pneumatic tires.
 - Hook rotates sideways for hand truck use.
 - 8" deep nose plate
 - 48" H x 19-3/4" W
- WEIGHS 42 LBS.**



Movable hook locks onto keg



14W06-100 **\$239.95**

Additional price breaks available on most items. Login to your website account or contact your sales representative for pricing.

Light Duty Dual Trucks

ROLL-OR-KARI

PERFECT FOR MOVING MOST VENDING MACHINES



Each strap is 7'

Replacement Strap Set (4 pc)
14E06-103 Set
\$32.95

Different length strap sets available — Call for pricing



Replacement Swivel Caster

14E06-102

4+ **\$18.95** Ea. **\$19.95**

STEP LIFT SYSTEM
1,000 LB. CAPACITY

- 1" lift height
- 3-1/2" casters
- Oak and metal construction
- Fold-out handles
- 32" H x 23" W

WEIGHS 55 LBS.



BEST SELLER

14E06-101 **\$437.95**

Medium Duty Dual Trucks



1,320 LB. CAPACITY

MANUAL CRANK LIFT SYSTEM

- 12" lift height
- 6" mold-on polyurethane wheels
- All metal construction
- 32" H x 23" W

WEIGHS 55 LBS.



PERFECT FOR MOVING MOST VENDING MACHINES

14W06-126 **\$679.95**

Heavy Duty Dual Trucks



3,950 LB. CAPACITY

HYDRAULIC LIFT SYSTEM

- 10" lift height
- 6" mold-on polyurethane wheels
- All metal construction
- 42" H x 26-1/2" W

WEIGHS 190 LBS.

PERFECT FOR MOVING MOST VENDING MACHINES



14W06-125 **\$944.95**



Cylinder Trucks

Single Swing-Out

800 LB. CAPACITY

- Step-latch releases tilt support
- Gravity lock secures for easy transport
- 8" mold-on rubber wheels
- 3" swivel casters
- 42" H x 22-1/2" W
- 35" H on tilt



WEIGHS 34 LBS.

14M06-118 **\$192.95**



Dual Kick-Off

540 LB. CAPACITY

- Easily unload cylinders with foot controlled kick plate system
- 10" pneumatic wheels with precision bearings
- 48-1/2" H x 23" W



WEIGHS 48 LBS.

14M06-119 **\$216.95**



Additional price breaks available on most items. Login to your website account or contact your sales representative for pricing.

WESCO® 2-in-1 Hand Trucks

DURABLE, LIGHTWEIGHT ALUMINUM FRAME & NOSEPLATE

Spartan Jr. Aluminum



500 LB. CAPACITY (2 wheel)
1,000 LB. CAPACITY (4 wheel)

- 10" pneumatic wheels
- 5" swivel casters
- 52" H (12" x 38" frame bed)

WEIGHS 38 LBS.

14W06-123 **\$277.95**

Spartan Sr. Aluminum



500 LB. CAPACITY (2 wheel)
1,000 LB. CAPACITY (4 wheel)

- 10" pneumatic wheels
- 5" swivel casters
- 61-1/2" H (12" x 51" frame bed)

WEIGHS 41 LBS.

14W06-124 **\$287.95**

Economy Green Line Steel



300 LB. CAPACITY (2 wheel)
400 LB. CAPACITY (4 wheel)

- 8" semi-pneumatic wheels
- 3" swivel casters
- 48" H (13" x 36" frame bed)

WEIGHS 37 LBS.

14W06-104 **\$171.95**

Aluminum Hand Truck



600 LB. CAPACITY

- 8" mold-on rubber wheels
- Continuous bent-back handle
- All aluminum heavy-duty construction
- 49" H x 18" W

WEIGHS 20 LBS.

14W06-109 **\$172.95**



"Big Wheel" Hand Truck



700 LB. CAPACITY

- 8" easy-roll ball bearing wheels with semi-pneumatic tires
- Open nose plate with beveled edge
- Stair climbers with flatted surface helps prevent damage
- 55" H x 17-1/2" W

WEIGHS 35 LBS.

14M06-111 **\$121.95**



Winch Unit



500 LB. CAPACITY

- 20" x 20" platform
- 54" lift height
- Auto-Brake
- Casters with wheel locks
- 70-1/2" H x 20" W



WEIGHS 103 LBS.

14W06-101 **\$759.95**

Pallet Truck



5,500 LB. CAPACITY

- 8" nylon steering wheels with 3" load wheels
- Adjustable fork connecting rods
- Reinforced 7" wide forks
- 3 year pump warranty
- 3" lowered fork height / 8" raised fork height

WEIGHS 200 LBS.

14W06-120 is 21" FORK WIDTH
14W06-121 is 27" FORK WIDTH

\$418.95 DROP SHIP ONLY

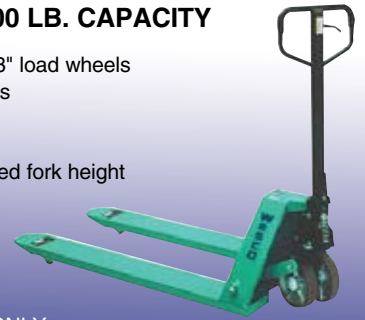

6-Wheel Stocking Cart



1,400 LB. CAPACITY

- Two 8" mold-on rubber wheels
- Four 5" non-marking casters
- 1" diameter tube construction
- 54" L x 18" W x 40" H

WEIGHS 69 LBS.



14M06-142 **\$270.95**

Superlite Folding Truck



175 LB. CAPACITY

- Aluminum/plastic construction
- Elastic cord to secure load
- 7" rubber non-marking wheels
- 42" H x 19" W x 12" Nose plate
- Compacted size
29-1/2" H x 19" W x 2" D

WEIGHS 8-1/2 LBS.

14W06-111 **\$136.95**



Additional price breaks available on most items. Login to your website account or contact your sales representative for pricing.

Heavy-Duty Curb Ramps

4+ **\$77.95**

2+ **\$80.95** Ea. **\$85.95**

- Weighs only 7 lbs.
- Portable with carry handle
- Maximum capacity of 600 lb.
- 23.5" L x 21.5" W x 6" H



14W06-114



14W06-113

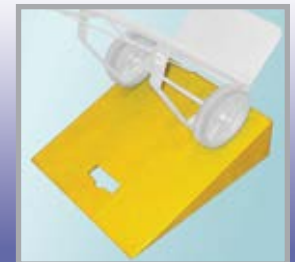

14W06-112

Universal Replacement Wheels and Casters

①



②



③



④



⑤



⑥



Ref. #	Catalog No.	Wheel Dimension	Wheel Type	Axle Diameter /Type	Hub Length	4+	2+	Each
1	14M06-112	5" x 2"	Mold-on Rubber – Aluminum Core	5/8" Ball Bearing	2" offset	20.95	21.95	22.95
2	14M06-127	8" x 1-5/8"	Mold-on Rubber – Aluminum Core	5/8" Ball Bearing	2" centered	29.95	31.95	33.95
3	14M06-113	10" x 2-1/2"	Mold-on Rubber – Aluminum Core	1" Ball Bearing	2-7/8" centered	52.95	55.95	58.95
4	14M06-125	10" x 2-3/4"	Semi-pneumatic – Plastic Core	5/8" Ball Bearing	2-1/4" offset	16.95	17.95	18.95
5	14M06-126	3.50/4.10.4	Full-pneumatic – Metal Core	5/8" Ball Bearing	2-1/4" offset	24.95	25.95	26.95
6	14M06-131	5" x 1-1/4"	Hard Rubber – Swivel Caster	Bolt Hole Pattern	1-3/4" x 2-7/8"	11.95	12.95	13.95



LEATHERMAN® Multi-Tools

Keychain Size Tools



6
TOOLS
IN ONE

STYLE CS KEYCHAIN TOOL
20L05-136 \$20.95



8
TOOLS
IN ONE

STYLE PS KEYCHAIN TOOL
20L05-137 \$23.95



13
TOOLS
IN ONE

SQUIRT ES4 KEYCHAIN TOOL
20L05-138 \$27.95



9
TOOLS
IN ONE

KEYCHAIN TOOL
20L05-139 \$27.95

Full Size Tools



7
TOOLS
IN ONE

SKELETOOL POCKET TOOL
20L05-127 \$51.95

← WITH
POCKET
CLIP →



14
TOOLS
IN ONE

WINGMAN FULL SIZE TOOL
20L05-105 \$42.95



17
TOOLS
IN ONE

REBAR FULL SIZE TOOL
20L05-123 \$51.95

Full Size Tools



19
TOOLS
IN ONE

SUPERTOOL FULL SIZE TOOL
20L05-122 \$65.95



17
TOOLS
IN ONE

WAVE FULL SIZE TOOL
20L05-117 \$73.95



21
TOOLS
IN ONE

SURGE FULL SIZE TOOL
20L05-129 \$90.95



19
TOOLS
IN ONE

CHARGE ALX FULL SIZE TOOL
20L05-128 \$103.95

Leatherman Tools





Cobra and Alligator Pliers

QUALITY TOOLS FOR THE PROFESSIONAL



①

18 POSITION
1.5" CAPACITY

②

25 POSITION
2" CAPACITY

SELF-LOCKING
ON ALL SHAPES OF
PIPE AND NUTS



③

9 POSITION
2" CAPACITY

④

9 POSITION
2.75" CAPACITY



COBRA PLIERS

Easy push button adjustment with fine adjustment



ALLIGATOR PLIERS

Non-slip adjustment now with 30% more capacity

- Tungsten vanadium steel forgings for exceptional strength, durability and light weight
- Patented parallel jaw design works well on round, hex and square shaped workpieces
- Thin profile allows better access in confined areas

Ref.#	Catalog No.	Description	6+	3+	Each
1	20G08-149	7" Cobra	35.95	37.95	38.95
2	20G08-148	10" Cobra	37.95	38.95	40.95
3	20G08-150	10" Alligator	27.95	28.95	30.95
4	20G08-151	12" Alligator	42.95	43.95	45.95

Additional price breaks available on most items. Login to your website account or contact your sales representative for pricing.



WILDE
TOOL

High Quality Pliers and Handtools

PRODUCING PROFESSIONAL GRADE HAND TOOLS FOR OVER 75 YEARS



The quality remains long after the price paid is forgotten



①

THIN TIPS
FIT WHERE
MOST WON'T

6" THIN NOSE
LOBSTER CLAW PLIER



②

INCLUDES
WIRE
CUTTERS

6" STANDARD
LOBSTER CLAW PLIER



③

INCLUDES
WIRE
CUTTERS

10" STANDARD
LOBSTER CLAW PLIER

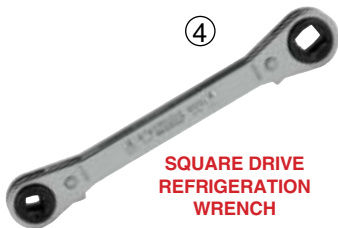

④

SQUARE DRIVE
REFRIGERATION
WRENCH

3/8", 5/16", 1/4", 3/16"
SQ. DR. RATCHET WRENCH



⑤

JAW OPENS
TO
2-1/8"

10" SMOOTH JAW
ANGLE-NOSE PLIER



⑥

JAW OPENS
TO
2-1/8"

11" ANGLE NOSE
SLIP-JOINT PLIER



⑦

PERFECT
FOR CYLINDER
SNAP RINGS

9" 90° TIP (.115)
RETAINER-RING PLIER

Ref.#	Catalog No.	Description	6+	3+	Each
1	20R09-203	6" Thin Nose Plier	12.95	13.95	14.95
2	20R09-206	6" Standard Plier	11.50	11.95	12.50
3	20R09-207	10" Standard Plier	15.50	15.95	16.95
4	20R06-116	Sq. Dr. Ratchet Wrench	10.95	11.50	11.95

Ref.#	Catalog No.	Description	6+	3+	Each
5	20R09-208	10" Smooth Jaw Plier	14.50	14.95	15.95
6	20R09-204	11" Angle Nose Plier	16.50	16.95	17.95
7	20R09-170	Snap Ring Plier (90° .115 tips)	17.95	18.95	19.95



Professional Grade Hand Tools

HIGH QUALITY TOOLS FOR THE SERVICE PROFESSIONAL

Tools (General Hand)



ALSO
CRIMPS AND CUTS
SMALL BOLTS

WIRE STRIPPER/CUTTER
10 to 20 GAUGE WIRE

Catalog No.	6+	3+	Each
20R09-292	18.50	19.25	19.95



FOR
RELIABLE
EVERYDAY USE

6 PC SCREWDRIVER SET
BASIC SLOTTED/PHILLIPS SIZES

Catalog No.	6+	3+	Each
20M04-207	17.95	18.95	19.95



S.A.E.
12 PC
1/16" TO 5/16"



METRIC
9 PC
1.5 TO 10

BALL/HEX "L" WRENCH SETS
TURNS 360° UP TO A 35° ANGLE

Type	Catalog No.	6+	3+	Each
S.A.E.	20M04-203	14.50	14.95	15.50
Metric	20M04-205	17.95	18.95	19.95



LONG LASTING
SUPERIOR
CUTTING EDGE

6" DIAGONAL CUTTER
CUTS SOFT OR HARD WIRES

Catalog No.	6+	3+	Each
20R09-301	20.95	21.95	22.95



CROSSHATCH
TEETH PATTERN
PROVIDES RELIABLE GRIP

6" NEEDLE NOSE PLIER
WITH SIDE WIRE CUTTER

Catalog No.	6+	3+	Each
20R09-294	21.95	22.95	23.95



SUPERIOR QUALITY
PROVIDES RELIABLE GRIP

PRECISION ADJUSTABLE WRENCH
8" OR 10" MODEL

Type	Catalog No.	6+	3+	Each
8"	20R09-291	12.95	13.50	13.95
10"	20R09-289	15.95	16.95	17.95



INDUSTRIAL
QUALITY



MIDGET TUBING CUTTER
3/16" to 15/16" DIAMETERS

Catalog No.	6+	3+	Each
20M04-204	21.95	22.95	23.95



INDUSTRIAL
QUALITY
NO-SLIP GRIP

FLARING TOOL
3/16", 1/4", 5/16", 3/8", 1/2", 5/8"

Catalog No.	6+	3+	Each
20M04-201	-	-	32.95



PROVIDES
EASY, ACCURATE
BENDS IN COPPER,
STEEL & STAINLESS
UP TO 180°

TUBING BENDER
BENDS 3/8" DIAMETER TUBING

Catalog No.	6+	3+	Each
20R09-300	-	-	94.95



Denver 800-525-2484



WARNING
CANCER AND REPRODUCTIVE HARM-
WWW.P65WARNINGS.CA.GOV

Prices subject to change without notice

IRWIN. VISE-GRIP Pinch-off Tool

- Instantly pinches off rubber hose, tubing, copper
- Shut down only the part of the system that needs repair
- Stays locked and leaves hands free



20R09-120

10+ \$18.50 5+ 18.95 Ea. 19.95

Professional Grade O-Ring Tool Kit

MADE OF SOLID BRASS

Four distinctly different ends to aid in the installation and extraction of O-rings.



20S04-100

10+ \$9.95 5+ 10.95 Ea. 11.95



6 in 1 Screwdriver

Tough, industrial strength bits and heavy duty handle

USE AS:

- 1/4" or 5/16" nutdriver
- 2 size Phillips
- 2 size flathead



Catalog No.	Description	24+	12+	6+	Each
20E06-103	6 in 1 Screwdriver	4.76	5.14	5.50	5.95
20E06-104	Replacement Bit Set	3.32	3.53	3.70	4.03

5" Mini Pocket Screwdrivers

Available in Phillips or Flathead

BUY A SET OF BOTH AND SAVE!

WITH POCKET CLIP AND MAGNETIC TIP

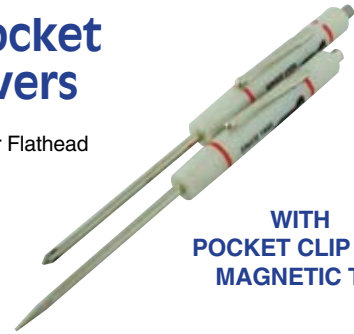

Catalog No.	Description	12+	6+	Each
20S08-101	Phillips Mini Screwdriver	1.95	2.10	2.25
20S08-102	Flathead Mini Screwdriver	1.95	2.10	2.25
20S08-103	Set Mini Screwdriver	3.50	3.75	3.95

Industrial Cobalt Drill Bit Set

DEWALT 14 pc

FOR STAINLESS & HEAVY STEEL

4X LONGER LIFE WHEN DRILLING STAINLESS STEEL VS. BLACK OXIDE BITS FOR METAL

INCLUDES:

- 2 x 1/16", 5/64", 3/32", 7/64", 2 x 1/8", 9/64", 5/32", 3/16", 7/32", 1/4", 5/16", 3/8"



20P11-116 3+ \$29.95 Ea. \$30.95

Eddy Products Heat Gun

PROFESSIONAL GRADE • RUGGED PERFORMANCE

MARK IV

- Temp range 500-750° F
- 3 position switch (off-cold-hot)
- 27 CFM air volume at 3300 FPM velocity
- Long-life heat element
- 115V, 12 amp, 1440 watt
- Includes hands-free stand
- Weighs under 3 lbs.



20T08-121 3+ \$74.95 Ea. \$78.95

Professional Grade Hole-Saws and Arbors

DESIGNED FOR MULTI APPLICATIONS INCLUDING STAINLESS STEEL

FEATURES RIP GUARD™, THE STRONGEST TOOTH FORM IN THE INDUSTRY

Milwaukee
HOLE DOZER™



Catalog No.	Description	3+	Each
20P11-101	Hole Saw, 7/8" diameter	12.95	13.95
20P11-100	Hole Saw, 1" diameter	11.95	12.95
20P11-108	Arbor for above items	9.95	10.95
20P11-109	Arbor for below items	20.95	21.95
20P11-102	Hole Saw, 1-1/2" diameter	13.95	14.95
20P11-103	Hole Saw, 2-1/8" diameter	19.95	20.95
20P11-104	Hole Saw, 3-1/8" diameter	23.95	24.95
20P11-105	Hole Saw, 4-1/8" diameter	27.95	28.95



Flambeau® Storage Systems

EXTREMELY DURABLE – BUILT TO LAST AND LAST AND LAST...

MOLDED FROM RUGGED COPOLYMER RESINS • DENT AND RUST PROOF • ODOR AND OIL RESISTANT

Storage Systems and Glass Washers

WITH SEE-THROUGH LIDS



1-SIDED CASE

13 COMPARTMENTS
Non-adjustable
11" L x 6-1/2" W x 1-3/4" H

14Q05-104
\$8.95



1-SIDED CASE

9-24 COMPARTMENTS
Adjustable
15" L x 11" W x 2-1/2" H

14Q05-105
\$21.95



2-SIDED CASE

18-48 COMPARTMENTS
Adjustable
15" L x 11" W x 5" H

14Q05-110
\$41.95

PLUS TOOL STORAGE



CANTILEVER TRAYS

36 COMPARTMENTS
Non-adjustable
18-1/2" L x 10-3/4" W x 10-3/8" H

14Q05-113
\$66.95

Additional price breaks available on most items. Login to your website account or contact your sales representative for pricing.

Metal Parts Box

9 ADJUSTABLE DIVIDERS



13-1/2" L x 9-1/2" W x 2" H
06G08-153 \$17.95

Metal Slide Rack

HOLDS 4 METAL PARTS BOXES



15-1/4" L x 11-3/4" W x 11-1/4" H
06G08-158 \$100.95

Metal Storage Cabinet

30 DRAWERS • STAND OR HANG



12" L x 6" W x 11-1/2" H
14Q05-112 \$39.95

Glass Washers & Replacement Brushes



- Toughest machine in the industry
- 8' power cord
- No special pumping required
- 10 year limited warranty



Ref. #	Catalog No.	Description	4+	2+	Each
1	14P09-120	5 Brush Glasswasher	399.95	414.95	430.95
2	14P09-121	6" Brush	13.50	13.95	14.95
3	14P09-125	6-3/4" Brush	13.95	14.95	15.95
4	14P09-126	7-1/2" Brush	14.95	15.95	16.95
5	14P09-122	8-1/2" Brush	19.95	20.95	21.95
6	14P09-123	Coffee Decanter Brush	23.95	25.95	26.95
7	20P09-101	LoSuds Soap, 1 gal.	24.95	-	25.95
8	20D08-201	Foxx LoFoam Soap, 1 gal.	9.95	-	10.95

3 Brush Manual Glass Washer

6-3/4" TALL BRUSHES

- Nylon bristles never collapse
- Compact and handy
- Positive suction base holds in place
- Sanitary and easy to maintain



Catalog No.	6+	3+	Each
14P09-117	33.95	35.95	37.95



Re-Circulating Line Cleaning Pump

MEDIUM DUTY DESIGNED FOR SHORT RUNS

Self priming duplex diaphragm pump may be run dry indefinitely without damage to pump. Internal re-circulating by-pass protects system from excess pressure. Siphons premixed cleaners from pail and re-circulates them.

- .5 amp
- 115V/60 Hz
- 14 1/2" L x 7" W x 6 3/4" H
- Weighs 16 lbs.

19M03-100
\$509.95



Re-Circulating Line Cleaning Pump

HEAVY DUTY DESIGNED FOR LONG RUNS

Direct drive, positive displacement pump gives constant flow through longer lines. Internal by-pass allows volume control by operator. It has a pulsation action, adding a "scrubbing" motion which aids in cleaning. It syphons premixed cleaner from pail and recirculates it.

- 1/3 HP motor
- Stainless steel Procon pump
- 5.3 amp
- 115V/60 Hz
- 12" L x 8" W x 7" H
- Weighs 30 lbs.

300' RUN & OVER

19M03-101
\$759.95



ABOVE LISTED MODEL WITH GAUGE – 19M03-102 **\$834.95**

Power Sanitizer Line Cleaning Pump

MEDIUM DUTY DESIGNED FOR SHORT RUNS

Outstanding value! This re-circulating pump is about half the price of competitive models. Lightweight and compact with a well constructed, heavy-duty carbonator motor, this unit is designed for direct draw and short run systems. It syphons premixed cleaner from the pail and recirculates it.

THIS UNIT CAN BE CUSTOMIZED

- 1/3 HP motor
- 6.3 amp
- 115V/60 Hz
- 11" L x 8" W x 7" H
- Weighs 21 lbs.

UNDER 100' RUN

09D03-156
\$325.95

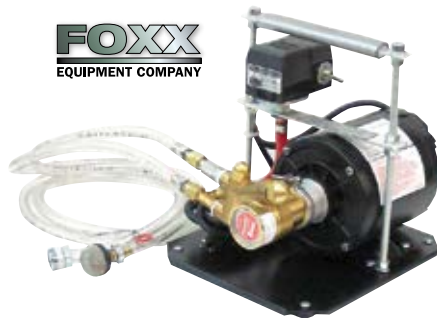

Re-Circulating Line Cleaning Pump

MEDIUM DUTY DESIGNED FOR SHORT RUNS

Self priming diaphragm pump may be run dry without damage to pump. Siphons premixed cleaners from pail and re-circulates them.

.70 amp • 115V/60Hz • 3/8" FPT inlet/outlet

09D03-157 Re-circulating Line Cleaning Pump **\$180.95**
09C07-117 Replacement pump only **\$155.95**



Additional price breaks available on most items. Login to your website account or contact your sales representative for pricing.

Sanke Cleaning Accessories



Ref. #	Catalog No.	Description	6+	3+	Each	Ref. #	Catalog No.	Description	6+	3+	Each
1	20D03-100	Faucet-to-Faucet Jumper (1')	8.95	9.50	9.95	7	20B03-139	Faucet Thread to 5/16" B Adapter	3.95	4.50	4.95
2	20C08-104	Series Flusher (Plastic)	4.27	4.54	4.80	8	20C08-108	Series Flusher w/Lifter (S/S)	22.95	23.95	24.95
3	20G09-103	Single/Series Flusher w/Lifter	35.95	36.95	38.95	9	20K09-110	Dual Flusher w/Lifters (Krome)	33.95	36.95	39.95
4	20G09-100	Single/Series Flusher	6.65	6.95	8.95	9	20S07-110	Dual Flusher w/Lifters (Taprite)	71.95	75.95	78.95
5	04B03-136	Cap & Washer (S/S)	2.50	2.95	3.95	10	20C08-105	6-way Manifold "Beer Thread" (S/S)	22.95	24.95	25.95
6	20G09-101	Dual Flusher w/Lifters	37.77	39.37	41.10	11	20C08-106	8-way Manifold "Beer Thread" (S/S)	30.95	32.95	34.95

Stainless Steel or Plastic Cleaning Cans

ORDER CLEANING CAN AND VALVES SEPARATELY AND FOXX WILL INSTALL BEFORE SHIPPING

REPLACEMENT PARTS STOCKED—CONTACT YOUR SALES REPRESENTATIVE FOR PRICING



20U07-100
\$100.95
1-HEAD
5 LITER



20C08-111
\$195.95
4-HEAD
11 LITER



20C08-117
\$198.95
4-HEAD
15 LITER



20C07-102
\$135.95
1-HEAD
18 LITER



20C07-103
\$185.95
4-HEAD
18 LITER

Stainless Steel Cleaning Can Valves

ORDER CLEANING CAN AND VALVES SEPARATELY AND FOXX WILL INSTALL BEFORE SHIPPING



20C08-110
42.95
"M" SYSTEM
Schneider
Einbecker



20C08-114
30.95
"G" SYSTEM
Boddington
Anchor Steam



20C08-116
42.95
"U" SYSTEM
Guinness
Harp



20C08-115
30.95
"A" SYSTEM
Paulaner
Warsteiner



20C08-113
30.95
"S" SYSTEM
Beck's
Newcastle



20C08-112
30.95
"D" SYSTEM
Anheuser-Busch
Coors / Miller

Additional price breaks available on most items. Login to your website account or contact your sales representative for pricing.



Heavy-Duty Clean-In-Place Adapters

SIMPLIFIES LINE CLEANING • EASY TO INSTALL • HIGHLY DURABLE



Choose the desired adapters and simply install in any walk-in cooler. Once in place, you will be able to quickly and easily clean any line as desired (multiple lines may be cleaned at the same time). Disconnect the coupler from the keg(s) and attach to the appropriate adapters(s), engage cleaning pump and fill lines with solution and clean lines. Flush lines with clean water until cleaning agent is gone and reattach the coupler(s) to the keg(s).

\$40.95 Ea.

CONNECT IN A SERIES AS MANY ADAPTERS AS DESIRED

CONNECT TO ANY LINE CLEANING PUMP, POWER SANITIZER OR CLEANING CAN



INLETS / OUTLETS REQUIRE 3/8" MPT FITTINGS

20T07-100
"M" SYSTEM
Schneider
Einbecker

20T07-101
"G" SYSTEM
Boddington
Anchor Steam

20T07-102
"U" SYSTEM
Guinness
Harp

20T07-103
"A" SYSTEM
Paulaner
Warsteiner

20T07-104
"S" SYSTEM
Beck's
Newcastle

20T07-105
"D" SYSTEM
Anheuser-Busch
Coors / Miller



Denver 800-525-2484



WARNING
CANCER AND REPRODUCTIVE HARM
WWW.P65WARNINGS.CA.GOV

Prices subject to change without notice

Cleaning Cans and Clean-in-Place Adapters

Keg Washing/Filling Head

DESIGNED FOR
WASHING & FILLING
SANKE KEGS



07D03-100

6+ **\$89.95**

3+ \$95.95 Ea. \$99.95

Test Coupler – American Sanke

USED TO TEST KEG PRESSURE AND BEER TEMPERATURE



Ref.	Catalog No.	Description	25+	10+	Each
1	18D03-122	Flex Faucet 4' length (Hex nut)	4.50	4.75	4.95
1	18D03-120	Flex Faucet 4' length (wing nut)	4.75	5.25	5.50
2	04B03-136	Cap & Washer (Stainless Steel)	2.50	2.95	3.95
Ref.	Catalog No.	Description	4+	2+	Each
3	20G09-104	Test Coupler	145.95	151.95	157.95

Beer Carbonation Tester



PROVIDES THE
CARBONATION
LEVELS IN BEER

USE WHEN
SETTING UP A NEW SYSTEM
OR TROUBLE SHOOTING
AN EXISTING SYSTEM

- High impact plastic canister
- Heavy duty metal cap
- Chrome plated brass quick disconnects/shutoff valves
- Rubber gauge boot protector
- 4.5 oz. capacity canister



20E09-120

\$283.95

COMPLETE WITH
HOSE FITTINGS AND
CARRY CASE

Additional price breaks available on most items. Login to your website account or contact your sales representative for pricing.

Sanke Keg Tap Pressure Tester

20D03-103

6+ **\$29.95** 3+ \$32.95 Ea. \$35.95



WITH
LIQUID-FILLED
GAUGE

Assorted Beer Wrenches

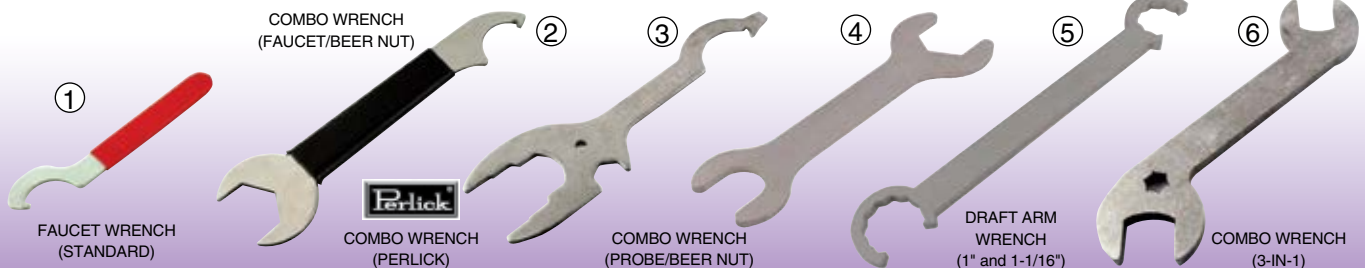

Ref. #	Catalog No.	Description	25+	10+	Each
1	20B03-125	Faucet Wrench (Standard)	2.59	2.76	2.89
2	20E07-100	Combo (Faucet/Beer Nut)	13.50	14.50	14.95
Ref. #	Catalog No.	Description	6+	3+	Each
3	12G09-160	Combo Wrench (Perlick)	18.50	18.95	19.95

Ref. #	Catalog No.	Description	6+	3+	Each
4	20K09-119	Combo (Probe/Beer Nut)	5.75	6.10	6.50
5	20N07-100	Draft Arm Wrench	24.95	25.95	26.95
6	20A03-129	Combo Wrench (3-in-1)	24.95	25.95	26.95

Testing Equipment and Wrenches

FIVE STAR



PRODUCTS FOR MASTER BREWERS, HOME BREWERS & GENERAL LINE CLEANING

P.B.W. Powdered Brewery Wash **Non-caustic alkaline cleaner used for equipment and line cleaning**

Removes proteins, soils, baked-on carbon and fatty acids • Safe to handle—non-hazardous, noncorrosive

Effective at all temperatures • Free rinsing • Excellent hard water resistance



Catalog No.	Size	3+	2+	Each	
20G06-149	120 gram/25 bottles	66.95	68.95	71.95	
Catalog No.	Size	48+	24+	12+	Each
20G06-110	1 lb.	6.50	6.75	7.25	7.75
Catalog No.	Size	24+	12+	6+	Each
20G06-111	4 lbs.	18.95	19.95	20.95	21.95
Catalog No.	Size	12+	8+	4+	Each
20G06-112	8 lbs.	35.95	37.95	39.95	42.95
Catalog No.	Size	8+	4+	2+	Each
20G06-113	50 lb. Pail	148.95	153.95	161.95	170.95
Catalog No.	Size	3+	2+	Each	
20G06-132	450 lb. Drum	1128.95	1162.95	1198.95	

L.L.C. Liquid Line Cleaner – Concentrated alkaline cleaner for line cleaning



NOTE
1 gallon containers are sold in multiples of four only and require a HAZARDOUS FEE by UPS/FEDEX

- Removes proteins, soils, reduces beer stone and odor
- Fast soil penetration, emulsifies fats
- Low foaming formula
- Effective at all temperatures
- Excellent hard water resistance

Catalog No.	Size	24+	12+	6+	Each
20G06-106	32 oz.	9.50	9.95	10.50	10.95
Catalog No.	Size		12+	8+	4+
20G06-107	1 gal.	–	19.95	20.95	21.95

Acid Cleaner #6 Formulated to clean aluminum kegs and can also be used for line cleaning



NOTE
1 gallon containers are sold in multiples of four only and require a HAZARDOUS FEE by UPS/FEDEX

NOTE 5 gallon containers ship via truck line only – cannot ship UPS/FEDEX

Catalog No.	Size	24+	12+	8+	4+
20G06-130	1 gallon	18.95	19.95	20.95	22.95
Catalog No.	Size		8+	4+	Each
20G06-131	5 gallon	–	92.95	95.95	99.95

Acid Cleaner #5 Formulated to passivate and re-passivate stainless steel



NOTE
1 gallon containers are sold in multiples of four only and require a HAZARDOUS FEE by UPS/FEDEX

NOTE 5 gallon containers ship via truck line only – cannot ship UPS/FEDEX

Catalog No.	Size	24+	12+	8+	4+
20G06-115	1 gallon	12.50	12.95	13.50	14.50
Catalog No.	Size	8+	4+	2+	Each
20G06-116	5 gallon	58.95	60.95	62.95	63.95

Five Star Chemicals



FIVE STAR



PRODUCTS FOR MASTER BREWERS, HOME BREWERS & GENERAL LINE CLEANING

Star San Acid Sanitizer

A synergistic acid blend provides a unique killing system that is unaffected by excessive organic soils

- Kills a broad spectrum of bactericide and fungicide
- No rinse requirement when used at 300 ppm
- Accepted by USDA as a general sanitizer



NOTE 1 gallon sold in multiples of four only and requires a HAZARDOUS fee by UPS/FEDEX. 5 gallon containers ship via truck line only—cannot ship UPS/FEDEX.

Catalog No.	Size	100+	50+	25+	Each
20G06-126	4 oz.	4.25	4.50	4.75	4.95
Catalog No.	Size	48+	24+	12+	Each
20G06-127	8 oz.	6.95	7.50	7.95	8.50
20G06-128	16 oz.	10.95	11.50	11.95	12.50
Catalog No.	Size	40+	20+	10+	Each
20G06-129	32 oz.	15.50	15.98	17.01	17.95
Catalog No.	Size	24+	12+	8+	4+
20G06-138	1 gallon	36.95	38.95	40.95	42.95
Catalog No.	Size	4+	2+	Each	
20G06-529	5 gallon	—	176.95	181.95	186.95

Star-Xene Final Rinse Sanitizer

5% aqueous stabilized chlorine dioxide

- Excellent in C.I.P. applications
- Broad spectrum killer
- When acidified, becomes a very active sanitizer



Catalog No.	Size	4+	2+	Each
20G06-222	2-1/2 gal.	144.95	147.95	151.95
20G06-522	5 gal.	276.95	283.95	290.95

i0-Star Iodophor Sanitizer

For sanitizing beverage containers, walls and equipment

- Effective against ecoli, s typhose, mold and yeast
- Reduces odors
- Low foaming and easy to use
- Self-indicating



Catalog No.	Size	100+	50+	25+	Each
20G06-123	4 oz.	2.20	2.30	2.40	2.50
Catalog No.	Size	20+	10+	5+	Each
20G06-124	32 oz.	11.50	11.95	12.95	13.50
Catalog No.	Size	8+	4+	2+	Each
20G06-125	1 gal.	33.95	35.95	37.95	39.95

Sani-Clean Final Acid Rinse

A low foam, final acid anionic rinse for fermenters and parts soaking

- Leaves tanks and equipment spotless
- Not affected by organic materials
- No rinse requirement when used at 200ppm
- Accepted by USDA



NOTE 5 gallon containers are considered HAZARDOUS and ship via truck line only—cannot ship UPS/FEDEX

Catalog No.	Size	40+	20+	10+	Each
20G06-105	32 oz.	11.95	12.95	13.95	14.95
Catalog No.	Size	4+	2+	Each	
20G06-505	5 Gallons	—	145.95	149.95	153.95

5² pH Stabilizer

Optimizes the enzymatic activity of your malt and helps clarify wort

- Helps control the pH of your brewing water
- More consistent hop usage in the boil
- Reduce scaling and mineral deposition in the lauter



Catalog No.	Size	24+	12+	6+	Each
20G06-118	4 oz.	4.95	5.50	5.95	6.50
Catalog No.	Size	24+	12+	6+	Each
20G06-119	1 lb.	9.50	9.95	10.50	10.95
Catalog No.	Size	4+	2+	Each	
20G06-120	7 lbs.	—	59.95	62.95	65.95
20G06-141	40 lbs.	—	—	294.95	302.95

Super Moss Pro

Designed to attract the positively charged, haze forming proteins

- Helps reduce chill haze
- Formulated to mix rapidly in cold water
- Carries through the primary fermentation
- Safe to handle



Catalog No.	Size	12+	6+	3+	Each
20G06-133	1 lb.	15.95	16.95	17.95	18.95
20G06-134	3-1/2 lb.	—	49.95	52.95	56.95
20G06-135	7 lb.	—	100.95	105.95	112.95

Five Star Chemicals

Line Cleaning Chemicals



BLC Line Cleaner
AN ALKALINE COMPOUND
 Nitrate free formula
 Low in phosphates
 Use 2 oz. per gallon of water

BLC is a highly effective cleaner and one of our milder brands. BLC is ideal for direct draw systems, tap boxes, or any system that uses shorter runs. AVAILABLE IN 4 oz. -- see below

20G05-102 32 oz. Bottle	48+	24+	12+	Each
	7.59	8.01	8.50	9.01



CLEAR-TAP Line Cleaner
AN ALKALINE COMPOUND
 Nitrate free formula
 Low in phosphates
 Use 1.5 oz. per gallon of water

CLEAR-TAP is a highly effective cleaner and one of our mid-strength brands. Clear-Tap is ideal for long draw systems. CONTAINS A RINSE INDICATOR DYE.

20G05-118 32 oz. Bottle	48+	24+	12+	Each
	8.30	8.77	9.28	9.86



PENETRATE Line Cleaner
AN ALKALINE COMPOUND
 Nitrate free formula
 Low in phosphates
 Use 1 oz. per gallon of water

PENETRATE is a highly effective cleaner and one of our strongest brands. Penetrate is ideal for very long draw, cooled and neglected or older systems. WORKS WELL IN LOW TEMPERATURES.

20G05-110 32 oz. Bottle	48+	24+	12+	Each
	8.41	8.87	9.40	9.98



DAC Line Cleaner
AN ALKALINE COMPOUND
 Nitrate free formula
 Low in phosphates
 Use 1 oz. per gallon of water

DAC is a highly effective cleaner made with dual alkalines and our most powerful brand. DAC is ideal for very long draw, cooled and neglected systems. TWIN ALKALINE FORMULA.

20G05-109 32 oz. Bottle	48+	24+	12+	Each
	9.31	9.85	10.47	10.99



ALC Line Cleaner
AN ACID COMPOUND
 Nitrate free formula
 Low in phosphates
 Use 1 oz. per gallon of water

Use ALC as part of a regular cleaning rotation on lines with specialty brews, Imports and beers using high calcium, brewing water. IT IS IMPORTANT TO DO AN ALKALINE CLEANING FIRST.

20G05-112 32 oz. Bottle	48+	24+	12+	Each
	8.00	8.50	8.95	9.50



WINE Line Cleaner
AN ALKALINE COMPOUND
 Nitrate free formula
 Low in phosphates
 Use 1 oz. per gallon of water

WLC removes wine molds, yeast, tannins, residues and tartrate deposits. This keeps the bouquet, clarity, color and taste true to the vision of the vintner and pleasing to the palate.

20G05-111 32 oz. Bottle	48+	24+	12+	Each
	8.30	8.77	9.28	9.86



BLC Line Cleaner
AN ALKALINE COMPOUND

BLC is a highly effective cleaner and one of our milder brands. BLC is ideal for direct draw systems, tap boxes, or any system that uses shorter runs. AVAILABLE IN 32 oz. -- see above

20G05-119 4 oz. Bottle	100+	50+	25+	Each
	2.02	2.13	2.26	2.40



SUPER-NO-RINSE
POWDERED LINE CLEANER

Ideal for short beverage systems and brewing equipment. Contains 100% active cleaning and water conditioning agents with no inert fillers. CONTAINS A RINSE INDICATOR DYE.

20G05-100 5 lb. Tub	16+	8+	4+	Each
	20.95	22.95	23.95	24.95



ALL KLEAR Dye Tabs
RINSE INDICATOR DYE

Add to any alkaline or acid product to produce a blue product color. Certified food safe. USE 1 TAB FOR UP TO 5 GALLONS OF WATER

Catalog No.	Description	4+	2+	Each
20G05-126	50 tablets	6.50	6.95	7.25
20G05-127	200 tablets	13.95	14.95	15.50



Craft Meister Growler Tablets

Fast-acting tablet easily cleans growlers – no brushes or agitation needed! Add tablet and fill growler with warm water and watch as soils break down in just minutes.

Catalog No.	Size	12+	6+	Each
20G05-142	25 tablets	3.87	4.13	4.38
Catalog No.	Size	6+	3+	Each
20G05-143	150 tablets	14.76	15.58	16.50



Craft Meister Alkaline Brewery Wash

Quickly breaks down the toughest soils but will not burn your skin or damage stainless steel, plastic, or glass. Reduces calcium carbonate and oxalate residues that oxygen cleaners leave behind. Works in all water conditions. Removes labels from bottles in minutes! Not for use on aluminum.

Catalog No.	Size	4+	2+	Each
20G05-134	40 lbs.	109.95	112.95	117.95

Cleans brew kettles, corny kegs, fermentors, fittings, tubings and bottles. Quick dissolving powder • Rinses clean • No chalky build-up



Craft Meister Oxygen Brewery Wash

Don't waste time soaking and scrubbing! Fast-acting oxygen tears up soils in just minutes with little agitation needed. Formulated to combat calcium carbonate. Rinses clean with no residue left behind. Easily removes bottle labels. Powder dissolves quickly and works in all water conditions.

Catalog No.	Size	24+	12+	6+	Each
20G05-135	1 lb.	5.71	6.11	6.50	6.95
Catalog No.	Size	8+	4+	2+	Each
20G05-137	5 lbs.	21.95	22.95	23.95	25.95
Catalog No.	Size	4+	2+	Each	
20G05-138	40 lbs.	-	127.95	124.95	127.95

Cleans brew kettles, corny kegs, fermentors, fittings, tubings and bottles. Quick dissolving powder • Rinses clean • No chalky build-up



Food Grade Lubricants

NSF Dow Corning Silicone Lubricant
FOR LUBRICATING O-RINGS, GASKETS, FITTINGS

- Heavy consistency
- Lubricates o-rings, gaskets, seals, rubber and more
- FDA approved



20A01-112
5.3 oz. Tube

12+	6+	Each
18.95	19.95	20.95

NSF Petro-Gel Sanitary Lubricant
FOR LUBRICATING O-RINGS, GASKETS, FITTINGS

- Odorless and tasteless
- Heavy consistency
- Lubricates o-rings and more
- FDA approved



20G09-215
4.0 oz. Tube

12+	6+	Each
2.95	3.25	3.50

NSF Purity Sanitary Lubricant
FOR LUBRICATING O-RINGS, GASKETS, FITTINGS

- Odorless and tasteless
- Contains no silicone
- Non-toxic liquid petrolatum
- FDA approved



20D08-116
16 oz. Spray

12+	6+	Each
7.50	7.95	8.50

DBC Mineral and Lime Solvent
MULTI PURPOSE CLEANER

- Eliminates mineral deposits and lime build up
- Effectively removes grease, smoke residue, algae, yeast and mildew from most surfaces
- Use on stainless steel, chrome, aluminum, glass, enamel, vinyl and tile surfaces



20G05-140
32 oz. Bottle

48+	24+	12+	Each
9.12	9.63	10.20	10.84

Slide Out Dry Silicone Spray
FOOD GRADE LUBRICANT

- Lubricates o-rings, gaskets, seals and more
- Leaves a non-staining dry pure silicone film to lubricate moving parts
- Will not gum up, freeze, or become rancid
- Approved for use in food processing areas



20D08-115
11.5 oz. Spray

24+	12+	6+	Each
5.50	5.95	6.50	6.95

Sanitizers and Coffee Machine Cleaners

Farm & Food Sanitizer

HIGHLY CONCENTRATED

- Quick and thorough product line sanitizer
- Sanitizes food surfaces
- Colorless and odorless
- 1 oz. per gallon of water



20R01-101
1 Gallon

4+	2+	Each
13.95	14.95	15.95

TDC Detergent First Tank

FOR HAND WASHING GLASSES

- Cuts grease and oils
- Contains water softeners
- Safe on plastic, metal, stainless steel



20G05-104
32 oz. Bottle

48+	24+	12+	Each
8.61	9.09	9.63	10.23

LFD Detergent First Tank

FOR AUTOMATIC DISHWASHERS

- Cuts grease and oils
- Contains water softeners
- Safe on plastic, metal, stainless steel



20G05-107
32 oz. Bottle

48+	24+	12+	Each
7.59	8.01	8.50	9.01

Iodophor Sanitizer Last Tank

COMMERCIAL STRENGTH

- Odorless and tasteless
- Kills bacteria
- Reduces spotting
- Commercial strength for bars, restaurants, etc.



20G05-103
32 oz. Bottle

48+	24+	12+	Each
13.83	14.46	15.37	16.27

Iodophor Sanitizer Last Tank

COMMERCIAL STRENGTH

- Odorless and tasteless
- Kills bacteria
- Reduces spotting
- Commercial strength for bars, restaurants, etc.



20G05-117
16 oz. Bottle

48+	24+	12+	Each
8.61	9.09	9.63	10.23

BTF Sanitizer Last Tank

COMMERCIAL STRENGTH

- Odorless and tasteless
- Kills bacteria
- Reduces spotting
- Commercial strength for bars, restaurants, etc.



20G05-106
16.75 oz. Tub

48+	24+	12+	Each
13.53	14.28	15.13	16.07

BTF Chlor-Tab Cleaner/Sanitizer

FOR ALL TYPES OF GLASSWARE

- Convenient pre-measured tablets
- Economical –1 tablet per bar sink
- Leaves no residue, odor or taste
- Includes water conditioning chemicals
- EPA registered and FDA approved



20G05-139
100 Tablet Jar

48+	24+	12+	Each
16.95	17.95	18.95	19.95

Coffee Pot Liquid Cleaner

FOR PLASTIC, GLASS AND STAINLESS STEEL

- Not recommended for use with aluminum
- For stubborn stains use product with a brush



20G05-121
16 oz. Bottle

12+	6+	Each
4.55	4.81	5.11



100% AMERICAN

OWNED AND MANUFACTURED

MEET THE STRONGEST LINE CLEANER IN THE USA

DRAFTEC'S proprietary additive package was designed to attack every element of beer stone when beer breaks down in your draft lines. DRAFTEC will eliminate mineral crystals, hops resins, proteins, carbohydrates and biofilms that are embedded in the polymers of the beer tubing.



BEER LINE CLEANER

32 oz. BOTTLES

In The Choice Of

CLEAR

or

BLUE TRACELINE INDICATOR

PALLET SHIPMENTS FREE FREIGHT – 4 DRUMS MIXED



HAZMAT FEES WILL APPLY – DROP SHIP ONLY

BEER LINE CLEANER

Catalog No.	Description	4+	2+	Each
20A11-105	Beer Line Cleaner, 55 gallon (Clear)	569.95	585.95	599.95
20A11-107	Beer Line Cleaner, 55 gallon (Blue)	569.95	585.95	599.95

ACID LINE CLEANER

Catalog No.	With Tracer Dye Added	4+	2+	Each
20A11-106	Acid Line Cleaner, 55 gallon (Clear)	569.95	585.95	599.95
20A11-108	Acid Line Cleaner, 55 gallon (Red)	569.95	585.95	599.95



Draftec® and Purdy Products Chemicals

Catalog No.	Description	48+	24+	12+	Each
20A11-101	Beer Line Cleaner, 32 oz. (Clear)	6.25	6.50	6.95	7.50
20A11-103	Beer Line Cleaner, 32 oz. (Blue)	6.25	6.50	6.95	7.50

\$5.25 EA. AND FREE FREIGHT
ON PALLET SHIPMENTS OF 52 CASES – MIXED PRODUCT



ACID LINE CLEANER

32 oz. BOTTLES

In The Choice Of

CLEAR

or

RED TRACELINE INDICATOR

Catalog No.	Description	48+	24+	12+	Each
20A11-102	Acid Line Cleaner, 32 oz. (Clear)	6.25	6.50	6.95	7.50
20A11-104	Acid Line Cleaner, 32 oz. (Red)	6.25	6.50	6.95	7.50



Sanitizers and Cleaners for the Beverage Industry

ALL PRODUCTS ARE HIGHLY EFFECTIVE, COST/SHIPPING EFFICIENT AND COME IN EASY-TO-USE-SINGLE USE PACKAGING.



GENERAL PURPOSE
Cleans, sanitizes and removes mineral deposits all in one procedure. Exceeds local / federal health agency standards.



TEA EQUIPMENT
Specifically designed to completely clean and sanitize all equipment used in the tea industry. NSF listed and FDA approved as a sanitizer.



COFFEE EQUIPMENT
An all-purpose commercial brewing equipment cleaner. Designed to remove oils, tough residues and mineral deposits.

Perfect for use on product tanks/kegs or any hard surface. NSF Listed.

Perfect for use on all brewing equipment or any hard surface. NSF Listed.

Perfect for use on all brewing, dispensing equipment or any hard surface.

20P05-200 4 lb. Jar			
12+	8+	4+	Each
15.50	15.95	16.50	16.95

20P05-110 1.5 oz. (80 pkt/case)			
8+	4+	2+	Each
29.95	31.95	33.95	35.95

20P05-120 .75 oz. (150 pkt/case)			
8+	4+	2+	Each
15.95	16.95	17.95	18.95



Denver 800-525-2484



WARNING
CANCER AND REPRODUCTIVE HARM.
WWW.P65WARNINGS.CA.GOV

Prices subject to change without notice

TM DESANA[®] MAX

2in1 – THE WORLD'S BEST BEER LINE CLEANER WITH COLOR VERIFIER



HIGH CONTAMINATION



NORMAL CONTAMINATION



THOROUGHLY CLEAN



TM DESANA[®] MAX starts out PURPLE. Once in the lines, it will turn either **YELLOW** or **GREEN** depending on the level of contamination. Clean as recommended and flush lines with clean water. Reinsert a small amount of fresh mix. If product remains **PURPLE**, your product lines are thoroughly **CLEAN**.

5

FIVE YEAR SHELF LIFE
Super-dry mono-dose packets can be stored in cold or warm for up to five years.



SAFE & EXACT DOSING
Each packet will make 1.2 gallons of solution. No incorrect dosing. Powder dissolves very quickly.



REDUCE SHIPPING COST
Eleven times less weight of its equivalent in liquids. Each case makes 270 gallons of solution.

TESTED & APPROVED
Some of the most renowned independent institutes and companies have tested and approved TM DESANA[®] MAX



20T02-100 1.9 oz. each
prices are per packets

CASE 450 PACKETS \$1.45 Ea.

CASE 225 PACKETS \$1.55 Ea.

100+ \$1.65 50+ \$1.75 Ea. \$1.95

TM Desana[®] Max and Foxx Brand



SUPERFLUSH and HIGH ALKALINE

HIGH QUALITY BEER LINE CLEANERS

EQUALS MAJOR BRANDS AT A FRACTION OF THE COST

Superflush

A mild blend of detergents for normal line cleaning

- Concentrated formula with a mix ratio of 2 to 3 oz. per gallon of water
- Biodegradable formula
- Safe for use on all lines
- Great for parts cleaning
- Economically priced



High Alkaline

A high alkaline/low foam formula for professionals only

- Concentrated formula with a mix ratio of 1.2 to 1 oz. per gallon of water
- Rinses through quickly
- Safe for use on all lines
- Great for parts cleaning
- Economically priced



Catalog No.	Description	48+	24+	12+	Each
20G09-209	Superflush 32 oz.	2.95	3.25	3.50	3.95

Catalog No.	Description	48+	24+	12+	Each
20L09-101	High Alkaline 32 oz.	4.95	5.50	5.95	6.50

VANTAGE ENZYME Line Cleaner

THE 1ST NON-TOXIC, NON-CAUSTIC LINE CLEANER FOR DRAFT SYSTEMS

SAFE • EFFECTIVE • AFFORDABLE



32 oz. bottle

REQUIRED: **VANTAGE ENZYME**

Hazard Symbol	NONE ✓
Signal Words	NONE ✓
Hazard Statement	NONE ✓
Precautionary Statements	NONE ✓

ENZYME LINE CLEANER

- Safe enough to drink
- As effective as caustics
- Comparable cost-wise

ENZYME				
Catalog No.	48+	24+	12+	Each
20G05-147	23.95	25.95	26.95	27.95

ALKALINE BOOST

Used in conjunction with Vantage Enzyme Cleaner to help neglected systems

ALKALINE BOOST				
Catalog No.	48+	24+	12+	Each
20G05-148	6.46	6.72	7.17	7.67

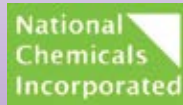

Vantage Enzyme, Flavor Rescue & BevClean

VANTAGE Flavor Rescue Kit

KNOCK OUT OFF-FLAVORS IN ONLY ONE APPLICATION!

4-PIECE KIT IS PRE-MEASURED TO RESCUE ONE TRUNKLINE



FLAVOR RESCUE KIT			
Catalog No.	4+	2+	Each
20G05-149	100.95	104.95	109.95

BE THE HERO!

Vantage Flavor Rescue Kit removes unwanted flavors (LIKE HARD ROOT BEER) at a fraction of the cost to replace the damaged line or the entire trunkline



USAGE:
ONE TIME USE
UP TO 115' MAX.

BevClean B-I-B Cartridge Beverage System Cleaner



NEUTRALIZES
PUNGENT
FLAVORS

20B05-150
3-GALLON

*1 PALLET / 72 pc **\$12.95***

3+ \$15.95 Ea. \$16.95

NO-RINSE • FOOD-SAFE • TASTELESS • ODORLESS

- Cleans from the rack to the dispensing point
- Lab tested & proven safe for all system components
- No buckets, no mixing, no waiting, no rinsing
- Neutralizes pungent flavors in most cases
- Quickly perform flavor changes without replacing tubing
- Use regularly to reduce quality issues

*SHIPS DIRECT FROM MANUFACTURER



Electrical Contact Cleaner

- Safe for use on electric motors, electronic parts, refrigeration equipment, glycol chillers, etc.
- Safe on most surfaces (test on plastic BEFORE using)
- Quick dry, non-flammable and non-conductive
- Leaves no residue and displaces moisture
- 16 oz.

Catalog No.	12+	6+	Each
20D08-112	6.95	7.50	7.95



Foaming Citrus Cleaner/Degreaser

- Especially formulated to remove built-up grease and soils unaffected by other cleaners
- Combines emulsifiers, surfactants, and a citrus cleaner for superior cleaning and a great shine
- Works great on most hard surfaces
- 18 oz.

GREAT FOR VENDING MACHINES

Catalog No.	12+	6+	Each
20L09-104	4.25	4.50	4.95



Stainless Steel Cleaner/Polisher

- Cleans, polishes, shines and protects with ease
- Also works on: chrome, aluminum, porcelain, tile, formica, vinyl, and most plastic surfaces
- Resists fingerprints, water spots, and soiling
- Minimum effort required to remove soil and dirt
- Approved for use in food processing exterior areas
- 14.5 oz.

Catalog No.	12+	6+	Each
20D08-105	6.95	7.50	7.95



Heavy Duty Foaming Degreaser

- High density clinging foam sticks to all surfaces
- Tough on grease, dirt, oil, smoke film and more
- Great on metal, glass, tile, grout, some plastics
- Combines emulsifiers, surfactants and butyl cleaner for superior cleaning action on most surfaces
- Contains no fragrances or dyes
- 18 oz.

Catalog No.	12+	6+	Each
20D08-101	4.25	4.50	4.95



VS 102 Industrial Insecticide

KILLS ROACHES, ANTS, SILVERFISH & MORE
PLEASANT VANILLA FRAGRANCE

- Approved for use in food areas
- EPA registered / NSF rated
- Kills common insects quickly
- 15 oz.

Catalog No.	12+	6+	Each
20D08-114	6.95	7.50	7.95



Concession / Equipment Cleaner

CLEANS CONCESSION, FOOD & COFFEE EQUIPMENT
Removes: protein residues, cooking oils, syrups, grease, coffee bean oils, starches, sugars

- Thick foam clings to vertical surfaces
- Safe for use on most hard surfaces
- 18 oz.

Catalog No.	12+	6+	Each
20D08-117	4.70	4.95	5.95



100% Silicone Sealant (Food Grade)

- Tough, durable and flexible
- Can be applied to virtually any surface
- 3 oz. tube

Catalog No.	24+	12+	6+	Each
20A08-103	4.60	4.80	5.10	5.40



Professional Scouring Pads



MEDIUM DUTY
6" x 9" PAD

Catalog No.	20+	10+	Each
20G07-096	0.69	0.74	0.77



PTFE Thread Seal Tape

For sealing NPT threads

- Provides a leak-free, air-tight seal
- Prevents seizing or cross-threading
- For use on air, water and other fittings
- Can be used on brass, copper, stainless

Catalog No.	Description	Each
20D01-200	PTFE Tape	3.72
20D01-201	Liquid Thread Sealant (4 oz.)	6.78
20D01-202	Application Brush	0.15



1/2"W x 1429"L



Iridescent Leak Detector

LOCATES LEAKS QUICKLY

- Thick liquid clings to area applied
- Creates bubbles when leak is present
- Iridescence helps pinpoint the leak
- For use with compressed gas lines

Catalog No.	24+	12+	Each
19R06-118	6.50	6.95	7.50

8 fl. oz.
24/Case



Peek Non-Abrasive Cleaner/Polisher

CLEANS Even badly tarnished and oxidized items are brought back to life

PROTECTS Leaves behind a light, lasting and protective coating on the surface

POLISHES When finished, surfaces are left bright, shiny and beautiful

20T01-102
39.3 oz. Can Paste

Ea. **\$32.95**



Spray Cleaners and Miscellaneous



Premium Black Nitrile Disposable Gloves

POWDER-FREE • LATEX-FREE • TOUGHER THAN OTHER BRANDS



NEW
NAME AND
PACKAGING—
SAME GLOVE
was **GlovePlus**

- Excellent chemical resistance
 - Micro-roughened on the palm and lightly textured fingertips provide good grip
- 20G06-144 MEDIUM** (100/GLOVES PER BOX)
20G06-145 LARGE (100/GLOVES PER BOX)
20G06-146 X-LARGE (100/GLOVES PER BOX)

10+ **\$8.95** 5+ \$9.95 Ea. \$10.95



Premium Heavy-Duty Orange Nitrile Gloves

POWDER-FREE • LATEX-FREE • DIAMOND TEXTURED FOR IMPROVED GRIP



- Excellent chemical resistance
- Dexterity of a 7 mil glove / durability of a 10 mil
- Resists tearing better than other disposables

20G06-150 LARGE (100/GLOVES PER BOX)
20G06-151 X-LARGE (100/GLOVES PER BOX)

10+ **\$13.50** 5+ \$13.95 Ea. \$14.95

Chemical Test Papers

USED FOR MEASURING THE CONCENTRATION OF A SPECIFIC CHEMICAL IN A SOLUTION



IODINE TEST PAPERS

100 PER VILE



CHLORINE TEST PAPERS

100 PER VILE



pH TEST PAPERS

50 PER PKG

Catalog No.	Description	10+	5+	Each
20G05-124	Iodine Test Papers 100/vile	4.42	4.81	5.07
20G05-125	Chlorine Test Papers 100/vile	4.42	4.81	5.07
20G05-130	pH Test Papers 50/pkg.	9.50	10.06	10.95

Gloves, Brushes and Chemical Testing

Faucet and Line Cleaning Brushes

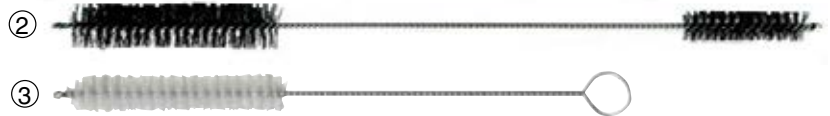
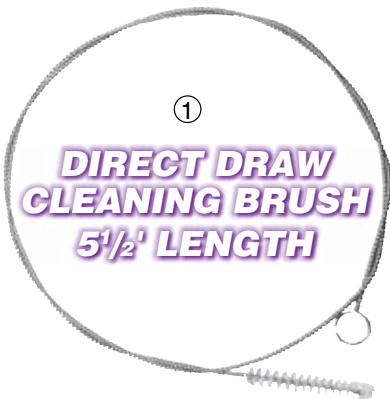

Ref. #	Catalog No.	Description	25+	10+	Each
1	20N01-110	5-1/2' length x 3/16" dia.	2.60	2.76	2.90
1	20N01-111	5-1/2' length x 1/4" dia.	2.50	2.66	2.79
1	20N01-113	5-1/2' length x 3/8" dia.	3.30	3.51	3.68
1	20N01-112	5-1/2' length x 1/2" dia.	3.30	3.51	3.68
2	20L01-102	Double end 1/2" & 3/4" dia	2.25	2.35	2.50
3	20L01-103	Single end 3/4" dia. Heavy Duty	1.25	1.30	1.50

"Checker" The Pocket pH Tester



- Readings from 0-14pH with a resolution of 0.01 pH
- Fast, accurate and lightweight
- 3,000 hour battery life
- Easy to read LCD display

20G05-141
 3+ **\$42.95**
 Ea. \$44.95



pH Calibration Kit

Liquid Sachets pH 4.01 & 7.01

(5 PACKETS EACH)



20G05-242
\$21.95



304 Stainless Steel "NSF" Towers

304 GRADE S/S SHANKS AND FAUCETS • BEV-SEAL ULTRA® WITH GLAS-FLEX™ LINER TUBING
POLISHED STAINLESS STEEL EXTERIOR • 3" DIAMETER • KNOBS SOLD SEPARATELY

**FLUSHABLE
TASTE BARRIER**



11B03-352

3+ **\$107.95** Ea. \$111.95



11B03-354

3+ **\$169.95** Ea. \$176.95



11B03-389

3+ **\$269.95** Ea. \$280.95

304 Stainless Steel "Milano" Towers

304 GRADE S/S SHANKS, LINES AND FAUCETS • CHROME PLATED BRASS BODY • 15" HEIGHT
INCLUDES 6" THREADED BRASS MOUNTING SLEEVE AND NUT • KNOBS SOLD SEPARATELY

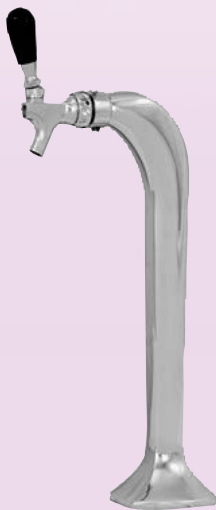

11U07-218

Ea. **\$268.95**



11U07-219

Ea. **\$309.95**



11U07-220

Ea. **\$364.95**

Wine and Coffee Dispensing Products

304 Stainless Steel "Deluxe" Towers

304 GRADE S/S SHANKS AND FAUCETS • BEV-SEAL ULTRA™ WITH GLAS-FLEX LINER TUBING
POLISHED STAINLESS STEEL EXTERIOR • 3" DIAMETER • KNOBS SOLD SEPARATELY



11B07-200

3+ **\$97.95** Ea. \$104.95



11B07-203

3+ **\$153.95** Ea. \$163.95



11B07-205

3+ **\$218.95** Ea. \$233.95

304 Stainless Steel "NSF" Tee-Towers

304 GRADE S/S SHANKS AND FAUCETS • BEV-SEAL ULTRA™ WITH GLAS-FLEX LINER TUBING
BRUSHED STAINLESS STEEL EXTERIOR • 3" DIAMETER • KNOBS SOLD SEPARATELY



FLUSHABLE TASTE BAR



FRONT TO BACK IS 5"
FAUCET CLEARANCE IS 10-1/2"



Catalog No.	No. of Faucets	Faucets on Center	Overall Height	Overall Width	Each
11B03-367	3	3"	15"	12"	388.95
11B03-368	4	3"	15"	12"	443.95
11B03-369	5	3"	15"	15"	525.95
11B03-370	6	3"	15"	19"	634.95
11B03-371	8	2-3/8"	15"	19"	780.95

Wine and Coffee Dispensing Products



304 Grade Stainless Steel Faucets



Krome dispense

NSF

12K02-104

24+ \$18.50

12+ \$18.95 Ea. \$19.95



304 S/S

WINE CERTIFIED COFFEE

12K02-113

24+ \$21.95

12+ \$22.95 Ea. \$24.95



Perlick

NSF

12G09-290

24+ \$39.95

12+ \$42.95 Ea. \$45.95



12G09-291

24+ \$45.95

12+ \$48.95 Ea. \$52.95

Edge-Tap Faucets



Krome dispense

304 S/S

316 S/S

WINE CERTIFIED COFFEE

12K02-112

24+ \$19.95

12+ \$20.95 Ea. \$22.95

12K02-111

12+ \$26.50

6+ \$26.95 Ea. \$27.95

304 S/S Stout Faucets

12U07-120
12+ \$66.95
6+ \$29.95 Ea. \$32.95

WINE CERTIFIED COFFEE

304 S/S

INCLUDES FREE KNOB WHILE SUPPLIES LAST!

12K07-120

12+ \$42.95

6+ \$29.95 Ea. \$32.95

304 Stainless Steel Shanks

MORE 304 S/S SHANKS AVAILABLE ON PAGE 177

Krome dispense

304 S/S

WINE CERTIFIED COFFEE

1/4" BORE					
Catalog No.	Length	Max. Wall Thickness	24+	12+	Each
12K07-102	2"	3/8"	4.50	4.75	4.95
12K07-103	3-1/8"	1-1/2"	9.95	10.50	10.95
12K07-104	4-1/8"	2-1/2"	9.25	9.50	9.95
12K07-105	5-1/8"	3-1/2"	8.95	9.50	9.95
12K07-106	6-1/8"	4-1/2"	11.50	11.95	12.50
12K07-108	8-1/8"	6-1/2"	16.95	17.50	17.95



304 Stainless Steel Column Shanks

304 Stainless Steel Tower Shanks

MORE 304 STAINLESS STEEL COLUMN SHANKS AVAILABLE — SEE PAGE 159



3/16"

12K03-201
6+ **\$10.95**
3+ 11.50
Ea. \$11.95



1/4"

12K03-205
6+ **\$12.95**
3+ 13.50
Ea. \$13.95



1/4"

12B03-318
12+ **\$26.95**
6+ \$27.95
Ea. \$28.95



3/16"

12A03-218
12+ **\$29.95**
6+ \$31.95
Ea. \$33.95



304 Stainless Steel "Beer Thread" Shutoff



04B07-101
50+ **\$16.95**
25+ \$17.95
10+ \$18.95
Ea. \$19.95



05K03-157
50+ **\$10.95**
25+ \$11.95
10+ \$12.95
Ea. \$13.95



SWIVEL NUT

Additional price breaks available on most items. Login to your website account or contact your sales representative for pricing.

In-line Flow Control/Shutoffs



1/4" BARBS

05C07-130
100+ **\$4.95** 50+ \$5.25
25+ \$5.50 10+ \$5.75 Ea. \$5.95



3/8" BARBS

05C07-131
100+ **\$4.95** 50+ \$5.25
25+ \$5.50 10+ \$5.75 Ea. \$5.95

304 Stainless Steel Fittings - MORE ON PAGES 91-97 AND PAGES 198-200

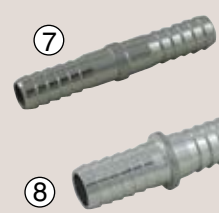
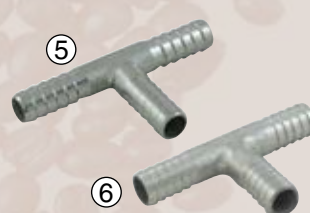
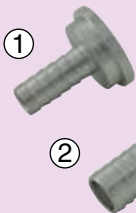

Ref. #	Catalog No.	Description	100+	50+	25+	Each
1	04C03-101	Tailpiece, S/S 1/4" Barb	1.80	1.90	2.00	2.10
2	04C03-102	Tailpiece, S/S 3/8" Barb	1.80	1.90	2.00	2.10
3	05C03-104	90° Tailpiece, S/S 1/4" Barb	2.95	3.25	3.45	3.75
4	04C03-304	Hex Nut, S/S Beer Thread	2.50	2.95	3.25	3.50

Ref. #	Catalog No.	Description	100+	50+	25+	Each
5	04C11-134	Tee, S/S 1/4" Barbs - All	0.75	0.80	0.85	0.90
6	04C11-213	Tee, S/S 3/8" Barbs - All	1.10	1.20	1.30	1.40
7	04C11-139	Splicer, S/S 1/4" Barb	0.55	0.60	0.65	0.70
8	04C11-282	Splicer, S/S 3/8" Barb	0.80	0.90	0.95	1.05



Nitrogen Regulators



ECONOMY - NITROGEN REGULATORS				
Catalog No.	Description	24+	12+	6+ Each
UNAVAILABLE UNTIL FURTHER NOTICE				

CORNELIUS - NITROGEN REGULATORS				
Catalog No.	Description	24+	12+	6+ Each
03D03-168	60:3000 lb Gauges and 1/4" MFL Check	39.95	41.95	42.95 44.95
03D03-266	100:3000 lb Gauges and 1/4" MFL Check	41.95	43.95	44.95 46.95
03D03-169	60:3000 lb Gauges and 5/16" Barb Shutoff w/Check	43.95	44.95	46.95 48.95
03D03-267	100:3000 lb Gauges and 5/16" Barb Shutoff w/Check	45.95	46.95	48.95 50.95

TAPRITE- NITROGEN REGULATORS				
03D03-114	60:3000 lb Gauges and 1/4" MFL Check	43.95	44.95	46.95 48.95
03C09-119	100:3000 lb Gauges and 1/4" MFL Check	42.95	43.95	45.95 47.95
03C09-115	60:3000 lb Gauges and 5/16" Barb Shutoff w/Check	46.95	47.95	50.95 51.95
03C09-114	100:3000 lb Gauges and 5/16" Barb Shutoff w/Check	46.95	47.95	49.95 51.95

NORGREN - NITROGEN REGULATORS				
03D03-166	60:3000 lb Gauges and 1/4" MFL Check	73.95	75.95	78.95 81.95
03G07-266	100:3000 lb Gauges and 1/4" MFL Check	73.95	75.95	78.95 82.95
03D03-167	60:3000 lb Gauges and 5/16" Barb Shutoff w/Check	76.95	78.95	81.95 85.95
03G07-267	100:3000 lb Gauges and 5/16" Barb Shutoff w/Check	76.95	78.95	82.95 86.95

304 Stainless Steel Probe Sanke Keg Couplers

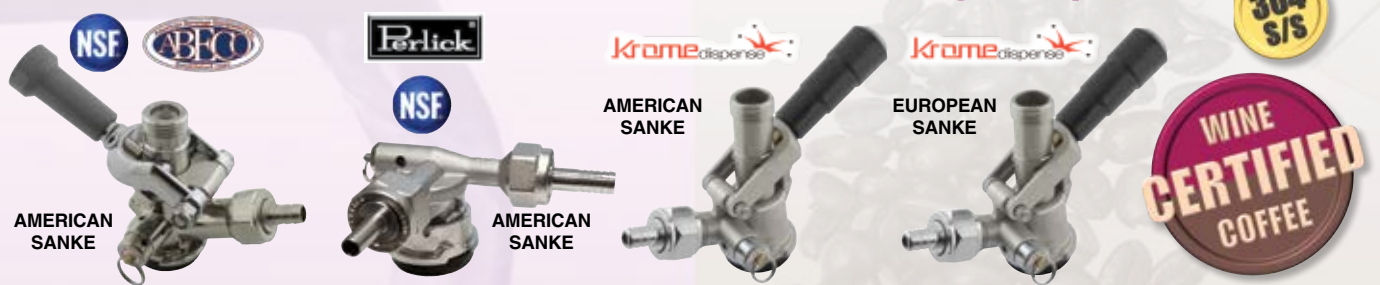

Catalog No.	Description	24+	12+	Each
07S07-100	ABECO-American Sanke (304 S/S)	36.95	38.95	41.95
07G09-207	PERLICK-American Sanke (304 S/S)	62.95	67.95	73.95

Catalog No.	Description	24+	12+	Each
07K07-106	KROME-American Sanke (304 S/S)	26.50	26.95	28.95
07K07-107	KROME-European Sanke (304 S/S)	26.50	26.95	28.95

304 Stainless Steel Motorless Carbonating/Nitrogenating Tank

QUICKLY CARBONATE OR NITROGENATE ANY BEVERAGE IN MINUTES

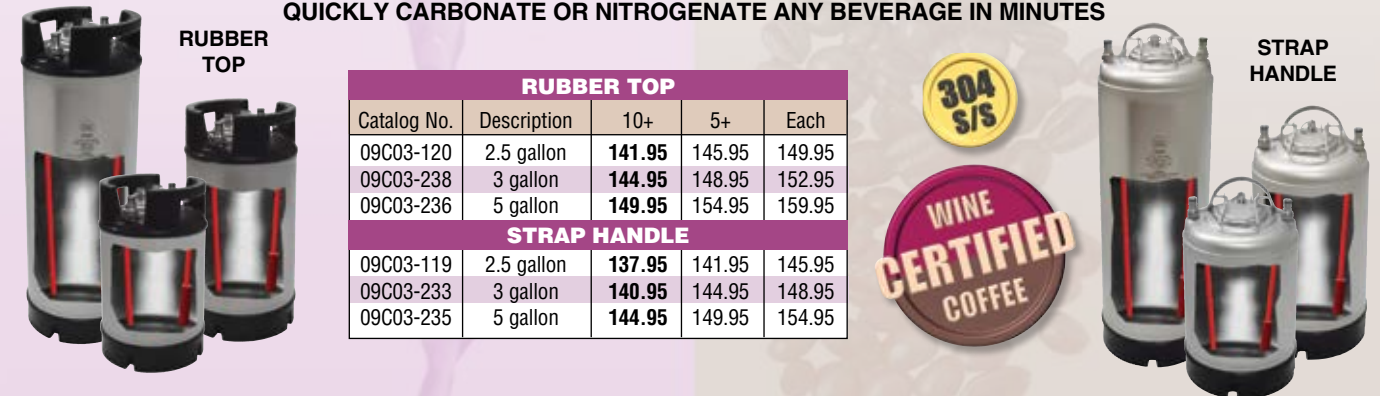

RUBBER TOP				
Catalog No.	Description	10+	5+	Each
09C03-120	2.5 gallon	141.95	145.95	149.95
09C03-238	3 gallon	144.95	148.95	152.95
09C03-236	5 gallon	149.95	154.95	159.95
STRAP HANDLE				
09C03-119	2.5 gallon	137.95	141.95	145.95
09C03-233	3 gallon	140.95	144.95	148.95
09C03-235	5 gallon	144.95	149.95	154.95

Bev-Seal Ultra® Series 235 – POLYOLEFIN TUBE WITH INTERNAL DUAL BARRIER

Prevents flavor permeation • Works well with pungent flavors • Lightweight and very flexible
 Allows quick flavor changeovers without taste transfer • NSF approved for use with wine and other high % alcohol content beverages

PERFECT FOR WINE AND CIDER						PRICES PER 100'				PRICE PER FOOT
Catalog No.	I.D.	O.D.	Working Pressure at 70° F	Clamp Index	Roll Size	4 Rolls	2 Rolls	1 Roll	100' Section	Under 100'
08H05-249	1/4"	3/8"	125	B	500'	16.71	17.90	18.98	21.60	.40
08H05-248	5/16"	7/16"	100	C	500'	19.95	21.37	22.67	25.79	.50
08H05-250	3/8"	1/2"	100	F	500'	23.09	24.74	26.24	29.86	.60
08H05-251	1/2"	5/8"	75	H	500'	31.75	34.01	36.08	41.05	.70





QUICK CHILL™ PRODUCTS

Visit our website for full listing of Quick Chill Products at www.foxxequipment.com

TEE TOWERS

Includes a restriction kit to balance each faucet in the field.



Overall Height	12-15/16"
Faucet Clearance	9"
Faucet Centers (2)	5-1/2"
Faucet Centers (3-8)	2-3/4"
Faucet Centers (9-12)	3"
Base Width (2-7)	4-5/8"
Base Width (8)	7-5/8"
Base Width (9-12)	12"

Faucets & knobs sold separately
See page 179-182 for Perlick® faucets

SEVEN TOWERS

Illuminated medallion models available upon request.

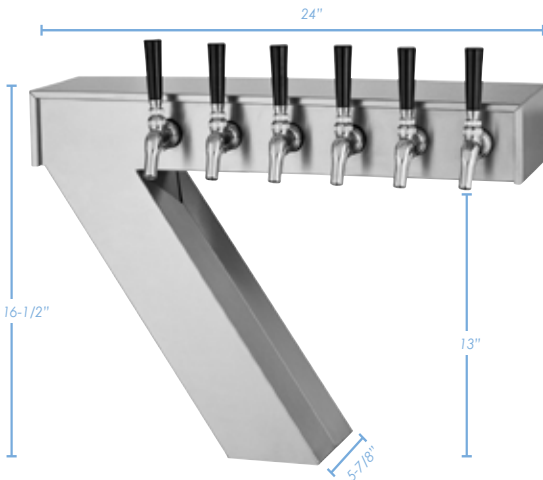

Tee Towers - Glycol Cooled

Stainless Steel, Polished Chrome or PVD Gold

Part No.	Faucets	Width	Body	Price
11G09-270	2	9-1/8"	Stainless Steel	419.00
11G09-271	2	9-1/8"	Chrome	445.00
11G09-272	2	9-1/8"	Gold	513.00
11G09-273	3	9-1/8"	Stainless Steel	453.00
11G09-274	3	9-1/8"	Chrome	479.00
11G09-275	3	9-1/8"	Gold	554.00
11G09-276	4	11-7/8"	Stainless Steel	497.00
11G09-277	4	11-7/8"	Chrome	526.00
11G09-278	4	11-7/8"	Gold	581.00
11G09-279	5	14-5/8"	Stainless Steel	621.00
11G09-280	5	14-5/8"	Chrome	676.00
11G09-281	5	14-5/8"	Gold	726.00
11G09-282	6	17-3/8"	Stainless Steel	694.00
11G09-283	6	17-3/8"	Chrome	734.00
11G09-284	6	17-3/8"	Gold	814.00
11G09-285	7	20-1/8"	Stainless Steel	731.00
11G09-286	7	20-1/8"	Chrome	820.00
11G09-287	7	20-1/8"	Gold	903.00
11G09-288	8	22-7/8"	Stainless Steel	814.00
11G09-289	8	22-7/8"	Chrome	912.00
11G09-290	8	22-7/8"	Gold	989.00
11G09-291	9	26-7/8"	Stainless Steel	894.00
11G09-292	9	26-7/8"	Chrome	970.00
11G09-293	9	26-7/8"	Gold	1113.00
11G09-294	10	29-13/16"	Stainless Steel	1009.00
11G09-295	10	29-13/16"	Chrome	1095.00
11G09-296	10	29-13/16"	Gold	1254.00
11G09-297	12	35-3/4"	Stainless Steel	1118.00
11G09-298	12	35-3/4"	Chrome	1215.00
11G09-299	12	35-3/4"	Gold	1395.00

Seven Towers - Glycol Cooled

Stainless Steel, Polished Chrome, or PVD Gold

Part No.	Faucets	Centers	Body	Price
11G09-230	4	5"	Chrome	948.00
11G09-231	4	5"	Gold	1079.00
11G09-232	4	5"	Stainless Steel	921.00
11G09-233	5	3-3/4"	Chrome	1082.00
11G09-234	5	3-3/4"	Gold	1254.00
11G09-235	5	3-3/4"	Stainless Steel	1071.00
11G09-236	6	3"	Chrome	1187.00
11G09-237	6	3"	Gold	1377.00
11G09-238	6	3"	Stainless Steel	1123.00

Perlick Quick Chill Towers and Drains





QUICK CHILL™ PRODUCTS

Visit our website for full listing of Quick Chill Products at www.foxxequipment.com

BRIDGE TEE TOWERS

Features all-metal stainless steel, polished chrome or tarnish free brass bodies.

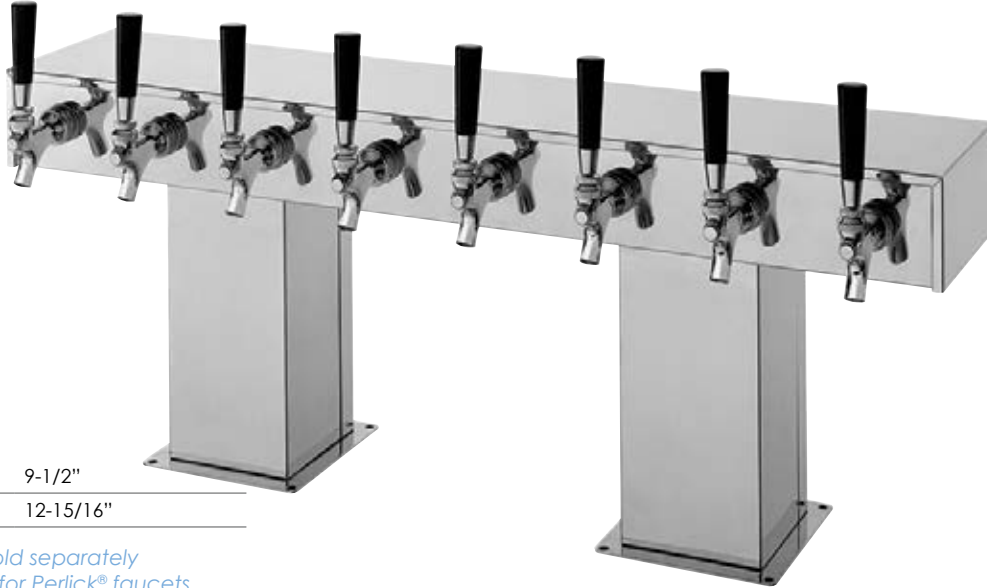

Faucet Height	9-1/2"
Overall Height	12-15/16"

Faucets & knobs sold separately
See page 179-182 for Perlick® faucets

Bridge Tee Towers

Stainless Steel, Polished Chrome, or PVD Gold

Part No.	Faucets	Body	Faucet Centers	Width	Center-Center Base	Price
11G09-300	8	Stainless Steel	4-1/8"	33-1/8"	16-1/2"	989.00
11G09-301	8	Chrome	4-1/8"	33-1/8"	16-1/2"	1067.00
11G09-302	8	Gold	4-1/8"	33-1/8"	16-1/2"	1186.00
11G09-303	10	Stainless Steel	3"	33-1/8"	16-1/2"	1323.00
11G09-304	10	Chrome	3"	33-1/8"	16-1/2"	1457.00
11G09-305	10	Gold	3"	33-1/8"	16-1/2"	1544.00
11G09-306	12	Stainless Steel	2-3/4"	33-1/8"	16-1/2"	1412.00
11G09-307	12	Chrome	2-3/4"	33-1/8"	16-1/2"	1500.00
11G09-308	12	Gold	2-3/4"	33-1/8"	16-1/2"	1652.00
11G09-309	16	Stainless Steel	2-3/4"	44-1/8"	22"	1995.00
11G09-310	16	Chrome	2-3/4"	44-1/8"	22"	2101.00
11G09-311	16	Gold	2-3/4"	44-1/8"	22"	2331.00
11G09-312	20	Stainless Steel	2-3/4"	55-1/8"	27-1/2"	2051.00
11G09-313	20	Chrome	2-3/4"	55-1/8"	27-1/2"	2162.00
11G09-314	20	Gold	2-3/4"	55-1/8"	27-1/2"	2407.00
11G09-315*	24	Stainless Steel	3"	71-11/16"	23-7/8"	2027.00
11G09-316*	24	Chrome	3"	71-11/16"	23-7/8"	2206.00
11G09-317*	24	Gold	3"	71-11/16"	23-7/8"	2539.00
11G09-318*	30	Stainless Steel	3"	89-9/16"	29-13/16"	2413.00
11G09-319*	30	Chrome	3"	89-9/16"	29-13/16"	2621.00
11G09-320*	30	Gold	3"	89-9/16"	29-13/16"	3020.00

*Towers have 3 Bases instead of 2



QUICK CHILL™ PRODUCTS

Visit our website for full listing of Quick Chill Products at www.foxxequipment.com

Perlick Quick Chill Towers and Drains



WINGED TEE TOWERS

Illuminated medallion models available upon request.

Overall Height	16-1/2"
Faucet Clearance	13"
Faucet Centers	3"
Base Width	4-1/16"
Base Depth	5-9/16"

Faucets & knobs sold separately

Winged Tee Towers - Glycol Cooled

Polished Stainless Steel or PVD Gold

Part No.	Faucets	Width	Body	Price
11G09-250	4	12-3/4"	Stainless Steel	765.00
11G09-251	4	12-3/4"	Gold	937.00
11G09-252	5	15-3/4"	Stainless Steel	840.00
11G09-253	5	15-3/4"	Gold	1033.00
11G09-254	6	18-3/4"	Stainless Steel	912.00
11G09-255	6	18-3/4"	Gold	1123.00
11G09-256	8	24-3/8"	Stainless Steel	1088.00
11G09-257	8	24-3/8"	Gold	1345.00

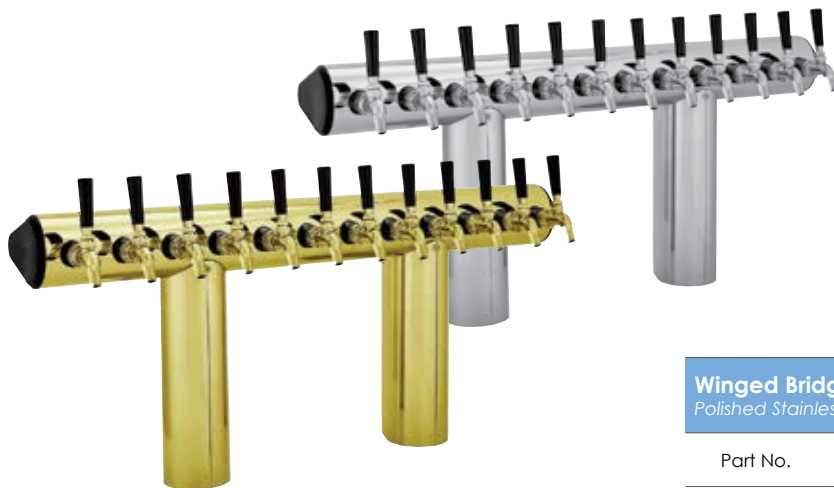

WINGED BRIDGE TOWERS

Illuminated medallion models available upon request.

Overall Height	16-1/2"
Faucet Clearance	13"
Base Width	4-1/16"
Base Depth	5-9/16"
Center to Center	16-1/2"

Faucets & knobs sold separately

Winged Bridge Towers - Glycol Cooled

Polished Stainless Steel or PVD Gold

Part No.	Faucets	Centers	Width	Body	Price
11G09-260	8	4-1/8"	32-5/8"	Stainless Steel	1230.00
11G09-261	8	4-1/8"	32-5/8"	Gold	1516.00
11G09-262	10	3"	30-3/4"	Stainless Steel	1374.00
11G09-263	10	3"	30-3/4"	Gold	1698.00
11G09-264	12	3"	36-3/4"	Stainless Steel	1536.00
11G09-265	12	3"	36-3/4"	Gold	1902.00



12G09-290

12G09-291

12G09-301

See pages 179-182 for Perlick's patented, award-winning, forward-sealing faucets.



QUICK CHILL™ PRODUCTS

Visit our website for full listing of Quick Chill Products at www.foxxequipment.com

BREW PIPE TOWERS

Features all metal stainless steel pipe for an industrial look in a pass-thru style. Beer Leads for 12-20 faucet models will be dispersed through both legs.

Overall Height	20"
Faucet Clearance	14"
Faucet Centers	3"
Base Diameter	9"
Pipe Diameter	4-1/2"

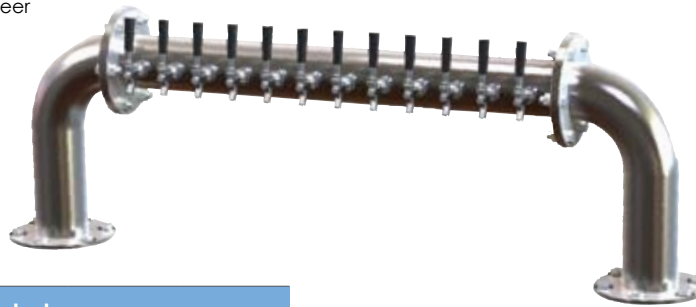

Faucets & knobs sold separately.

Brew Pipe Towers - Glycol Cooled Stainless Steel

Part No.	Faucets	Beer Leads	Width	Center to Center	Price
11G09-100	6	Left	37-5/8"	33-1/8"	4253.00
11G09-101	8	Left	43-5/8"	39-1/8"	4725.00
11G09-102	10	Left	49-5/8"	45-1/8"	5248.00
11G09-103	6	Right	37-5/8"	33-1/8"	4253.00
11G09-104	8	Right	43-5/8"	39-1/8"	4725.00
11G09-105	10	Right	49-5/8"	45-1/8"	5248.00

See pages 179-182 for Perlick's patented, award-winning, forward-sealing faucets.

Brew Pipe Towers - Glycol Cooled Stainless Steel

Part No.	Faucets	Beer Leads	Width	Center to Center	Price
11G09-106	12	Both	55-5/8"	51-1/8"	5913.00
11G09-107	16	Both	67-1/2"	63"	6385.00
11G09-108	20	Both	79-3/8"	74-7/8"	6907.00

EXTREME TOWER

Has Illuminated Medallion

Faucets & knobs sold separately.



Extreme Tower - Glycol Cooled Polished Chrome

Part No.	Faucets	Width	Price
11G09-110	1	3-15/16"	724.00

LOTUS TOWERS

Faucets & knobs sold separately.



Lotus Towers - Glycol Cooled Polished Chrome

Part No.	Faucets	Top Width	Base Width	Price
11G09-120	1	3-1/2"	3-1/8"	643.00
11G09-121	2	6-1/4"	3-3/8"	912.00
11G09-122	3	6-1/4"	3-3/8"	967.00
11G09-123	4	13-1/8"	4-1/4"	1512.00
11G09-124	5	13-1/4"	4-1/4"	1542.00

BRIGITTE TOWERS

Illuminated medallion models available upon request.

Faucets & knobs sold separately.



Brigitte Towers - Glycol Cooled Polished Chrome

Part No.	Faucets	Width	Price
11G09-130*	3	17-13/16"	934.00
11G09-131	5	22-1/4"	1164.00
11G09-132	7	31-1/2"	2349.00

See page 179-182 for Perlick® faucets

*Faucets on Center: 6-3/8"

Perlick Quick Chill Towers and Drains



QUICK CHILL™ PRODUCTS

Visit our website for full listing of Quick Chill Products at www.foxequipment.com



LUCKY TOWERS

304 Grade Stainless Steel Wine Towers available

Overall Height	16-1/6"
Body Width	3-7/8"
Faucet Clearance	12-15/16"
1-Faucet Width	3-7/8"
2-Faucet Width	4-3/8"
3-Faucet Width	7"

Faucets & knobs sold separately



PANTHER TOWERS

304 Grade Stainless Steel Wine Towers available

Overall Height	15-3/4"
Head Width	6-9/16"
Base Width	3-7/16"
Faucet Clearance	13-1/16"
3-Faucet Width	8-3/8"
4-Faucet Width	9-5/8"

Faucets & knobs sold separately

Lucky Towers - Glycol Cooled

Polished Chrome or PVD Gold

Part No.	Faucets	Body	Price
11G09-140	1	Chrome	483.00
11G09-141	1	Gold	483.00
11G09-142	2	Chrome	654.00
11G09-143	2	Gold	654.00
11G09-144	3	Chrome	718.00
11G09-145	3	Gold	718.00

Panther Towers - Glycol Cooled

Polished Chrome or PVD Gold

Part No.	Faucets	Body	Price
11G09-160	3	Chrome	882.00
11G09-161	3	Gold	882.00
11G09-162	4	Chrome	992.00
11G09-163	4	Gold	992.00

Lucky Towers - Air Cooled

Polished Chrome or PVD Gold

Part No.	Faucets	Body	Price
11G09-150	1	Chrome	539.00
11G09-151	1	Gold	541.00
11G09-152	2	Chrome	667.00
11G09-153	2	Gold	670.00

Panther Towers - Air Cooled

Polished Chrome or PVD Gold

Part No.	Faucets	Body	Price
11G09-170	3	Chrome	1016.00
11G09-171	3	Gold	1020.00
11G09-172	4	Chrome	1139.00
11G09-173	4	Gold	1144.00

Drip Pans for Lucky & Panther Towers

Stainless Steel or PVD Gold

Part No.	Overall Dimensions	Body	Price
11G09-180	16" L x 16" W	Stainless Steel	245.00
11G09-181	16" L x 16" W	Gold	298.00
11G09-182*	16" L x 23-1/4" W	Stainless Steel	305.00
11G09-183*	16" L x 23-1/4" W	Gold	363.00

*Not recommended for two, 4-Faucet Panther Towers

See pages 179-182 for Perlick® faucets.



Perlick Quick Chill Towers and Drains





QUICK CHILL™ PRODUCTS

Visit our website for full listing of Quick Chill Products at www.foxxequipment.com

CUTOUT DRIP PANS

- Includes:
 Removable Glass Rack
 1/2" O.D. Brass Drain Socket
 3/8" Barbed Elbow Hose Coupling



Cutout Drip Pans - For Torino Towers

PVD Gold

Part No.	Diameter	Depth	Dimensions	Price
11G09-199	10"	1"	19-3/4" L x 10" W	319.00

SERVICE STATION DROP IN DRAINERS

Service Station Drop in Drainers provide a flush, mounted, stainless steel, draining surface. Designed for installation into a cut-out opening in the bar.

- Includes:
 1/2" O.D. Brass Drain Tube



Service Station Drop in Drainers

Stainless Steel

Part No.	Overall Dimensions	Price
11G09-240	12" L x 24" W	187.00
11G09-241	12" L x 30" W	212.00
11G09-242	12" L x 36" W	235.00
11G09-243	12" L x 42" W	260.00
11G09-244	12" L x 48" W	285.00
11G09-245	18" L x 24" W	236.00
11G09-246	18" L x 30" W	272.00
11G09-247	18" L x 36" W	309.00
11G09-248	18" L x 42" W	346.00
11G09-249	18" L x 48" W	381.00

TORINO CERAMIC TOWERS

Features a full ceramic body with PVD Gold details and collar.



Blue



White



Overall Height	26-7/8"
Faucet Clearance	16-5/8"
TYP	5-5/8"
Base Diameter	9-7/8"

Faucets & knobs sold separately

Torino Ceramic Towers - Glycol Cooled

PVD Gold Detailing

Part No.	Faucets	Color	Price
11G09-193	2	Blue	1278.00
11G09-194	2	Green	1278.00
11G09-195	2	White	1278.00
11G09-196	3	Blue	1410.00
11G09-197	3	Green	1410.00
11G09-198	3	White	1410.00



12G09-290



12G09-291



12G09-301

See pages 179-182 for Perlick's patented, award-winning, forward-sealing faucets.

Perlick Quick Chill Towers and Drains



QUICK CHILL™ PRODUCTS

Visit our website for full listing of Quick Chill Products at www.foxequipment.com



Part No.	19G09-301
Price	1684.00

Customized tanks used in conjunction with an NSF circulation pump, timer and line connections provide a system the properly mixes and automatically controls the mixing to provide perfectly mixed drink. Towers, faucets, and kits sold separately.



DRAFT COCKTAIL DIRECT DRAW DISPENSER/CHILLER

For dispensing chilled pre-mixed cocktails.

Requires 304 Grade Stainless Steel Wine Tower

Cabinet Dimensions

	Length	Depth	Height
Exterior	36"	24.75"	34.565"
Interior	20"	18.75"	28.5"

Electrical Specifications

Electrical Supply	120 VAC/60 Hz/1 Ph/3.2 Amps Running
Defrost Initiation	Automatic
Defrost Type	Off Cycle
Thermostat	Digital Control

Refrigeration Specifications

Horsepower	1/5
Refrigerant	R134a
Refrigerator Temp Range	34-42°F
Condensing Unit Location	Left or Right
Front Vented	Yes

TOBIN ELLIS PRE-MIXED COCKTAIL DISPENSING KITS

For automatically mixing pre-mixed bulk cocktails.

5 Gallon Tobin Ellis Pre-Mixed Cocktail Dispensing Kits

Use with Cocktail Direct Draw Dispenser/Chiller

Part No.	Description	Price
15G09-100	5 Gallon - Requires Wine Towers	905.00

Kit Includes:

- 5 Gallon, Circulating Cocktail Keg
- Circulation Pump for Cocktail Keg
- Circulating Pump Connection Kit for Cocktail Keg
- Cocktail Keg Tower Connection Kit for Direct Draw

Individual components available for sale. Contact your sales representative for pricing.

10 Gallon Tobin Ellis Pre-Mixed Cocktail Dispensing Kits

Use with Cocktail Direct Draw Dispenser/Chiller

Part No.	Description	Price
15G09-101	10 Gallon - Requires Wine Towers	975.00

Kit Includes:

- 10 Gallon, Circulating Cocktail Keg
- Circulation Pump for Cocktail Keg
- Circulating Pump Connection Kit for Cocktail Keg
- Cocktail Keg Tower Connection Kit for Direct Draw

Individual components available for sale. Contact your sales representative for pricing.

Towers, faucets and knobs sold separately. See pages 179-182 for Perlick® faucets.

Perlick Quick Chill Cocktail Dispenser



QUICK CHILL™ PRODUCTS

Visit our website for full listing of Quick Chill Products at www.foxxequipment.com

PP SERIES POWER PAKS

Includes: 6' length power cord

GLYCOL SOLD SEPARATELY

Requires 1 gallon for the reservoir and 1 additional gallon per 85' of trunkline

GLYCOL MIXTURE: 30% Glycol to 70% Distilled Water

Thermostat	Rotary Type
Electrical	120V/60 Hz
Overall Length	28"
Overall Width	21-3/4"
Overall Height	16-3/4"



PP Series Power Paks - All Models

Galvanized with Bronze Finish

Part No.	Compressor	Max Run Length	Pumps	Circuit	BTU/h	Shipping Weight	Price
19G09-200	1/5 HP	50' (per Pak)	1	15 AMP	1600	105 lb	1335.00
19G09-201	1/3 HP	150' (per Pak)	1	20 AMP	2550	120 lb	1685.00
19G09-202	1/2 HP	250' (per Pak)	1	20 AMP	3800	125 lb	1885.00

4400 SERIES POWER PAKS

GLYCOL SOLD SEPARATELY

Requires 1 gallon for the reservoir and 1 additional gallon per 85' of trunkline

GLYCOL MIXTURE: 30% Glycol to 70% Distilled Water

Thermostat	Digital Type
Electrical	120V/60 Hz
Overall Length	24-1/4"
Overall Width	17-1/4"
Overall Height	25-1/2"



No power cord included – contact an electrician for installation

4400 Series Power Paks - 1/3 HP Model

Powder Coated Black

Part No.	Compressor	Max Run Length	Pumps	Circuit	BTU/h	Shipping Weight	Price
19G09-203	1/3 HP	125' (per Pak)	1	20 AMP	3420	140 lb	1916.00

Perlick Quick Chill Glycol Chillers



QUICK CHILL™ PRODUCTS

Visit our website for full listing of Quick Chill Products at www.foxxequipment.com



4400 SERIES POWER PAKS

GLYCOL SOLD SEPARATELY

Requires 2 gallon for the resevoir and 1 additional gallon per 85' of trunkline

GLYCOL MIXTURE: 30% Glycol to 70% Distilled Water

Thermostat	Digital Type
Electrical	120V/60 Hz
Overall Length	24-1/4"
Overall Width	17-1/4"
Overall Height	25-1/2"

No power cord included - contact an electrician for installation

4400 Series Power Paks - 1/2 HP Models

Powder Coated Black

Part No.	Compressor	Max Run Length	Pumps	Circuit	BTU/h	Shipping Weight	Price
19G09-212	1/2 HP	250' (per Pak)	1	20 AMP	4800	153 lb	2175.00
19G09-210	1/2 HP	250' (per Pak)	2	30 AMP	4800	163 lb	2579.00

Perlick Quick Chill Glycol Chillers



4400 SERIES POWER PAKS

GLYCOL SOLD SEPARATELY

Requires 2 gallon for the resevoir and 1 additional gallon per 85' of trunkline

GLYCOL MIXTURE: 30% Glycol to 70% Distilled Water

Thermostat	Digital Type
Electrical	120V/60 Hz
Overall Length	24-1/4"
Overall Width	17-1/4"
Overall Height	25-1/2"

No power cord included - contact an electrician for installation

4400 Series Power Paks - 3/4 HP Models

Powder Coated Black

Part No.	Compressor	Max Run Length	Pumps	Circuit	BTU/h	Shipping Weight	Price
19G09-204	3/4 HP	450' (per Pak)	1	30 AMP	6300	180 lb	2360.00
19G09-211	3/4 HP	450' (per Pak)	2	30 AMP	6300	190 lb	2850.00





QUICK CHILL™ PRODUCTS

Visit our website for full listing of Quick Chill Products at www.foxxequipment.com

4400 SERIES POWER PAKS

GLYCOL SOLD SEPARATELY

Requires 2 gallon for the resevoir and 1 additional gallon per 85' of trunkline

GLYCOL MIXTURE: 30% Glycol to 70% Distilled Water

Thermostat	Digital Type
Electrical	230V/60 Hz
Circuit	40 amp (dedicated)
BTU/h	12000
Overall Length	26-3/4"
Overall Width	20-1/4"
Overall Height	31"



No power cord included - contact an electrician for installation

4400 Series Power Paks - 1-1/2 HP Models

Powder Coated Black

Part No.	Compressor	Max Run Length	Pumps	Shipping Weight	Price
19G09-205	1-1/2 HP	825' (per Pak)	1	255 lb	3225.00
19G09-208	1-1/2 HP	825' (per Pak)	2	265 lb	3760.00
19G09-209	1-1/2 HP	825' (per Pak)	3	275 lb	4199.00

EQUIPMENT STANDS



Dimensions	36" L x 24" W x 26" H
Top Shelf	304 Stainless Steel
Top Capacity	800 lb
Bottom Capacity	620 lb
Black Splash	2" (Back and Sides)

Equipment Stands

Stainless Steel or Galvanized Steel

Part No.	Undershelf & Leg Material	Price
19G09-114	Stainless Steel	325.95
19G09-113	Galvanized Steel	210.95

WALL MOUNT BRACKETS

- Kit Includes:
- (6) 1/4" x 3" Lag Screws
 - (8) 1/4" Flat Washer
 - (2) 1/4" - 20x3/4" Screws
 - (2) Locking Clips
 - (2) 1/4" - 20 Stop Nuts
 - (1) Left Wall Bracket
 - (1) Right Wall Bracket
 - (1) Front Cross Interlock

Chiller sold separately.



**Additional price breaks available. Log into your online account or contact sales representative.*

Wall Mount Brackets

Part No.	Models	Price*
19G09-206	4400 Series (1/3 & 1/2 HP)	107.95
19G09-207	PP Series (ALL)	134.95

Perlick Quick Chill Glycol Chillers



QUICK CHILL™ PRODUCTS

Visit our website for full listing of Quick Chill Products at www.foxxequipment.com

PUMP/MOTOR KITS

Add to existing Power Paks to handle additional Trunkline(s).
For 4400 Series Power Paks



Pump/Motor Kits

Part No.	Electrical	Units	GPH	PSIG	Price
19G09-100	115V	1/2 HP	100 GPH	130 PSIG	392.00
19G09-102	115V	3/4 HP	100 GPH	130 PSIG	402.00
19G09-101	230V	1-1/2 HP	100 GPH	130 PSIG	424.00

REPLACEMENT NTC SENSOR

Fits Perlick chillers - use with Dixell Thermostat



Replacement NTC Sensor Probe

Part No.	Twin Lead	Probe	Price*
19G09-107	52" L	1/4" D x 5" L	22.95

LEG SET

Fits 4400 Series Power Paks



Leg Set

Set of Four, Adjustable Legs

Part No.	Adjustable Height	Price*
19G09-103	5-3/4" - 7-1/2"	81.95

PROCON 70 GPH PUMP

Works with most Perlick chillers that use clamp-on style pump



Procon Pump

Part No.	Price*
09H02-159	56.95

ROTARY THERMOSTAT

For PP Series Chillers



Rotary Thermostat

Part No.	Models	Price*
19G09-112	PP Series (ALL)	14.95

REPLACEMENT THERMOSTAT KIT

Use when old Probe has a white wire

Part No.	19G09-108
Price*	162.95

Includes:

- Thermostat
- 5" Probe & Probe plug-in adapter
- 1/4" Comp x 1/4" FPT Brass Fitting
- 5 Female spaded 15" connector wires
- Pair thermostat adjustment brackets
- Grounded plug adapter

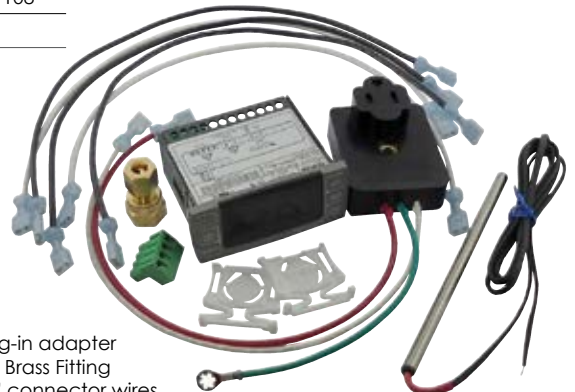

Perlick Quick Chill Glycol Chiller Parts and Accessories





GLYCOL CHILLERS *GLYCOL NOT INCLUDED

UBC GROUP is the largest manufacturer of draught beer chillers with 50,000 units manufactured annually for customers worldwide. UBC equipment has a proven record of reliability with affordable prices.

PURCHASE GLYCOL SEPARATELY – SEE PAGE 140

Sealed Bath 3/8*



- Procon Pump
- 3/8 HP compressor
- 2.9 gallon reservoir
- Digital Thermostat
- 115V / 60Hz
- Requires 15 amp dedicated circuit
- BTU/h 2600
- 28" L x 18" W x 13" H
- 95 lbs.

UP TO 125' RUN

19U07-115 **\$1120.00**

Kalinka Ice*



- Totton Pump
- 1/6 HP compressor
- 2 gallon reservoir
- Digital Thermostat
- 115V / 60 Hz
- Requires 10 amp dedicated circuit
- BTU/h 1150
- 16" L x 11" W x 22" H
- 19" L x 17" W x 17" H
- 38 lbs.

VERTICAL MODEL (not pictured)

UP TO 25' RUN

19U07-213 **\$667.00**

HORIZONTAL MODEL (pictured)

UP TO 25' RUN

19U07-113 **\$667.00**

Tayfun H35G*



- Totton or Procon Pump
- 3/8 HP compressor
- 5 gallon reservoir
- Digital Thermostat
- 115V / 60 Hz
- Requires 15 amp dedicated circuit
- BTU/h 2690
- 28" L x 19" W x 19" H
- Totton = 85 lbs.
- Procon = 95 lbs.

TOTTON PUMP UP TO 75' RUN

19U07-108 **\$960.00**

PROCON PUMP UP TO 125' RUN

19U07-112 **\$1120.00**

Tayfun 75G*



- Totton or Procon Pump
- 3/8 HP compressor
- 7 gallon reservoir
- Digital Thermostat
- 115V / 60 Hz
- Requires 15 amp dedicated circuit
- BTU/h 2690
- 15" L x 18" W x 29" H
- Totton = 85 lbs. / Procon = 95 lbs.

TOTTON PUMP UP TO 75' RUN

19U07-100 **\$960.00**

PROCON PUMP UP TO 125' RUN

19U07-105 **\$1120.00**

Sealed Bath 1/2*



- Procon Pump
- 1/2 HP compressor
- 2 gallon (sealed) reservoir
- Digital Thermostat
- 115V / 60 Hz
- Requires 20 amp dedicated circuit
- BTU/h 3500
- 18" L x 13" W x 28" H
- 113 lbs.

1/2 HP UP TO 200' RUN

19U07-110 **\$1387.00**

Extra 1/2 or Extra 3/4*



- Procon Pump
- 1/2 or 3/4 HP compressor
- 18 gallon reservoir
- Digital Thermostat
- 115V / 60 Hz
- Requires 20 amp dedicated circuit
- 1/2 = BTU/h 3900 / 3/4 = BTU/h 5500
- 24" L x 28" W x 30" H
- 1/2 HP = 155 lbs. / 3/4 HP = 161 lbs.

1/2 HP UP TO 250' RUN

19U07-102 **\$1387.00**

3/4 HP UP TO 450' RUN

19U07-109 **\$1760.00**

Commercial Beer Dispensers



1 Keg Dispenser
19B02-107

STANDARD FEATURES:

- Durable black vinyl laminated steel exteriors
- Stainless steel tops with drain line and drip trays
- Equipped with 3" insulated dispensing columns
- Dispensing columns have continuous cold air channeled through to ensure cold product.
- Stainless steel floor and reinforced door breakers
- Self-closing doors with locks and interior light.
- Balanced refrigeration system designed to operate 35-38°F.
- Refrigeration system utilizes ozone friendly R134a refrigerant.



NOTE: Towers are NOT included with dispensers. Contact your sales representative for more information.

Installation Kits for 19B02-107

Includes 5 lb. CO₂ cylinder, tap, double gauge regulator, air line with fittings.



Catalog No.	Description	Each
19D03-181	Sanke Universal with filled cylinder	134.95
19D03-182	Sanke Universal with empty cylinder	127.95

Catalog No.	Size	# of Doors	H.P.	Shipping Weight	Cu. Ft.	Box Dimensions		Each
						W x D x H		
19B02-107	1 Keg	1	1/5	167 lbs.	7.8	24" x 28" x 37 1/2"		1397.00
19B02-118	2 Keg	2	1/3	286 lbs.	19.8	50 1/2" x 27" x 37 1/4"		2367.00
19B02-119	2-3 Kegs	2	1/3	302 lbs.	23.7	59" x 27" x 37 1/4"		2476.00
19B02-120	3 Keg	2	1/3	364 lbs.	28	69" x 27" x 37 1/4"		2653.00
19B02-121	4 Keg	3	1/3	400 lbs.	32.3	79" x 27" x 37 1/4"		2851.00
19B02-122	5 Keg	3	1/3	426 lbs.	39.2	95" x 27" x 37 1/4"		3148.00
14B02-101	Caster assembly for 19B02-100, 102 & 103 - set of four swivel casters (2 pc have wheel locks)							197.95
14B02-100	Caster assembly for 19B02-104 & 105, - set of six swivel casters (3 pc have wheel locks)							218.95
11F09-101	Cover plate for column opening (6" square pre-drilled S/S)							11.95
11B02-100	Drain fitting for Beverage-Air & True (2-pc plastic)							6.62

Beer Dispensers, Deep Wells and Storage Coolers

Deep Well Bottle and Can Cooler

- Black vinyl laminated steel exterior.
- Stainless steel top, easy-glide lids and counter top with edge.
- Foamed-in-place polyurethane insulation for energy efficiency.
- Provides rapid chilling of product.
- Adjustable epoxy coated dividers
- Refrigeration system uses R134a refrigerant.



F.O.B. FOXX EQUIPMENT

Catalog No.	Ext. Dim. W x D x H	Bin Div.	No. Lids	Cu. Ft.	Can Case Capacity	Crated Wt.	HP	Each
19B02-112	50 x 26 1/2 x 33 3/4	3	2	13.3	23 3/4	259	1/3	1583.00
19B02-111	65 x 26 1/2 x 33 3/4	4	2	18.5	34 3/4	296	1/3	1867.00
19B02-110	95 x 26 1/2 x 33 3/4	6	4	28.5	55 3/4	425	1/2	2540.00

Back Bar Storage Cooler

- Black vinyl laminated steel exterior.
- Equipped with two inch stainless steel top.
- Stainless steel floor and reinforced door breakers.
- Self-closing doors with locks and interior light.
- Designed for rapid chilling of product.
- Uses R134a refrigerant.
- 115 volt



Catalog No.	Ext. Dim. W x D x H	No. Doors	No. Shlvs.	Cu. Ft.	Keg Capacity	Crated Wt.	HP	Each
19B02-114	59" x 27" x 37 1/4"	2	4	23.7	2	315	1/3	2419.00
19B02-115	69" x 27" x 37 1/4"	2	4	28	3	372	1/3	2603.00



Commercial Grade Beer Dispenser



- CAPACITY: 4 pc 1/6 barrel, 2 pc 1/4 barrel, or 1 pc 1/2 barrel
- Stainless steel top, interior and floor
- Removable stainless steel drip tray
- Built-in blower pushes cold air into the tower
- Dual evaporator fans provide excellent air circulation and maximize performance
- Magnetic seal door has built-in keyed lock
- Door adjustable to open left or right hand
- 2" foam-in-place insulation on entire unit provides high efficiency cooling
- Heavy-duty rubber casters/2 pc with locking brake
- **TOWER IS SOLD SEPARATELY**

- 1/5HP compressor
- 115V/60Hz
- Requires dedicated 20 amp circuit
- R134a refrigerant
- 24"W x 32"D x 40"H
- Weight: 150 lbs.

19U07-800

\$1182.00

For Replacement Thermostats



See page 106



Counter-Top Beer Dispenser Electric Model

Breeze-R

- Power required to operate
- No refrigeration required
- Flexibility for placement
- 17.5 lb. ice storage capacity
- C-tap faucet included
- 115V / 60 Hz
- 62 lb. empty weight
- 13" W x 25.5" H
- 20" D without tray
- 25.5" D with tray

19L01-101
\$1160.00



Counter-Top Beer Dispenser Ice Cooled Model

Breeze

- No power required to operate
- No refrigeration required
- Flexibility for placement
- No moving parts
- 22 lb. ice capacity
- 64 lb. empty weight
- 13" W x 16" H
- 20" D without tray

REQUIRED ACCESSORIES:
Faucet, connection hoses and fittings,
keg coupler, CO2 tank and regulator

19L01-102
\$620.00



Flash Chiller Cold Plates – Glycol Cooled

QUICKLY LOWERS TEMPERATURE OF BEVERAGE BEFORE EACH SERVING

Ideal for Problem Systems • Fully Insulated • Quiet • Non-Electric • 304 Grade S/S Lines

MULTIPLE APPLICATIONS INCLUDING: BEER, WINE AND LIQUOR

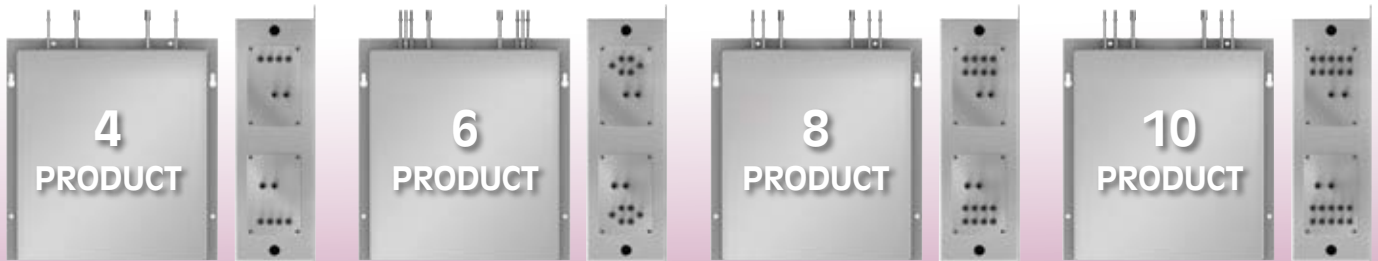

Catalog No.	# of Products	Glycol Lines (3/8" Stainless)	Product Lines (5/16" Stainless)	Weight	Dimensions	Each
13A02-100	4	48'	25'	74 lb.	20" x 21" x 6"	498.95
13A02-101	6	48'	18'	74 lb.	20" x 21" x 6"	538.95
13A02-102	8	48'	18'	78 lb.	20" x 21" x 6"	579.95
13A02-103	10	57'	18'	93 lb.	20" x 21" x 6"	681.95

Two Product Flash Chiller

Applications Include: Beer, Wine, Liquor

Kalinka 2

- 1 or 2 product lines
- Maximum distance 25'
- 1/6 HP compressor
- 6.6 lb. ice bank
- R134a refrigerant
- 115V / 60Hz
- 300 watt consumption
- Requires 15 amp dedicated circuit
- 55 lb. weight
- 18"W x 22"D x 12.5"H

19U07-303
\$819.00



Two Product Flash Chiller

Applications Include: Beer, Wine, Liquor

Tayfun V30

- 1 or 2 product lines
- Maximum distance 25'
- 1/4 HP compressor
- 19 lb. ice bank
- R134a refrigerant
- 115V / 60Hz
- 559 watt consumption
- Requires 15 amp dedicated circuit
- 87 lb. weight
- 11"W x 21"D x 22"H

19U07-304
\$989.00



Table Top Dispensers, Flash Chiller Cold Plates, Flash Chillers

SEE PAGE 47 FOR ADDITIONAL FLASH CHILLERS, OTHER MODELS ALSO AVAILABLE. CONTACT YOUR SALES REPRESENTATIVE FOR DETAILS



100% Propylene Glycol

HTF Formulation is a non-toxic, non-corrosive, biodegradable product, offering the highest level of protection and performance.

Catalog No.	Description	24+	12+	Each
19C07-146	Propylene Glycol, 1 gallon	18.95	19.95	20.50
Catalog No.	Description	4+	2+	Each
19C07-147	Propylene Glycol, 5 gallons	91.95	93.95	96.95
*19C07-148	Propylene Glycol, 55 gallons	775.00	799.00	820.00

*Dropship from manufacturer

Replacement Motors

1/3 HP

- 115V / 60Hz
- 1725 RPM
- 48Y FRAME
- RESILIENT BASE

BEST SELLER



09D08-102

12+ **\$98.95** 6+ 104.95 Ea. \$114.95

115 volt

- 1725 RPM
- 60 Hz

115/220 volt

- 1725/1425 RPM
- 60 & 50 Hz



48Y FRAME

AUTO THERMAL PROTECTION
RESILIENT BASE ON ALL MOTORS

SINGLE OR DUAL VOLTAGE AVAILABLE



3 Wire Service Cord

6' 10E03-100 \$5.95

8' 10E03-103 \$7.37

16 gauge

Catalog No.	Description	12+	6+	Each
09D08-101	1/4 HP (115V)	115.95	123.95	134.95
09D08-103	1/3 HP (115/220V)	137.95	147.95	160.95
09D08-105	1/2 HP (115V/220V)	152.95	163.95	178.95

Additional price breaks available on most items. Login to your website account or contact your sales representative for pricing.



3/8" barbs

1/3 HP MOTOR WITH PROCON

Add-On Pump Assembly

WILL FIT MOST GLYCOL CHILLERS ON THE MARKET

Resilient base motor • 100 GPH pump • 5 1/2' power cord • 115V / 60 Hz

19C07-101 **\$199.95**



12' Glycol Jumper Set

CONNECTS CHILLER (OUTSIDE OF WALK-IN) TO TRUNK LINE (INSIDE OF WALK-IN)

1/2" wall insulation and 3/8" barb fittings

19D03-103 **\$26.95**

Digital Thermostat

FOR UBC OR PERLICK CHILLERS



MODEL XR02CX

19U07-203

\$59.95



K-Way Glycol Chiller Parts



REPLACEMENT THERMOSTAT



REPLACEMENT CONDENSER FAN MOTOR

Catalog No.	Description	6+	3+	Each
19S05-124	Thermostat	50.95	52.95	54.95
Catalog No.	Description	12+	6+	Each
19R02-103	Motor (BC-3)	21.95	22.95	23.95
19Q06-115	Motor (BC-8)	-	80.95	84.95

Condenser Fan Motors

FITS: Motors fit several chillers on the market. Call your sales representative for proper UBC applications.



Catalog No.	Watts	Each
19U07-204	4 Watts	51.95
19U07-201	9 Watts	51.95
19U07-202	16 Watts	91.95
19U07-205	25 Watts	98.95

Agitator Pump/Motor

19U07-199

Fits Kalinka Model

\$109.95

19U07-200

Fits: Tayfun 35G, Tayfun 75G models equipped with the Totton pump/motor

\$109.95



Recirculating Glycol Trunkline Systems

LET FOXX CUSTOM BUILD A TRUNKLINE TO YOUR EXACT SPECIFICATIONS

HIGH QUALITY MATERIALS • SKILLED LABOR • AFFORDABLE PRICES

At the core of our trunklines is Bev-Seal Ultra® Series 235 tubing by Accuflex.

Bev-Seal Ultra® Series 235 POLYOLEFIN TUBE WITH INTERNAL DUAL BARRIER

INDIVIDUALLY NUMBERED AND COLOR CODED • PREVENTS FLAVOR PERMEATION • WORKS WITH PUNGENT FLAVORS



Accuflex

THE RECOGNIZED LEADER IN BEVERAGE TRANSFER PRODUCTS

Bev-Seal Ultra®



**ALL NEW DESIGN INCORPORATES AN ADDITIONAL MOISTURE BARRIER
ALLOWS FOR EASY "PEEL-BACK" OF ALL ADHESIVE TAPES**

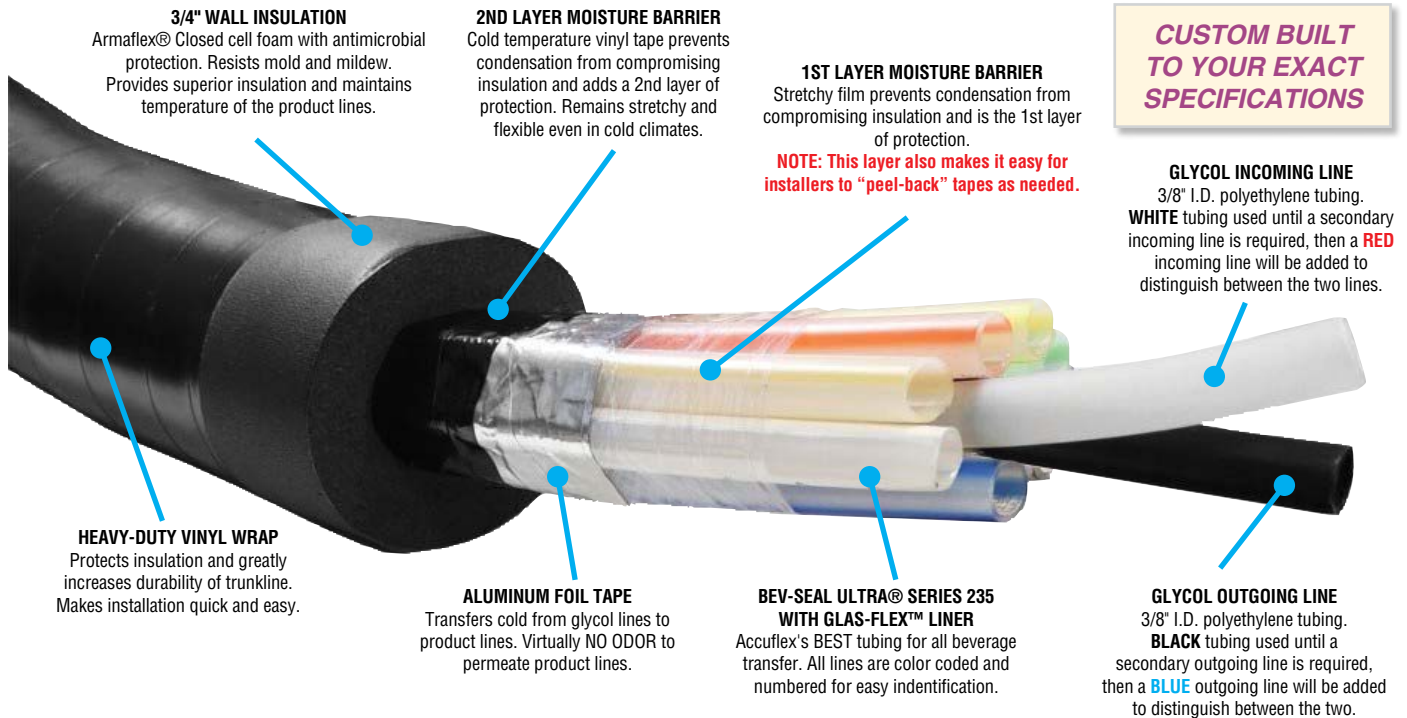

NOW UP TO 16 LINES AVAILABLE ON ALL SIZES

1/4" I.D. PRODUCT LINES			
Catalog No.	Beer Lines	Glycol Lines	Per Foot
19H03-380	2	2	5.95
19H03-381	3	2	6.95
19H03-382	4	2	7.95
19H03-383	5	2	8.95
19H03-384	6	2	9.95
19H03-385	8	2	10.95
19H03-386	10	2	11.95
19H03-387	12	4	12.95
19H03-388	14	4	13.95
19H03-389	16	4	14.95

5/16" I.D. PRODUCT LINES			
Catalog No.	Beer Lines	Glycol Lines	Per Foot
19H03-280	2	2	5.95
19H03-281	3	2	6.95
19H03-282	4	2	7.95
19H03-283	5	2	8.95
19H03-284	6	2	9.95
19H03-285	8	2	10.95
19H03-286	10	4	12.95
19H03-287	12	4	13.95
19H03-288	14	4	15.95
19H03-289	16	4	16.95

3/8" I.D. PRODUCT LINES			
Catalog No.	Beer Lines	Glycol Lines	Per Foot
19H03-180	2	2	5.95
19H03-181	3	2	6.95
19H03-182	4	2	7.95
19H03-183	5	2	8.95
19H03-184	6	2	9.95
19H03-185	8	2	10.95
19H03-186	10	4	12.95
19H03-187	12	4	14.95
19H03-188	14	4	15.95
19H03-189	16	4	16.95

Draft Beer Foam Preventers

A MUST FOR ALL LONG DRAW SYSTEMS!!! — WILL SAVE YOU TIME AND \$\$\$

Stops beer flow immediately after a keg empties. Keeps the supply lines full of beer instead of letting them fill with foam. Bartenders require less time to change kegs because the supply lines do not need to be cleared of gas and foam to get to “clear” beer. Servers do not have to wait to have their orders filled.

SAVES ABOUT 4 PINTS OF BEER PER KEG ON AVERAGE - based on a 125' run using 3/8" supply lines



CAN REVERSE MOUNT

WALL MOUNT
INLET: MALE OR FEMALE BEER THREAD
OUTLET: MALE BEER THREAD



CAN REVERSE MOUNT

WALL MOUNT
INLET: 3/8" O.D. PUSH-IN FITTING
OUTLET: 3/8" O.D. PUSH-IN FITTING



TECHO

③

WALL MOUNT
INLET: 3/8" BARB IN PUSH-IN FITTING
OUTLET: 3/8" BARB IN PUSH-IN FITTING



FOXX
EQUIPMENT COMPANY

④

WALL MOUNT
OVER-FLOW BOTTLE 32 oz.
STAINLESS STEEL HANGER

Ref. #	Catalog No.	Description	24+	12+	6+	Each
1	07B08-101	Inlet: Female Beer Thread	41.95	43.95	45.95	47.95
1	07B08-102	Inlet: Male Beer Thread	41.95	43.95	45.95	47.95
2	07B08-105	3/8" O.D. Push-in	41.95	43.95	45.95	47.95

Ref. #	Catalog No.	Description	25+	10+	5+	Each
3	07S07-150	3/8" Barbs or 3/8" Push-In	43.95	45.95	47.95	49.95

Ref. #	Catalog No.	Description	24+	12+	6+	Each
4	07D03-110	Overflow Bottle 32 oz.	16.95	17.95	18.95	19.95

Additional price breaks available on most items. Login to your website account or contact your sales representative for pricing.

Premium Stainless Steel Foam Preventers



CORE COMPONENTS LIMITED

CAP & PLASTIC BASE

USE 07G09-108 FOR THE RIGHT HAND MODEL

WALL MOUNT
INLET: 3/8" BARB OR PUSH-IN FITTING
OUTLET: 3/8" BARB OR PUSH-IN FITTING



CORE COMPONENTS LIMITED

WALL MOUNT
INLET: 3/8" BARB OR PUSH-IN FITTING
OUTLET: 3/8" BARB OR PUSH-IN FITTING



CORE COMPONENTS LIMITED

WALL MOUNT
INLET: MALE BEER THREAD
OUTLET: MALE BEER THREAD

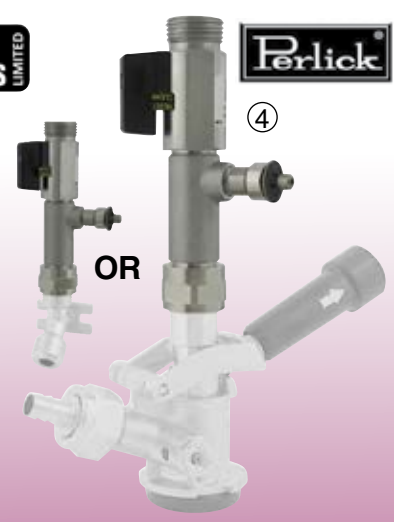

Perlick

④

OR

WALL / KEG MOUNT
INLET: FEMALE BEER THREAD SWIVEL
OUTLET: MALE BEER THREAD

Ref. #	Catalog No.	Description	24+	12+	6+	Each
1	07G09-109	3/8" Barbs or 3/8" Push-In	68.95	72.95	74.95	76.95
2	07G09-104	3/8" Barbs or 3/8" Push-In	92.95	97.95	101.95	103.95

Ref. #	Catalog No.	Description	24+	12+	6+	Each
3	07G09-103	3/8" Male Beer Thread	92.95	97.95	101.95	103.95
4	07C07-160	Female/Male Beer Thread	56.95	59.95	62.95	66.95

Draft Beer Foam Preventers



FLOJET® Beer Pump

CO₂ OR AIR DRIVEN – NEVER TOUCHES THE PRODUCT

Eliminates the need for gas blenders and nitrogen generators
 Works for short or long draw systems and up to 4 faucets
 Gas = 1/4" barb • Liquid = Stepped 3/8" or 1/2" barbs

Catalog No.	Description	12+	6+	Each
15F01-230	Beer Pump (with fittings)	52.95	56.95	60.95
15F01-231	Fitting Set 2/pkg. (Straight)	3.10	3.30	3.46
15F01-233	Fitting Set 2/pkg. (Elbow)	3.10	3.30	3.46



SHURflo® Beer Pump

CO₂ OR AIR DRIVEN – NEVER TOUCHES THE PRODUCT

Eliminates the need for gas blenders and nitrogen generators
 Works for short or long draw systems and up to 4 faucets
 Gas = 1/4" barb • Liquid = 3/8" barbs

Catalog No.	Description	12+	6+	Each
15C07-150	Beer Pump (with fittings)	47.95	50.95	53.95

SEE PAGE 23 FOR SELECTION OF AVAILABLE FITTINGS



Additional price breaks available on most items. Login to your website account or contact your sales representative for pricing.

Single In-Line Leak Indicator

A SMALL LEAK (1/2 CUBIC FOOT/HOUR) WASTES MORE GAS EACH DAY THAN IT TAKES TO DISPENSE TWO 1/2 BARREL KEGS

Easily tell when you have a gas leak and how big the leak is in order to determine if service is required.



19M09-300 **\$83.95**

Flow Reversal Valve

FLOJET®

WORKS WITH FLOJET BEER PUMP

Allows cleaning solutions to be run in alternating directions for improved system cleaning.



15F01-232
 24+ **\$23.95** 12+ \$24.95 Ea. \$25.95

Dual In-Line Leak Indicator

SAME AS THE SINGLE VERSION, BUT ALLOWS USER TO MONITOR TWO PRODUCT LINES INDEPENDENTLY

Provides user a significant savings when more than one gas line needs to be monitored.

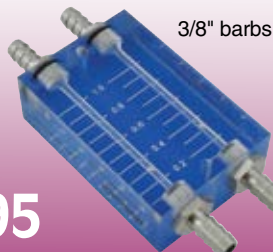

19M09-301 **\$101.95**

In-Line Flow Control

EASILY ADJUST BEER FLOW TO CORRECT POURING ISSUES
 ALLEN WRENCH ADJUSTMENT (wrench included)



07B03-161
 6+ **\$35.95** 3+ \$37.95 Ea. \$39.95

Beer Pumps, Cleaning Valves and Leak Indicators

Nitrogen/CO₂ Blenders



FOR USE WHERE OVER CARBONATION IS A PROBLEM OR FOR DISPENSING LOW CARBONATION "NITRO" BEERS

**Up to 15 kegs/hour per blend • Ends foaming
Consistent pouring • Guaranteed accuracy ± 2%
Inlet pressure 70 psi • 3/8" barb fittings inlets/outlets**

Blenders listed below in stock now!

Other custom blends available upon request



Single Blender

Includes built-in adjustable secondary regulators

- 19M09-100**
25% CO₂ & 75% N₂
- 19M09-101**
60% CO₂ & 40% N₂
- 19M09-102**
70% CO₂ & 30% N₂

\$590.95

Additional price breaks available on most items. Login to your website account or contact your sales representative for pricing.



Dual Blender

Includes built-in adjustable secondary regulators

- 19M09-200**
25% CO₂ & 75% N₂
60% CO₂ & 40% N₂
- 19M09-201**
25% CO₂ & 75% N₂
70% CO₂ & 30% N₂

\$851.95

DIFFERENT MIXTURES AVAILABLE UPON REQUEST



Triple Blender

Will require adjustable secondary regulators before the keg

- 19M09-210**
25% CO₂ & 75% N₂
60% CO₂ & 40% N₂
75% CO₂ & 25% N₂

\$937.95

Oil-Less Air Compressors

QUIET OPERATION – 62 DECIBELS

Normal conversation is 60 decibels

PERFECT FOR ALL BEVERAGE APPLICATIONS

- 5/8 HP motor
- 110V/60Hz voltage
- 2.6 CFM output
- Maximum pressure 100 psi
- Operating pressure 70-100 psi
- 2 gallon tank size
- Includes filter/regulator with gauge
- Dimensions:
16.5" L x 13" W x 16" H
- Shipping weight 45 lbs.

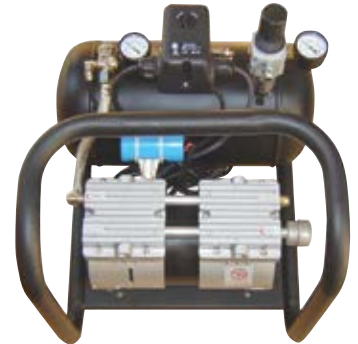

WILL NOT "WALK" ACROSS FLOOR DURING OPERATION

DROP SHIPS FROM MANUFACTURER ONLY

- 19B01-100** Compressor only **\$523.95**
- 19B01-101** Compressor with auto drain valve **\$578.95**
that has adjustable timer

Refractometers

AUTOMATIC TEMPERATURE COMPENSATED

Check glycol levels in open bath systems.

Ratio: 2-1 is 24 / Ratio: 1-1 is 34

Scale 0 to 32 brix • Accurate to 1/4 of 1%

ECONOMY MODEL 20C04-110



- 20+ \$34.95**
- 10+ \$36.95**
- 5+ \$38.95**
- Ea. \$40.95**

INDUSTRIAL MODEL 20C04-111



- 20+ \$39.95**
- 10+ \$41.95**
- 5+ \$44.95**
- Ea. \$47.95**

LIGHTED MODEL 20C04-112



- 20+ \$39.95**
- 10+ \$41.95**
- 5+ \$44.95**
- Ea. \$47.95**

Gas Blenders, Air Compressors and Refractometers



Forced Air Blowers and Mounting Brackets

BLOWERS AND BRACKETS SOLD SEPARATELY

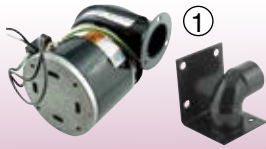

12 CFM BLOWER & BRACKET 1-1/4" dia.

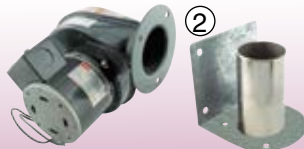

50 CFM BLOWER & BRACKET 2-1/2" dia.



131 CFM BLOWER & BRACKET 3" dia.



273 CFM BLOWER & BRACKET 3" dia.

Ref. #	Catalog No.	Description	Each
1	19E03-108	Blower (12 CFM)	79.95
1	19F09-130	Bracket (12 CFM)	13.95
2	19E03-109	Blower (50 CFM)	97.95
2	19F09-131	Bracket (50 CFM)	15.95

Ref. #	Catalog No.	Description	Each
3	19E03-110	Blower (131 CFM)	122.95
3	19F09-132	Bracket (131 CFM)	16.95
4	19E03-114	Blower (273 CFM)	132.95
4	19F09-133	Bracket (273 CFM)	20.95

Column Connection Accessories

FOR FORCED AIR SYSTEMS

Air separator and mounting collar attaches below the counter to connect column to dual hose air flow system. Air separator and air baffle direct incoming cold air to interior of column. Return flow is redirected to outer hose by the air separator.

Ref. #	Catalog No.	Description	Each
1	19G09-106	Air Baffle	10.95
2	19G09-104	Air Separator/Mounting Collar	190.95
3	19G09-105	Insulated Elbow	92.95



AIR BAFFLE
(fits into column)
2-1/2" wide blade



AIR SEPARATOR AND MOUNTING COLLAR
3" diameter into 4" diameter



INSULATED ELBOW
3" diameter into 4" diameter
(requires 10" clearance)

Forced Air Systems

PURCHASE EACH COMPONENT SEPARATELY

PVC Tube with Rigid PVC Helix

TOUGH • DURABLE • SLIDES EASILY



PICTURED:
19A01-168 / 19A01-172 / 19D05-109

Catalog No.	Description	50'+	25'+	Ft.
19A01-169	1" O.D. Vinyl	1.75	1.85	1.95
19A01-170	1-1/2" O.D. Vinyl	2.45	2.60	2.75
19A01-168	2" O.D. Vinyl	3.95	4.25	4.50
19A01-171	3" O.D. Vinyl	5.05	5.40	5.65
19A01-172	4" O.D. Vinyl	6.55	6.95	7.30

Armaflex® Foam Tube Insulation

SOLD IN 6' SECTIONS ONLY

Catalog No.	Wall	ID	36'+	18'+	6'+
19D05-113	1/2"	1-1/8"	0.82	0.88	0.92
19D05-111	1/2"	1-5/8"	1.13	1.20	1.26
19D05-101	1/2"	2-1/8"	1.47	1.56	1.64
19D05-110	1/2"	3-1/2"	2.52	2.67	2.80
19D05-109	1/2"	4-1/2"	3.74	3.97	4.16



Ref. #	Catalog No.	Description	1000+	500+	Each
1	14Q02-112	5.5" Standard (Black)	0.04	0.05	0.06
1	14Q02-104	7.5" Standard (Natural)	0.05	0.06	0.07
1	14Q02-110	7.5" Standard (Black)	0.06	0.07	0.10
1	14Q02-102	15" Standard (Natural)	0.13	0.14	0.18
1	14Q02-108	15" Standard (Black)	0.14	0.15	0.20
1	14Q02-113	36" Standard (Black)	0.28	0.30	0.41
2	14Q02-105	7.5" Screw Mount (Natural)	0.10	0.11	0.13
2	14Q02-111	7.5" Screw Mount (Black)	0.11	0.12	0.15
2	14Q02-101	14.5" Screw Mount (Natural)	0.28	0.30	0.40
2	14Q02-107	14.5" Screw Mount (Black)	0.36	0.38	0.50



Self-Locking Cable Ties

Heavy duty nylon with positive lock and non-slip.

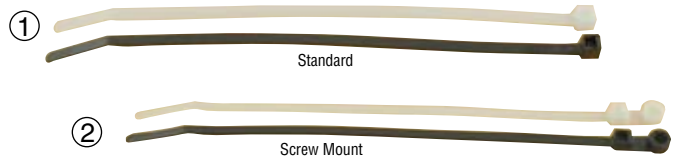

Basic Polished Stainless Steel Column

ALL COLUMNS INCLUDE: CHROME PLATED FAUCETS, KNOBS, 3/16" NSF BEER LINES, TAIL PIECES, HEX NUTS & WASHERS

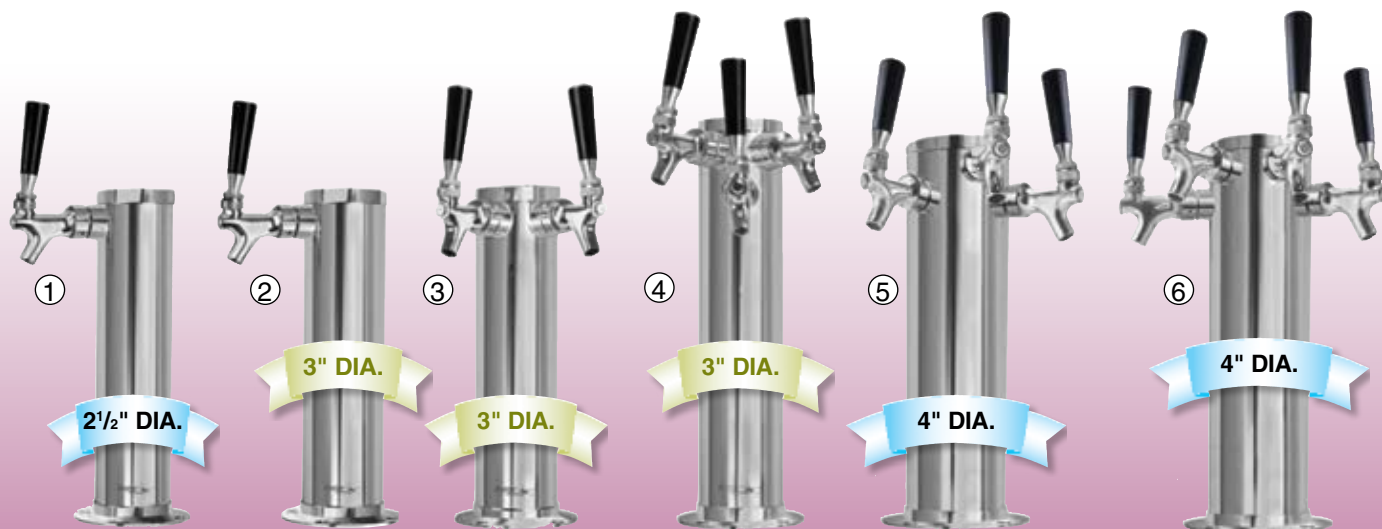

AIR COOLED

Ref. #	Catalog No.	Faucets	Height	4+	Each
1	11B03-191	1	12"	43.95	45.95
2	11B07-100	1	12"	57.95	61.95
3	11B07-103	2	12"	81.95	88.95
4	11B07-105	3	14-3/4"	120.95	125.95
5	11B03-192	3	14-3/4"	142.95	148.95
6	11B03-195	4	14-3/4"	159.95	165.95

GLYCOL COOLED

Ref. #	Catalog No.	Faucets	Height	4+	Each
1	-	-	-	-	-
2	19H03-100	1	12"	93.95	100.95
3	19H03-103	2	12"	115.95	123.95
4	19H03-105	3	14-3/4"	161.95	172.95
5	19H03-194	3	14-3/4"	184.95	197.95
6	19H03-198	4	14-3/4"	205.95	219.95

Additional price breaks available on most items. Login to your website account or contact your sales representative for pricing.

Basic Polished Stainless Steel PVD Gold Columns

ALL GLYCOL COLUMNS HAVE: 3/8" COPPER COOLING LOOP ATTACHED TO SHANK(S) WITH 3/8" BARBED ENDS



AIR COOLED

Ref. #	Catalog No.	Faucets	Height	4+	Each
1	11B03-151	1	12"	82.95	84.95
2	11B03-153	2	12"	120.95	123.95
3	11B03-190	3	14-3/4"	149.95	153.95

GLYCOL COOLED

Ref. #	Catalog No.	Faucets	Height	4+	Each
1	19H03-191	1	12"	128.95	137.95
2	19H03-193	2	12"	165.95	177.95
3	19H03-197	3	14-3/4"	190.95	203.95

Basic Column Standards



Premium NSF Columns

INCLUDES: FAUCETS, 3/16" BEER LINES, TAIL PIECES, HEX NUTS & WASHERS



NSF
**CHROME PLATED
 FAUCETS
 AND SHANKS
 WITH A
 POLISHED
 STAINLESS STEEL
 BASE**



NSF
**GLYCOL COLUMNS
 HAVE A
 3/8" DIAMETER
 COPPER LOOP
 FITTED WITH
 3/8" BARBED
 ENDS**



AIR COOLED					
Catalog No.	Faucets	Diameter	Height	4+	Each
11B03-152	1	3"	12"	72.95	75.95
11B03-154	2	3"	12"	100.95	104.95
11B03-189	3	3"	14-3/4"	165.95	172.95

GLYCOL COOLED					
Catalog No.	Faucets	Diameter	Height	2+	Each
19H03-190	1	3"	12"	113.95	121.95
19H03-192	2	3"	12"	141.95	151.95
19H03-196	3	3"	14-3/4"	207.95	222.95

Additional price breaks available on most items. Login to your website account or contact your sales representative for pricing.

Premium NSF Columns (304 S/S Contact)

INCLUDES: FAUCETS, 3/16" BEER LINES, TAIL PIECES, HEX NUTS & WASHERS

FAUCET KNOB SOLD SEPARATELY



**304
 S/S**
**304 S/S CONTACT
 INCLUDES
 FAUCET, SHANKS
 AND TAILPIECES
 COLUMN IS
 POLISHED
 STAINLESS STEEL**



**304
 S/S**
**GLYCOL COLUMNS
 HAVE A
 3/8" DIAMETER
 COPPER LOOP
 FITTED WITH
 3/8" BARBED
 ENDS**



AIR COOLED					
Catalog No.	Faucets	Diameter	Height	2+	Each
11E03-101	1	3"	12"	81.95	85.95
11E03-102	2	3"	12"	95.95	99.95
11E03-103	3	3"	14-3/4"	155.95	162.95

GLYCOL COOLED					
Catalog No.	Faucets	Diameter	Height	2+	Each
11E03-111	1	3"	12"	123.95	128.95
11E03-112	2	3"	12"	140.95	146.95
11E03-113	3	3"	14-3/4"	203.95	212.95

Premium NSF Columns

Growler Filling Columns (16" Tall)

TALLER DESIGN ALLOWS FOR EASY FILLING OF VARIOUS SIZES AND TYPES OF GROWLERS

3" DIAMETER CHROMED BRASS BASE • STANDARD CHROMED FAUCETS • KNOBS SOLD SEPARATELY

2 FAUCET MODELS

11Q09-440 (Air)

3+ **\$126.95**

Ea. \$131.95

2 FAUCET



3 FAUCET MODELS

11Q09-442 (Air)

3+ **\$147.95**

Ea. \$153.95

3 FAUCET



22" Tall Wall Mount Growler Filling Stations

TALLER DESIGN ALLOWS FOR EASY FILLING OF VARIOUS SIZES AND TYPES OF GROWLERS

2 – 8 FAUCETS
AVAILABLE
(WITH BUILT-IN RINSER)



Growler Filling Stations

SHANKS, FAUCETS, KNOBS ARE SOLD SEPARATELY

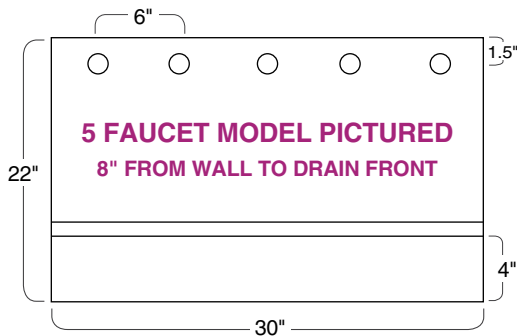

Catalog No.	Faucets	Length	Width	Height	Each
11C01-100	2	12"	8"	22"	476.95
11C01-101	3	18"	8"	22"	501.95
11C01-102	4	24"	8"	22"	521.95
11C01-103	5	30"	8"	22"	670.95
11C01-104	6	36"	8"	22"	684.95
11C01-105	7	42"	8"	22"	701.95
11C01-106	8	48"	8"	22"	735.95



Chrome Plated Brass Column Shanks

				
3/16" Bore 1/4" Barb	1/4" Bore 3/16" Barb	3/16" Bore 1/4" Barb	1/4" Bore 5/16" Barb Fits 1/4" vinyl	1/4" Bore 5/16" Barb
COMPRESSION FITTING/REMOVABLE BARB			WELDED IN PLACE BARB	
12B03-196 6+ \$23.95 3+ \$24.95 Ea. \$25.95	12K03-200 6+ \$13.95 3+ \$14.95 Ea. \$15.95	12K03-202 6+ \$8.50 3+ \$8.95 Ea. \$9.50	12K03-204 6+ \$9.50 3+ \$9.95 Ea. \$10.50	12B03-193 6+ \$20.95 3+ \$22.95 Ea. \$22.95



304 Grade Stainless Steel Column Shanks



			
3/16" Bore 1/4" Barb	1/4" Bore 5/16" Barb Fits 1/4" vinyl	1/4" Bore 5/16" Barb Fits 1/4" vinyl	3/16" Bore 1/4" Barb
WELDED IN PLACE BARBED			
12K03-201 6+ \$10.95 3+ \$11.50 Ea. \$11.95	12K03-205 6+ \$12.95 3+ \$13.50 Ea. \$13.95	12B03-201 6+ \$26.95 3+ \$27.95 Ea. 29.95	12B03-293 6+ \$28.95 3+ \$27.95 Ea. \$28.95

Additional price breaks available on most items. Login to your website account or contact your sales representative for pricing.

Expansion Kits for 3" Diameter Columns

KITS INCREASE THE NUMBER OF DISPENSING FAUCETS TO ANY EXISTING 3" DIAMETER COLUMN



DOUBLE TO TRIPLE FAUCET

KROME DISPENSE BRAND			
Catalog No.	Description	6+	Each
11K33-104	Includes 1 Shank	20.95	21.95

ABECO BRAND			
Catalog No.	Description	5+	Each
11A33-104	Includes 1 Shank	45.95	48.95
11A33-101	Shank not included	31.95	33.95



SINGLE TO TRIPLE FAUCET

KROME DISPENSE BRAND			
Catalog No.	Description	5+	Each
11K33-106	Includes 2 Shanks	19.95	20.95

ABECO BRAND			
Catalog No.	Description	5+	Each
11A33-106	Includes 2 Shanks	60.95	65.95



SINGLE TO DOUBLE FAUCET

KROME DISPENSE BRAND			
Catalog No.	Description	6+	Each
11K33-110	Includes 1 Shank	15.95	17.95

ABECO BRAND			
Catalog No.	Description	5+	Each
11A33-110	Includes 1 Shank	52.95	55.95
11A33-108	Shank not included	37.95	40.95



BRASS EXPANSION KITS AVAILABLE UPON REQUEST

ALL KITS INCLUDE: A DRILL BIT AND THREE MOUNTING SCREWS

Changes Double Faucet Tower into a Triple Faucet Tower

Changes Single Faucet Tower into a Triple Faucet Tower

Changes Single Faucet Tower into a Double Faucet Tower

Clamp-on Stainless Steel Drain

**FITS ALL
3" DIAMETER
COLUMNS**

**USED TO DISPENSE
FROM A TEMPORARY
LOCATION**

- Heavy-duty
- All stainless construction
- C-Clamp has up to 3-7/8" height clearance, 3-1/2" deep clearance and is reinforced
- Removable stainless steel drain grate measures 5" W x 7-1/2" L
- 1/2" plastic drain fitting

**COLUMN SOLD
SEPARATELY**



11A03-102

\$99.95

**EASILY
ATTACHES
TO MOST
COUNTERS**

Mounting Hardware for Columns



#10-32 S/S BOLT / WASHER / NUT ASSEMBLY

Catalog No.	Description	25+	10+	Each
04T03-110	3-1/2" Length Assembly	0.80	0.85	0.95
04T03-111	4" Length Assembly	1.00	1.05	1.25

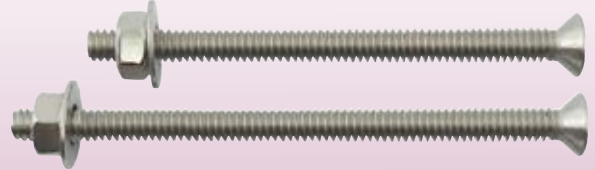

1/4"-20 S/S BOLT / WASHER / NUT ASSEMBLY

Catalog No.	Description	25+	10+	Each
04T03-210	3-1/2" Length Assembly	0.80	0.85	0.95
04T03-211	4" Length Assembly	1.00	1.05	1.25



STAINLESS STEEL SCREWS

Catalog No.	Description	25+	10+	Each
04T03-302	#8 x 1-1/4" Length	0.10	0.12	0.14
04T03-303	#10 x 1-1/2" Length	0.16	0.18	0.20

SOLID BRASS SCREWS

Catalog No.	Description	25+	10+	Each
04T03-300	#8 x 1-1/4" Length	0.19	0.20	0.21
04T03-301	#10 x 1-1/2" Length	0.28	0.29	0.31

Column Replacement Parts – Will Fit Most Columns

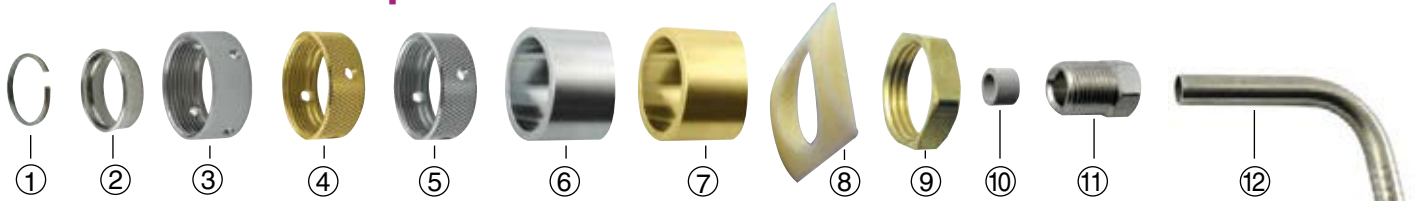

Additional price breaks available on most items. Login to your website account or contact your sales representative for pricing.



Ref.#	Catalog No.	Description	Each
1	12B03-178	Snap Ring (for Shank Sleeve)	0.26
2	12B03-179	Sleeve, Shank	0.98
3	12K03-181	Coupling Ring, Faucet (Chrome) Smooth	1.50
4	12B03-180	Coupling Ring, Faucet (PVD Gold) Knurled	2.58
5	12B03-181	Coupling Ring, Faucet (Chrome) Knurled	2.15
6	12B03-160	Spacer, Column Shank (Chrome) Plastic	2.87
7	12B03-159	Spacer, Column Shank (PVD Gold) Plastic	7.48
8	12B03-161	Flange, Column (Nylon)	0.90
9	12B03-162	Lock Nut, Column Shank (Brass)	1.95

Ref.#	Catalog No.	Description	Each
-	-	-	-
10	12B03-226	Grommet (for Compression Shanks)	0.99
11	12B03-186	Compression Nut (for Compression Shanks)	1.24
12	12B03-195	90° 3/16" Barb (for Compression Shanks)	1.95
13	12B03-188	Dome, 2-1/2" Diameter (Chrome)	2.95
14	12K03-207	Dome, 3" Diameter (Chrome)	5.95
15	12K03-206	Dome, 3" Diameter (Brass)	9.95
16	12B03-155	Dome, 4" Diameter (Chrome)	6.95
17	12B03-233	Mounting Gasket (for 3" Diameter Columns)	1.15

Premium NSF "T" and Pass-Thru Towers

WITH CHROME PLATED FAUCETS AND SHANKS – S/S EXTERIOR

OVERALL HEIGHT 15" • FAUCET CLEARANCE 10-1/2" • FAUCETS ON 3" CENTERS • KNOBS SOLD SEPARATELY

"T" TOWER 3" ROUND COLUMN

	Catalog No.	Faucets	Width	Each
AIR COOLED	11B03-258	3	12"	287.00
	11B03-260	4	12"	307.00
	11B03-263	5	15"	355.00
	11B03-265	6	19"	430.00
	11B03-266	8	19"	519.00
	Catalog No.	Faucets	Width	Each
"MAX-CHILL" GLYCOL SYSTEM	11B03-113	3	12"	369.00
	11B03-104	4	12"	416.00
	11B03-105	5	15"	491.00
	11B03-106	6	19"	571.00
	11B03-108	8	19"	729.00

PASS-THRU TOWER 3" ROUND COLUMN

	Catalog No.	Faucets	Width	Each
AIR COOLED	11A03-266	8	24"	595.00
	11A03-271	10	30"	670.00
	11A03-274	12	37"	801.00
	Catalog No.	Faucets	Width	Each
"MAX-CHILL" GLYCOL SYSTEM	11A03-268	8	24"	781.00
	11A03-273	10	30"	932.00
	11A03-276	12	36"	1120.00

"T" TOWER 4" SQUARE COLUMN

S/S	Catalog No.	Faucets	Width	Each
AIR COOLED	11B03-401	3	12"	375.00
	11B03-402	4	12"	396.00
	11B03-403	5	15"	445.00
	11B03-404	6	19"	519.00
	11B03-405	8	19"	604.00
S/S	Catalog No.	Faucets	Width	Each
"MAX-CHILL" GLYCOL SYSTEM	11B03-501	3	12"	457.00
	11B03-502	4	12"	505.00
	11B03-503	5	15"	580.00
	11B03-504	6	19"	657.00
	11B03-505	8	19"	814.00
PVD BRASS	Catalog No.	Faucets	Width	Each
AIR COOLED	11B03-411	3	12"	696.00
	11B03-412	4	12"	768.00
	11B03-413	5	14-3/4"	873.00
	11B03-414	6	20-1/4"	932.00
PVD BRASS	Catalog No.	Faucets	Width	Each
"MAX-CHILL" GLYCOL SYSTEM	11B03-511	3	12"	750.00
	11B03-512	4	12"	873.00
	11B03-513	5	14-3/4"	1005.00
	11B03-514	6	20-1/4"	1090.00

PASS-THRU TOWER 4" SQUARE COLUMN

S/S	Catalog No.	Faucets	Width	Each
AIR COOLED	11A03-403	8	24"	742.00
	11A03-404	10	30"	840.00
	11A03-405	12	36"	972.00
S/S	Catalog No.	Faucets	Width	Each
"MAX-CHILL" GLYCOL SYSTEM	11A03-503	8	24"	952.00
	11A03-504	10	30"	1103.00
	11A03-505	12	36"	1287.00
PVD BRASS	Catalog No.	Faucets	Width	Each
AIR COOLED	11A03-413	8	33-1/4"	1328.00
	11A03-414	10	33-1/4"	1475.00
	11A03-415	12	33-1/4"	1600.00
PVD BRASS	Catalog No.	Faucets	Width	Each
"MAX-CHILL" GLYCOL SYSTEM	11A03-513	8	33-1/4"	1526.00
	11A03-514	10	33-1/4"	1718.00
	11A03-515	12	33-1/4"	1897.00



CHROME PLATED BRASS TOWER SHANKS

Replacement Shank Assemblies with welded 3/16" Barb Elbow



8-FAUCET "T" TOWERS HAVE FAUCETS ON 2-3/8" CENTERS

Catalog No.	Length	12+	6+	Each
12B03-218	1-3/4"	15.95	16.50	17.25
12A03-118	3"	-	17.95	18.50



COLUMN SPACING ON CENTERS

8 Faucets = 15-1/2"
10 or 12 Faucets = 21-1/2"



ALL MODELS AVAILABLE WITH "MAX-CHILL" GLYCOL SYSTEM



COLUMN SPACING ON CENTERS

8 Faucets = 15-1/2"
10 or 12 Faucets = 21-1/2"

8-FAUCET "T" TOWERS HAVE FAUCETS ON 2-3/8" CENTERS

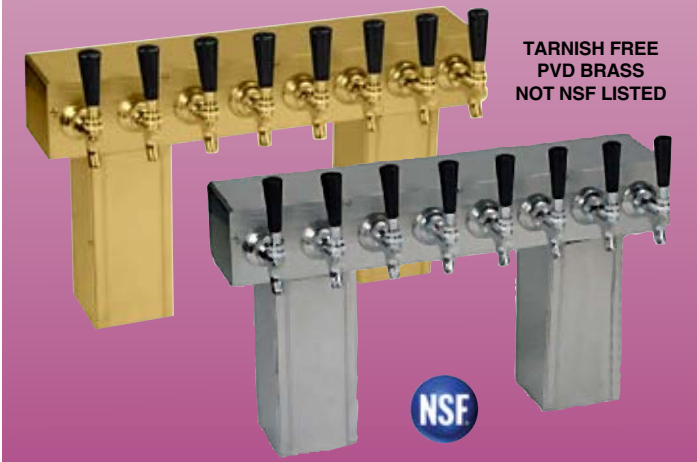

TARNISH FREE PVD BRASS NOT NSF LISTED

Premium NSF "T" and Pass-Thru Towers (304 S/S Contact)

WITH 304 GRADE STAINLESS STEEL FAUCETS AND SHANKS – S/S EXTERIOR

OVERALL HEIGHT 15" • FAUCET CLEARANCE 10-1/2" • FAUCETS ON 3" CENTERS • KNOBS SOLD SEPARATELY

304 GRADE STAINLESS STEEL TOWER SHANKS



Replacement Shank Assemblies with welded 3/16" Barb Elbow

Catalog No.	Length	12+	6+	Each
12B03-318	1-3/4"	26.95	27.95	28.95
12A03-218	3"	30.95	31.95	33.95



8-Faucet "T" Towers have faucets on 2-3/8" centers



"T" TOWER 3" ROUND COLUMN

Catalog No.	Faucets	Width	Each	
11B03-267	3	12"	389.00	AIR COOLED
11B03-268	4	12"	444.00	
11B03-269	5	15"	525.00	
11B03-270	6	19"	635.00	
11B03-271	8	19"	781.00	
Catalog No.	Faucets	Width	Each	
11B03-272	3	12"	471.00	"MAX-CHILL" GLYCOL SYSTEM
11B03-273	4	12"	553.00	
11B03-274	5	15"	662.00	
11B03-275	6	19"	768.00	
11B03-276	8	19"	991.00	

PASS-THRU TOWER 3" ROUND COLUMN

Catalog No.	Faucets	Width	Each	
11B03-277	8	24"	834.00	AIR COOLED
11B03-278	10	30"	998.00	
11B03-279	12	37"	1195.00	
Catalog No.	Faucets	Width	Each	
11B03-280	8	24"	1044.00	"MAX-CHILL" GLYCOL SYSTEM
11B03-281	10	30"	1260.00	
11B03-282	12	36"	1425.00	



COLUMN SPACING ON CENTERS
8 Faucets = 15-1/2"
10 or 12 Faucets = 21-1/2"



"T" TOWER 4" SQUARE COLUMN

Catalog No.	Faucets	Width	Each	S/S
11B03-283	3	12"	478.00	AIR COOLED
11B03-284	4	12"	532.00	
11B03-285	5	15"	614.00	
11B03-286	6	19"	696.00	
11B03-287	8	19"	867.00	
Catalog No.	Faucets	Width	Each	S/S
11B03-288	3	12"	560.00	"MAX-CHILL" GLYCOL SYSTEM
11B03-290	4	12"	641.00	
11B03-291	5	15"	722.00	
11B03-292	6	19"	854.00	
11B03-293	8	19"	1077.00	
Catalog No.	Faucets	Width	Each	PVD BRASS
11B03-294	3	12"	768.00	AIR COOLED
11B03-295	4	12"	900.00	
11B03-296	5	14-3/4"	1037.00	
11B03-297	6	20-1/4"	1129.00	
Catalog No.	Faucets	Width	Each	
11B03-298	3	12"	847.00	"MAX-CHILL" GLYCOL SYSTEM
11B03-299	4	12"	950.00	
11B03-300	5	14-3/4"	1100.00	
11B03-301	6	20-1/4"	1211.00	

ALL MODELS AVAILABLE WITH "MAX-CHILL" GLYCOL SYSTEM



COLUMN SPACING ON CENTERS
8 Faucets = 15-1/2"
10 or 12 Faucets = 21-1/2"



PASS-THRU TOWER 4" SQUARE COLUMN

Catalog No.	Faucets	Width	Each	S/S
11B03-302	8	24"	1005.00	AIR COOLED
11B03-303	10	30"	1169.00	
11B03-304	12	36"	1285.00	
Catalog No.	Faucets	Width	Each	S/S
11B03-305	8	24"	1215.00	"MAX-CHILL" GLYCOL SYSTEM
11B03-306	10	30"	1347.00	
11B03-307	12	36"	1582.00	
Catalog No.	Faucets	Width	Each	PVD BRASS
11B03-308	8	33-1/4"	1575.00	AIR COOLED
11B03-309	10	33-1/4"	1779.00	
11B03-310	12	33-1/4"	1971.00	
Catalog No.	Faucets	Width	Each	PVD BRASS
11B03-311	8	33-1/4"	1773.00	"MAX-CHILL" GLYCOL SYSTEM
11B03-312	10	33-1/4"	2026.00	
11B03-313	12	33-1/4"	2267.00	

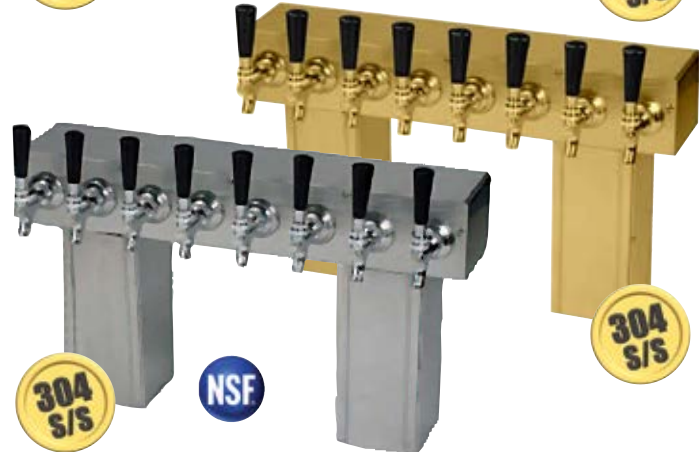

Premium NSF "T" and Pass-Thru Towers (304 S/S Contact)

The "Big Boy" Stainless Steel Pass-Thru Towers

HEAVY DUTY • RELIABLE SERVICE • WELL INSULATED • GLYCOL READY

4" diameter pedestals
10-1/2" faucet clearance
15" height x 7" width

PURCHASE KNOBS SEPARATELY

Catalog No.	Faucets	Overall Length	Pedestals on centers	Faucets on centers	Each
11Q09-600	14	45"	29"	3.2"	1124.95
11Q09-601	16	45"	29"	3"	1224.95
11Q09-602	18	60"	36"	3.3"	1349.95
11Q09-603	20	60"	36"	3"	1456.95
11Q09-604	24	72"	44"	3"	1813.95



NOTE: All beer and glycol lines are split with half down each leg.

AFFORDABLY PRICED

Dual-Sided Stainless Steel "T" and Pass-Thru Towers

HEAVY DUTY • RELIABLE SERVICE • WELL INSULATED • GLYCOL READY

NOTE: All product and glycol lines are split with half down each leg.

PURCHASE KNOBS SEPARATELY

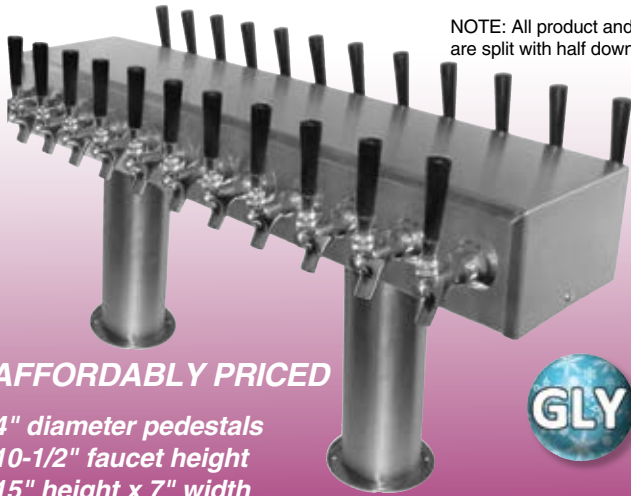

AFFORDABLY PRICED

4" diameter pedestals
10-1/2" faucet height
15" height x 7" width

"T" TOWERS (ONE PEDESTAL)					
Catalog No.	Faucets	Overall Length	Pedestals on centers	Faucets on centers	Each
11Q09-500	12 (6/side)	18"	N/A	3"	924.95
11Q09-501	16 (8/side)	20"	N/A	2.5"	1099.95

PASS-THRU TOWERS (TWO PEDESTALS)					
Catalog No.	Faucets	Overall Length	Pedestals on centers	Faucets on centers	Each
11Q09-503	20 (10/SIDE)	30"	21-1/2"	3"	1312.95
11Q09-504	24 (12/SIDE)	36"	21-1/2"	3"	1449.95
11Q09-505	28 (14/SIDE)	45"	29"	3.2"	1706.95
11Q09-506	32 (16/SIDE)	45"	29"	3"	1837.95

Basic Stainless Steel "T" and Pass-Thru Towers

HEAVY DUTY • RELIABLE SERVICE • WELL INSULATED • GLYCOL READY

PURCHASE KNOBS SEPARATELY

"T" TOWERS (ONE PEDESTAL)					
Catalog No.	Faucets	Overall Length	Pedestals on centers	Faucets on centers	Each
11Q09-703	4	12"	N/A	3"	345.95
11Q09-705	6	18"	N/A	3"	477.95
11Q09-706	8	20"	N/A	2-1/2"	609.95

PASS-THRU TOWERS (TWO PEDESTALS)					
Catalog No.	Faucets	Overall Length	Pedestals on centers	Faucets on centers	Each
11Q09-707	6	24"	15-1/2"	4-1/2"	522.95
11Q09-708	8	24"	15-1/2"	3"	642.95
11Q09-709	10	30"	21-1/2"	3"	770.95
11Q09-710	12	36"	21-1/2"	3"	910.95



AFFORDABLY PRICED

3" diameter pedestals
10-1/2" faucet clearance
15" height x 7" width

"Big Boy," Dual-Sided and Basic "T" and Pass-Thru Towers

Under Bar and Wall Mount Stainless Steel Dispensers

With Chrome Plated Brass Faucets and Shanks

AIR OR GLYCOL SYSTEMS AVAILABLE • HEAVY-DUTY 16 GAUGE STAINLESS STEEL CONSTRUCTION

INCLUDES: Station, faucets, shanks, mounting box. Air systems include a 3" O.D. brass tube for easy connection to flex-hose (8 to 12 faucets have 2 tubes)

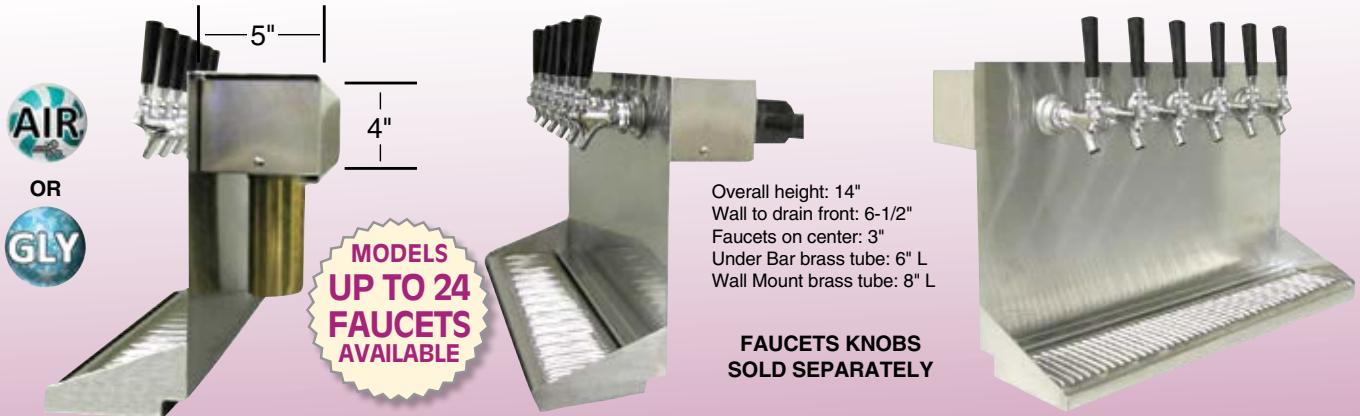

SIDE VIEW OF UNDER BAR

SIDE VIEW OF WALL MOUNT

FRONT VIEW OF EITHER UNDER BAR OR WALL MOUNT

UNDER BAR MOUNT DISPENSERS

Catalog No.	Faucets	Length	Air/Glycol	Each
11Q09-102	2 Faucet	15"	Air	452.95
11Q09-112	2 Faucet	15"	Glycol	502.95
11Q09-103	3 Faucet	15"	Air	476.95
11Q09-113	3 Faucet	15"	Glycol	538.95
11Q09-104	4 Faucet	15"	Air	506.95
11Q09-114	4 Faucet	15"	Glycol	589.95
11Q09-105	5 Faucet	24"	Air	571.95
11Q09-115	5 Faucet	24"	Glycol	674.95
11Q09-106	6 Faucet	24"	Air	594.95
11Q09-116	6 Faucet	24"	Glycol	718.95
11Q09-108	8 Faucet	30"	Air	789.95
11Q09-118	8 Faucet	30"	Glycol	948.95
11Q09-110	10 Faucet	36"	Air	1013.95
11Q09-120	10 Faucet	36"	Glycol	1212.95
11Q09-122	12 Faucet	48"	Air	1124.95
11Q09-132	12 Faucet	48"	Glycol	1363.95

WALL MOUNT DISPENSERS

Catalog No.	Faucets	Length	Air/Glycol	Each
11Q09-202	2 Faucet	15"	Air	413.95
11Q09-212	2 Faucet	15"	Glycol	461.95
11Q09-203	3 Faucet	15"	Air	435.95
11Q09-213	3 Faucet	15"	Glycol	497.95
11Q09-204	4 Faucet	15"	Air	458.95
11Q09-214	4 Faucet	15"	Glycol	541.95
11Q09-205	5 Faucet	24"	Air	530.95
11Q09-215	5 Faucet	24"	Glycol	633.95
11Q09-206	6 Faucet	24"	Air	553.95
11Q09-216	6 Faucet	24"	Glycol	677.95
11Q09-208	8 Faucet	30"	Air	723.95
11Q09-218	8 Faucet	30"	Glycol	882.95
11Q09-210	10 Faucet	36"	Air	954.95
11Q09-220	10 Faucet	36"	Glycol	1152.95
11Q09-222	12 Faucet	48"	Air	1164.95
11Q09-232	12 Faucet	48"	Glycol	1403.95

Stainless Steel Under-Bar and Wall-Mount Dispensers



304 Grade S/S Liquid Contact Dispensers

SAME UNITS AS ABOVE, BUT WITH 304 GRADE S/S FAUCETS AND SHANKS



UNDER BAR MOUNT DISPENSERS

Catalog No.	Faucets	Length	Air/Glycol	Each
11Q09-302	2 Faucet	15"	Air	525.95
11Q09-312	2 Faucet	15"	Glycol	575.95
11Q09-303	3 Faucet	15"	Air	585.95
11Q09-313	3 Faucet	15"	Glycol	647.95
11Q09-304	4 Faucet	15"	Air	652.95
11Q09-314	4 Faucet	15"	Glycol	735.95
11Q09-305	5 Faucet	24"	Air	725.95
11Q09-315	5 Faucet	24"	Glycol	824.95
11Q09-306	6 Faucet	24"	Air	783.95
11Q09-316	6 Faucet	24"	Glycol	902.95
11Q09-308	8 Faucet	30"	Air	1070.95
11Q09-318	8 Faucet	30"	Glycol	1229.95
11Q09-310	10 Faucet	36"	Air	1364.95
11Q09-320	10 Faucet	36"	Glycol	1471.95
11Q09-322	12 Faucet	48"	Air	1455.95
11Q09-332	12 Faucet	48"	Glycol	1679.95

WALL MOUNT DISPENSERS

Catalog No.	Faucets	Length	Air/Glycol	Each
11Q09-402	2 Faucet	15"	Air	485.95
11Q09-412	2 Faucet	15"	Glycol	534.95
11Q09-403	3 Faucet	15"	Air	544.95
11Q09-413	3 Faucet	15"	Glycol	606.95
11Q09-404	4 Faucet	15"	Air	604.95
11Q09-414	4 Faucet	15"	Glycol	686.95
11Q09-405	5 Faucet	24"	Air	712.95
11Q09-415	5 Faucet	24"	Glycol	785.95
11Q09-406	6 Faucet	24"	Air	743.95
11Q09-416	6 Faucet	24"	Glycol	862.95
11Q09-408	8 Faucet	30"	Air	1004.95
11Q09-418	8 Faucet	30"	Glycol	1163.95
11Q09-410	10 Faucet	36"	Air	1305.95
11Q09-420	10 Faucet	36"	Glycol	1415.95
11Q09-422	12 Faucet	48"	Air	1492.95
11Q09-432	12 Faucet	48"	Glycol	1717.95



Wall Mount "Boxed" S/S Dispenser Housings

FOR AIR OR GLYCOL SYSTEMS • HEAVY-DUTY 16 GAUGE STAINLESS STEEL CONSTRUCTION
Faucets and Shanks • Sold Separately

- 2 pc. construction: Box mounts to wall then wall mount drain attaches to box once shanks/faucets have been attached and insulated
- Drain pan measures: 8" D x 1" H x Length listed
- Box measures: 6" D x 15" H x Length listed
- Shank hole spacing: 3" on centers
- 1/2" BSP x 2" length drain tube

Catalog No.	Shank Holes	Length	Each
11F09-424	4 Holes	16" Tray	331.95
11F09-426	6 Holes	22" Tray	379.95
11F09-428	8 Holes	28" Tray	430.95
11F09-410	10 Holes	34" Tray	494.95



Under Bar Stainless Dispensers with Legs With Chrome Plated Brass Faucets and Shanks

AIR OR GLYCOL SYSTEMS AVAILABLE • HEAVY-DUTY 16 GAUGE STAINLESS STEEL CONSTRUCTION
INCLUDES: Station, faucets, shanks, legs, mounting box, mounting brackets. Air systems have two 4" O.D. S/S tubes. 6" length attached to the bottom of the box for easy connection to a 4" diameter flexible hose.

IMPORTANT

ALL LEGS ARE CUSTOM FITTED TO BAR HEIGHT

WE WILL REQUIRE THE **EXACT** MEASUREMENTS FROM THE FLOOR TO THE BOTTOM (UNDERSIDE) OF THE BAR TOP WHERE THE DISPENSER IS TO BE INSTALLED.

DROP SHIPPED FROM MFG.
LEGS ARE SHIPPED UNATTACHED FROM THE DISPENSER



Overall height: 14" • Drain depth: 6-1/4"
Faucet spacing: 3" • Leg adjustment 3"
Box: 5" H x 7" D x dispenser length



MODELS UP TO 24 FAUCETS AVAILABLE



OR



AIR COOLED DISPENSERS WITH LEGS

Catalog No.	Faucets	Length	Each
11Q09-333	14 Faucets	48" Tray	1591.95
11Q09-334	16 Faucets	48" Tray	1743.95
11Q09-335	18 Faucets	60" Tray	1995.95
11Q09-336	20 Faucets	60" Tray	2082.95
11Q09-337	24 Faucets	76" Tray	2432.95

GLYCOL COOLED DISPENSERS WITH LEGS

Catalog No.	Faucets	Length	Each
11Q09-338	14 Faucets	48" Tray	1838.95
11Q09-339	16 Faucets	48" Tray	2025.95
11Q09-340	18 Faucets	60" Tray	2312.95
11Q09-341	20 Faucets	60" Tray	2435.95
11Q09-342	24 Faucets	76" Tray	2856.95

Imported Polished Stainless Steel Columns & Towers

ALL 304 S/S FAUCETS, SHANKS AND 3/16" PRODUCT LINES • **COOLTAP** SHANK TECHNOLOGY

ALL TOWERS ARE MANUFACTURED OF HEAVY GAUGE STAINLESS STEEL AND HIGHLY POLISHED TO A MIRROR FINISH.

Shanks bolt into large aluminum blocks with copper glycol lines passing through the blocks to insure optimal cooling. Beer lines and glycol lines are bundled together in an insulated, foiled enclosure providing efficient convection cooling of beer lines. Thermo-seals are used to separate the cooling blocks from the body to insure no condensation on the tower. 3/16" product lines are 304 grade S/S with 3/16" barbed ends extending out past bottom of tower (additional restriction will need to be applied). 3/8" copper glycol lines with 3/8" barbed ends extending out past bottom of tower for easy connection. Shanks and faucets are 304 grade S/S as well.

Imported Polished Stainless Steel Columns and Towers



①

304 S/S

LIQUID CONTACT

GLY

Gefest

- 3-1/3" diameter
- 18-1/2" height



②

304 S/S

LIQUID CONTACT

GLY

Persey-Right

- 3-1/3" diameter
- 18-1/2" height



③

304 S/S

LIQUID CONTACT

GLY

Persey-Left

- 3-1/3" diameter
- 18-1/2" height

Ref. #	Catalog No.	Description	Faucets	Lbs. of Restriction	Each
1	11U07-300	Gefest	1	3 lbs.	164.00
1	11U07-301	Gefest	2	3 lbs.	208.00

Ref. #	Catalog No.	Description	Faucets	Lbs. of Restriction	Width	Each
2	11U07-310	Persey-Right	3	4 lbs.	20"	446.00
2	11U07-311	Persey-Right	4	4 lbs.	24"	538.00
3	11U07-312	Persey-Left	3	4 lbs.	20"	446.00
3	11U07-313	Persey-Left	4	4 lbs.	24"	538.00



304 S/S

LIQUID CONTACT

GLY

Terra

- 3-1/3" diameter
- 16" height



304 S/S

LIQUID CONTACT

GLY

Arcadia

- 3-1/3" diameter
- 18-1/2" height
- (*) Denotes tower has 3 upright legs
- (**) Denotes tower has vinyl product lines

UNLIMITED FAUCETS AVAILABLE WITH ADDITIONAL SUPPORT LEGS

Catalog No.	Description	Faucets	Lbs. of Restriction	Width	Each
11U07-320	Terra	4	3 lbs.	17-1/2"	556.00
11U07-321	Terra	5	3 lbs.	26"	639.00
11U07-322	Terra	6	3 lbs.	25"	698.00
11U07-323	Terra	8	3 lbs.	31-3/4"	793.00

Catalog No.	Description	Faucets	Lbs. of Restriction	Width	Each
11U07-330	Arcadia	8	4-1/2 lbs.	35-1/2"	1040.00
11U07-331	Arcadia	10	4 lbs.	41-5/8"	1212.00
11U07-332	Arcadia	12	4-1/2 lbs.	47-5/8"	1325.00
*11U07-333	Arcadia	14	4-1/2 lbs.	60-3/4"	1550.00
*11U07-334	Arcadia	**16	15 lbs.	67"	2257.00



304 S/S

LIQUID CONTACT

GLY

Milano

The one and two faucet towers have a 1-1/4" diameter x 6" brass mounting sleeve & nut. The three faucet has a 1-3/4" diameter x 6" brass mounting sleeve & nut.



Italian Chrome Plated Brass Towers

WITH AMERICAN FAUCETS AND SHANKS (KNOBS SOLD SEPARATELY)

15" HEIGHT

ALL TOWERS ARE GLYCOL READY

Towers have 3/16" stainless steel beer lines and 3/8" glycol lines. Lines have been taped and insulated for efficient cooling of beer lines.

Catalog No.	Description	Faucets	Lbs. of Restriction	Each
11U07-340	Milano	1	3.6 lbs.	245.00
11U07-341	Milano	2	3.6 lbs.	289.00
11U07-342	Milano	3	3.6 lbs.	384.00



Imported Polished Stainless Steel Glycol Towers

ALL 304 S/S LIQUID CONTACT (FAUCETS, SHANKS AND PRODUCT LINES) • COOLTAP SHANK TECHNOLOGY

Metro

4" diameter pedestals • 3" faucet centers
 12" faucet clearance • width on centers
 3/16" barbed 304 S/S product lines
 3/8" barbed copper glycol lines

Catalog No.	Faucets	Lbs. of Restriction	Width	Each
11U07-350	8	4-1/2 lbs.	31-35/64"	1252.00
11U07-351	10	4 lbs.	37-29/64"	1430.00
11U07-352	12	4 lbs.	43-23/64"	1619.00
11U07-353	14	4-1/2 lbs.	49-1/4"	1844.00
11U07-354	16	4-1/2 lbs.	57-3/8"	1957.00



Norma

4" diameter pedestals • 3" faucet centers
 12" faucet clearance • width on centers
 3/16" barbed 304 S/S product lines
 3/8" barbed copper glycol lines

Catalog No.	Faucets	Lbs. of Restriction	Width	Each
11U07-360	8	4-1/2 lbs.	32-21/64"	1640.00
11U07-361	10	4 lbs.	38-15/64"	1818.00
11U07-362	12	4 lbs.	44-9/64"	2008.00
11U07-363	14	4-1/2 lbs.	52-1/8"	2150.00
11U07-364	16	4-1/2 lbs.	53-1/2"	2339.00



Atlas

4" diameter pedestals • 3" faucet centers
 12" faucet clearance • width on centers
 3/16" barbed 304 S/S product lines
 3/8" barbed copper glycol lines

Catalog No.	Faucets	Lbs. of Restrictions	Width	Each
11U07-370	8	4-1/2 lbs.	38-15/32"	1417.00
11U07-371	10	3-1/2 lbs.	44-3/8"	1606.00
11U07-372	12	4 lbs.	50-9/32"	1784.00
11U07-373	14	4-1/2 lbs.	56-3/16"	2056.00



Imported Polished Stainless Steel Towers

High Quality Imported Ceramic Towers

OVERALL HEIGHT: 23" • OVERALL WIDTH: 7" • BASE DIAMETER: 5-1/2" • HEIGHT TO FAUCET: 13-1/2"
 INCLUDES: STANDARD FAUCET (KNOB SOLD SEPARATELY) AND MOUNTING HARDWARE

ALL CERAMIC TOWERS AIR COOLED. GLYCOL COOLED TOWERS ARE SPECIAL ORDER

Red



CHROME TRIM		
Catalog No.	Faucets	Each
11U07-501	1	295.00
11U07-502	2	350.00
11U07-503	3	395.00
GOLD TRIM		
11U07-511	1	295.00
11U07-512	2	350.00
11U07-513	3	395.00

White

CHROME TRIM		
Catalog No.	Faucets	Each
11U07-401	1	295.00
11U07-402	2	350.00
11U07-403	3	395.00
GOLD TRIM		
11U07-411	1	295.00
11U07-412	2	350.00
11U07-413	3	395.00



Black

CHROME TRIM		
Catalog No.	Faucets	Each
11U07-601	1	295.00
11U07-602	2	350.00
11U07-603	3	395.00
GOLD TRIM		
11U07-611	1	295.00
11U07-612	2	350.00
11U07-613	3	395.00



High Quality Imported Ceramic Towers



Air Cooled Ceramic Towers

AVAILABLE IN CHROME OR GOLD PLATED TRIMS – PLEASE SPECIFY CHOICE WHEN ORDERING

All towers sold less knobs and hoses • Dimensions: 22" height x 7 1/2" diameter x 12 3/4" faucet clearance • 3" diameter threaded PVC mounting sleeve



BLACK MARBLE



COBALT BLUE



ANTIQUE GREEN



PEARL WHITE



BLACK MARBLE

Catalog No.	Faucets	Color/Trim	Each
11A03-301	1-Faucet	Specify when ordering	913.00
11A03-302	2-Faucet	Specify when ordering	952.00
11A03-303	3-Faucet	Specify when ordering	1011.00
11A03-304	4-Faucet	Specify when ordering	1070.00

Catalog No.	Faucets	Color/Trim	Each
11A03-305	5-Faucet	Specify when ordering	1149.00
11A03-306	6-Faucet	Specify when ordering	1346.00
–	–	–	–
11A03-308	8-Faucet	Specify when ordering	1477.00



PVC Mounting Sleeve

All ceramic towers include a 3" diameter threaded sleeve and nut for easy installation.

Drain Trays with Stainless Grid

FITS CERAMIC AND MUSHROOM TOWERS

1/2" NPT drain, 20" L x 10" W x 1" D

11A03-213 (Brass Tray) \$313.95

11A03-214 (S/S Tray) \$309.95

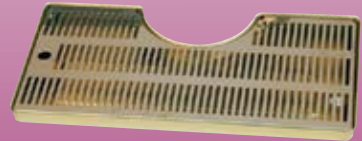

Brass Drain Tubes

Catalog No.	Description	25+	10+	Each
11B03-101	1/2" BSP x 2" Length	2.75	3.00	3.50
11B03-100	1/2" BSP x 4" Length	2.95	3.50	3.95
11K03-105	5/8"-18" x 3-1/2" Length	3.95	4.50	4.95

Catalog No.	Length	50+	25+	Each
11K03-100	Silicone Drain Seal for 1/2" BSP	0.30	0.35	0.50



1/2" BSP x 2" Length



1/2" BSP x 4" Length



1/2" BSP Silicone Seal



5/8"-18 x 3-1/2" Length

PVD Brass Drains with Plastic "Egg Crate" Grate

1/2" BSP THREADED DRAIN TUBE • 3/4" DRAIN DEPTH

COUNTER MOUNT



FLUSH MOUNT



Catalog No.	Length	Width	4+	2+	Each
11B03-103	14-5/8"	5-3/8"	97.95	101.95	106.95
11B03-102	24"	5-3/8"	125.95	130.95	136.95
*11A03-120	36"	5-3/8"	–	–	275.95

* Has a PVD Tarnish-Free brass louvered grate.

Catalog No.	Length	Width	4+	2+	Each
11A03-121	8"	5-3/8"	104.95	108.95	113.95
11A03-122	15"	5-3/8"	112.95	117.95	122.95
11A03-123	24"	5-3/8"	152.95	158.95	165.95
11A03-124	36"	5-3/8"	172.95	179.95	187.95



Surface Mount 304 S/S Drains (5-1/8" Wide)

HEAVY-DUTY SHEET METAL • 1" DRAIN DEPTH • 2" LENGTH DRAIN TUBE



Catalog No.	Length	4+	2+	Each
11F09-310	6"	37.95	39.95	41.95
11F09-311	12"	52.95	55.95	58.95
11F09-312	16"	72.95	76.95	80.95
11F09-314	24"	91.95	96.95	102.95

Catalog No.	Length	4+	2+	Each
11F09-333	30"	103.95	109.95	115.95
11F09-334	36"	118.95	125.95	132.95
* 11F09-335	48"	137.95	145.95	153.95

* NOTE: This item has two drain tubes – one on each end

Stainless Steel Drains (for Columns and Towers)



Surface Mount 304 S/S Drains (8" Wide)

HEAVY-DUTY SHEET METAL • 1" DRAIN DEPTH • 2" LENGTH DRAIN TUBE

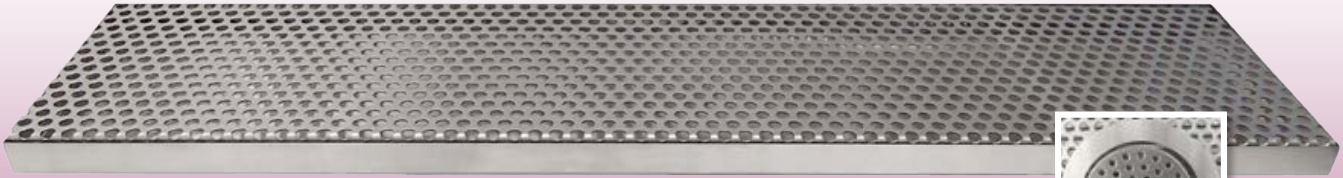

NOTE: Add a rinsers to the 8" wide models for **\$95.00** Call your sales rep. for details.

Catalog No.	Length	4+	2+	Each
11F09-411	12"	86.95	91.95	96.95
11F09-412	16"	97.95	103.95	109.95
11F09-414	24"	123.95	130.95	137.95
11F09-433	30"	144.95	151.95	160.95

Catalog No.	Length	4+	2+	Each
11F09-434	36"	167.95	176.95	186.95
* 11F09-435	48"	212.95	223.95	236.95

* NOTE: This item has two drain tubes – one on each end



Flush Mount 304 S/S Drains (5-1/8" Wide Grate)

HEAVY-DUTY SHEET METAL • 1" DRAIN DEPTH • 2" LENGTH DRAIN TUBE

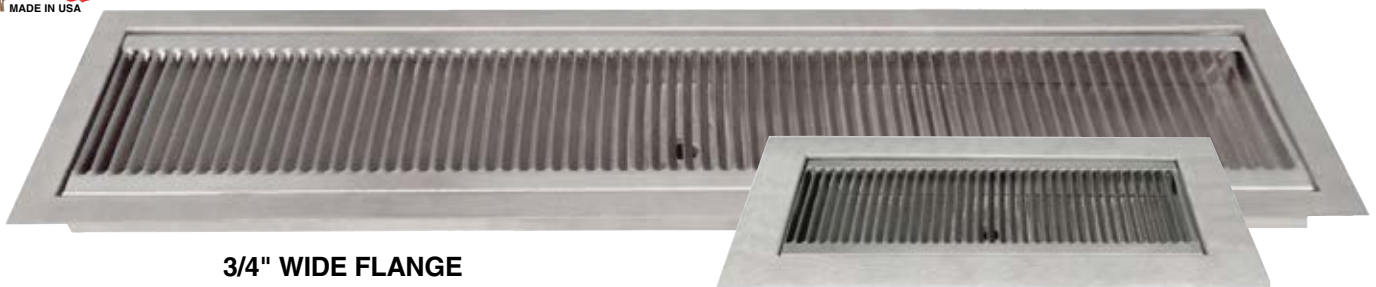

3/4" WIDE FLANGE

1-1/2" WIDE FLANGE

Catalog No.	CUT OUT SIZE		3/4" WIDE FLANGE		
	Length	Width	4+	2+	Each
11F09-208	12"	5-1/4"	57.95	60.95	63.95
11F09-231	16"	5-1/4"	82.95	87.95	92.95
11F09-209	24"	5-1/4"	106.95	112.95	118.95

Catalog No.	CUT OUT SIZE		1-1/2" WIDE FLANGE		
	Length	Width	4+	2+	Each
11F09-108	12"	5-1/4"	57.95	60.95	63.95
11F09-131	16"	5-1/4"	83.95	87.95	91.95
11F09-109	24"	5-1/4"	106.95	112.95	118.95





Wall Mount 304 S/S Drains with Back Splash

HEAVY-DUTY SHEET METAL • 1" DRAIN DEPTH • 2" LENGTH DRAIN TUBE



6" LENGTH

11R09-118

4+ \$23.95

2+ \$24.95

EA. \$25.95

4-1/2" WIDE

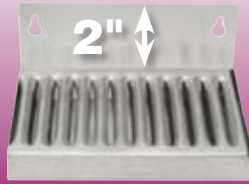

12" LENGTH

11F09-107

4+ \$54.95

2+ \$57.95

EA. \$61.95

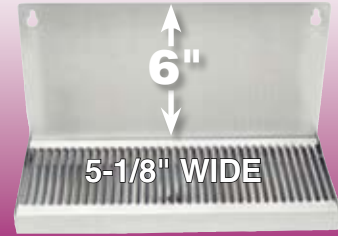

Wall Mount 304 S/S Drains with Shank Cutouts

HEAVY-DUTY SHEET METAL • 1" DRAIN DEPTH • 2" LENGTH DRAIN TUBE



NOTE:

Add a rinser to the 8" wide models for **\$95.00.**

Call your sales representative for details.

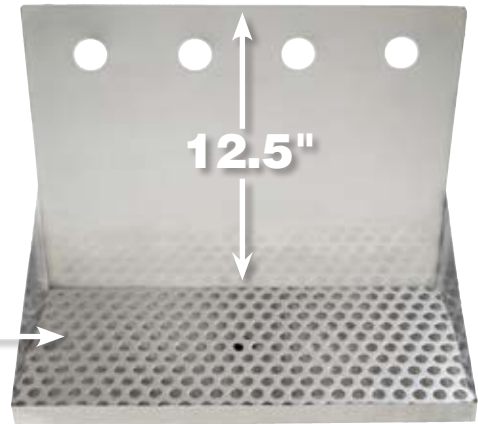

5-1/8" WIDE WITH LOUVERED GRATE					
Catalog No.	Shank Holes	Length	4+	2+	Each
11F09-119	1	6"	42.95	44.95	47.95
11F09-120	2	12"	56.95	60.95	63.95
11F09-130	3	12"	59.95	62.95	66.95
11F09-124	4	16"	129.95	136.95	144.95
11F09-125	5	19"	166.95	175.95	185.95
11F09-126	6	22"	208.95	216.95	225.95

8" WIDE WITH PERFORATED GRATE					
Catalog No.	Shank Holes	Length	4+	2+	Each
11F09-230	3	13"	95.95	100.95	106.95
11F09-224	4	16"	182.95	192.95	203.95
11F09-225	5	19"	203.95	211.95	220.95
11F09-226	6	22"	231.95	240.95	250.95
11F09-228	8	28"	273.95	284.95	296.95
11F09-210	10	34"	320.95	333.95	346.95
11F09-242	12	40"	387.95	402.95	418.95

CUSTOM DRAINS AVAILABLE UPON REQUEST – CALL YOUR SALES REPRESENTATIVE FOR DETAILS



Drip Trays (Without a Drain Hole) 304 S/S

HEAVY-DUTY SHEET METAL • 1" DRAIN DEPTH



5-1/8" WIDE



WITH REMOVABLE MOUNTING TABS

4-1/2" WIDE



SURFACE MOUNT				
Catalog No.	Length	4+	2+	Each
11F09-006	6"	35.95	37.95	39.95
11F09-011	12-1/8"	52.95	55.95	58.95

WALL MOUNT					
Catalog No.	Length	Back Height	4+	2+	Each
11R09-116	4"	1"	18.95	19.95	20.95
11R09-117	6"	2"	21.95	22.95	23.95
11F09-007	12"	6"	57.95	60.95	63.95



Wall Mount 304 S/S Growler Filling Stations

8" WIDE • 1" DRAIN DEPTH • 2" LENGTH DRAIN TUBE

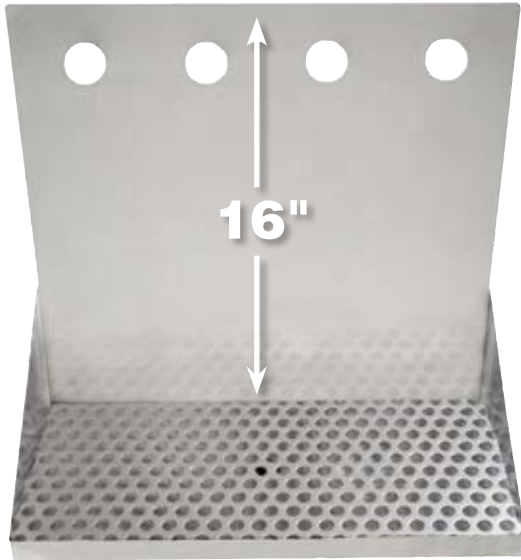

PERFECT FOR FILLING GROWLERS AND TALL GLASSES



ADD A RINSER TO THIS DRAIN TYPE FOR **\$95.00** CALL FOR DETAILS.

Catalog No.	Faucets	Length	4+	2+	Each
11F09-260	3	13"	105.95	110.95	115.95
11F09-261	4	16"	199.95	209.95	216.95
11F09-262	5	19"	216.95	225.95	231.95
11F09-263	6	22"	245.95	255.95	262.95
11F09-264	8	28"	289.95	301.95	309.95
11F09-265	10	34"	348.95	361.95	371.95
11F09-266	12	40"	409.95	425.95	442.95

Growler Filling Stations and Longer Drains



Wall Mount Drains – Variable Amount of Shank Holes

14-1/2" BACK SPLASH • 6" WIDE • 3/4" DRAIN DEPTH • 4" LENGTH DRAIN TUBE



Order desired drain length. Let your customer service representative know how many shank holes you require and their placement by supplying faucet center spacing.



UP TO 76" LENGTH

SHIPS DIRECT FROM THE MANUFACTURER

Catalog No.	Length	No. of Holes	4+	2+	Each
11F09-153	48"	Up to 15 Holes	316.95	325.95	333.95
11F09-154	60"	Up to 20 Holes	423.95	434.95	445.95

Catalog No.	Length	No. of Holes	4+	2+	Each
-	-	-	-	-	-
11F09-156	76"	Up to 25 Holes	532.95	546.95	560.95

Counter Mount Drains – Longer Length

3/4" DRAIN DEPTH • 4" LENGTH DRAIN TUBE



UP TO **76"** LONG

5-1/4" OR 8" WIDE

5-1/4" WIDE					
Catalog No.	Length	4+	2+	Each	
11F09-157	60"	220.95	224.95	232.95	

8" WIDE					
Catalog No.	Length	4+	2+	Each	
11F09-158	62"	262.95	269.95	276.95	
11F09-159	76"	337.95	345.95	355.95	



Stainless Steel Glass Rinsers

IMPROVES POURING OF BEER • ENCOURAGES HEAD RETENTION • REMOVES IMPURITIES • COOLS GLASS



DIMENSIONS:
6-3/8" square
1" Depth

DRAIN TUBE:
3-1/2" L x 1/2" O.D.
WATER SUPPLY:
3-1/2" L x 3/8" Barb

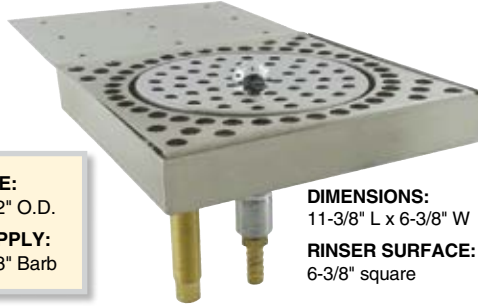

DIMENSIONS:
11-3/8" L x 6-3/8" W
RINSER SURFACE:
6-3/8" square



DIMENSIONS:
4-5/8" Diameter
3-1/2" Length
3/8" Barb

11K09-110 **COUNTER MOUNT**
Ea. **\$42.95**

11K09-100 **UNDER COUNTER MOUNT**
Ea. **\$38.95**

12K09-110 **RINSER ONLY**
Ea. **\$26.95**

Additional price breaks available on most items. Login to your website account or contact your sales representative for pricing.

Stainless Steel Rinsing Tubs

IMPROVES POURING OF BEER • ENCOURAGES HEAD RETENTION • REMOVES IMPURITIES • COOLS GLASS



11K09-102 **FLUSH MOUNT**
Ea. **\$63.95**

Replacement Rinsing



11K09-010
\$35.95

INNER SIZE: 6" x 5-1/2" x 2-1/2"
WATER SUPPLY: 3/8" OD Push-in
DRAIN TUBE: 1/2" Barb



11K09-103 **COUNTER-TOP**
Ea. **\$77.95**

SUCTION CUP MOUNTING

Stainless Steel Rinsing Drains – Counter-Top Mounting

IMPROVES POURING OF BEER • ENCOURAGES HEAD RETENTION • REMOVES IMPURITIES • COOLS GLASS

BECAUSE PRESENTATION IS EVERYTHING!

RINSER ARMS HAVE CLEAR TUBING COVER
TO CUSHION GLASS DURING RINSE



RINSER STEM IS
1-3/4" LENGTH x 1/2" BSP
8" Wide x 1 1/4" Height



11F09-150 **30" Length**
4+ **\$203.95**
2+ **\$209.95** Ea. **\$214.95**

11F09-151 **36" Length**
4+ **\$224.95**
2+ **\$230.95** Ea. **\$236.95**

11F09-152 **45" Length**
4+ **\$244.95**
2+ **\$251.95** Ea. **\$257.95**

Counter Mount Stainless Steel Rinser Drains

HEAVY GAUGE STAINLESS STEEL • QUALITY CONSTRUCTION

4 DIFFERENT LENGTHS
x 7" D x 3/4" H

WATER INLET
3/8" PUSH-IN AND
5' POLY TUBING
INCLUDED



Catalog No.	Length	4+	2+	Each
11K09-024	24"	58.95	61.95	63.95
11K09-030	30"	77.95	81.95	85.95

Catalog No.	Length	4+	2+	Each
11K09-036	36"	80.95	84.95	88.95
11K09-045	45"	93.95	97.95	101.95

"Counter Mount" Stainless Steel Drains

HEAVY GAUGE STAINLESS STEEL • QUALITY CONSTRUCTION

Catalog No.	Length	10+	5+	Each
11K09-124	12"	17.95	18.95	19.95
11K09-125	16"	19.95	20.95	21.95
11K09-126	20"	22.95	23.95	24.95
11K09-127	24"	20.95	21.95	23.95
11K09-128	30"	33.95	35.95	37.95
11K09-129	36"	32.95	34.95	36.95

6 DIFFERENT LENGTHS x 5" D x 3/4" H



Additional price breaks available on most items. Login to your website account or contact your sales representative for pricing.

Flush Mount S/S Drain

HEAVY GAUGE STAINLESS STEEL • QUALITY CONSTRUCTION

13" L x 6" D x 3/4" H (Cutout: 12-1/4" x 5-1/4")

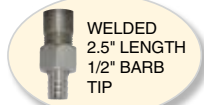

11K09-200 Drain Tray

10+ **\$15.95** 5+ \$16.95 Ea. \$17.95

Wall Mount S/S Drain

HEAVY GAUGE STAINLESS STEEL • QUALITY CONSTRUCTION

6" L x 4-1/2" D x 3/4" H (2" back-splash)



11K09-203 Drain Tray

10+ **\$10.95** 5+ \$11.95 Ea. \$12.95

Counter Mount S/S Drain

HEAVY GAUGE STAINLESS STEEL • QUALITY CONSTRUCTION



FITS 3" DIAMETER COLUMNS



12" L x 7" D x 3/4" H

4" DIAMETER AVAILABLE 11K09-160

11K09-150 Drip Tray (no Drain Tube)

10+ **\$27.95** 5+ \$29.95 Ea. \$31.95

11K09-130 Drain Tray (with Drain Tube)

10+ **\$32.95** 5+ \$34.95 Ea. \$35.95

"Wall Mount" Stainless Steel Drip Trays

HEAVY GAUGE STAINLESS STEEL • QUALITY CONSTRUCTION

5 DIFFERENT LENGTHS x 3/4" H (2" backsplash)

Catalog No.	Length	Depth	10+	5+	Each
* 11K09-201	4.5"	4"	6.95	7.50	7.95
11K09-202	6"	4"	7.95	8.50	8.95
11K09-119	10"	6"	13.50	13.95	14.95
11K09-120	12"	6"	14.95	15.95	16.95
11K09-121	14"	6"	19.95	20.95	21.95

* NOTE: only has a 1" tall backsplash

NO DRAIN TUBE



"Counter Mount" Stainless Steel Drip Trays

HEAVY GAUGE STAINLESS STEEL • QUALITY CONSTRUCTION



6" L x 5" D x 3/4" H
11K09-122 Drip Tray

10+ **\$7.50** 5+ \$7.95 Ea. \$8.95

NO DRAIN TUBE



12" L x 5" D x 3/4" H
11K09-123 Drip Tray

10+ **\$12.95** 5+ \$13.50 Ea. \$13.95

Additional price breaks available on most items. Login to your website account or contact your sales representative for pricing.

Replacement Rinsers for Rinser Drains

4.5" DIAMETER 6 POST

Rinser arms are a polyethylene to cushion glass and prevent damage

- Heavy duty construction
- Chrome plated finish
- Fits 3/4" - 1" deep pans
- Shank is 1-3/4" length
- Shank is 1/2"-14 BSP



Available in S/S
Call for price!

11K09-010 Rinser Only
6+ **\$32.95** 3+ \$33.95 Ea. \$35.95

4.5" DIAMETER 4 POST

Rinser arms are covered in clear PVC to cushion glass and prevent damage

- All metal heavy duty construction
- Chrome plated finish
- Fits 1-1/4" deep pans
- Shank is 2" length
- Shank is 1/2"-14 BSP



11F09-002 Rinser Only
6+ **\$49.95** 3+ \$51.95 Ea. \$52.95

Cooling Blocks for Glycol Towers

2 PC SPLIT RECTANGULAR SET

- Channeled for 3/8" glycol lines
- Solid aluminum
- Slides onto standard shanks

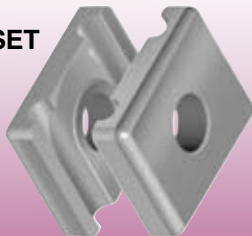

11A03-222 10+ **\$15.95**
5+ \$16.95 Ea. \$17.95

1 PC THREADED CIRCULAR SET

- Channeled for 3/8" glycol lines
- Solid aluminum
- Threads onto standard shanks



11U07-150 10+ **\$8.50**
5+ \$9.00 Ea. \$9.50

2 PC SPLIT CIRCULAR SET

- Channeled for 3/8" glycol lines
- Solid aluminum
- Slides onto standard shanks



11C03-100 10+ **\$5.95**
5+ \$6.50 Ea. \$6.95

Chrome Plated Brass Shanks



5/8" BSP
BEER THREAD



1/4" BORE			
Catalog No.	24+	12+	Each
12K03-102	4.75	4.95	5.95
12K03-103	5.75	5.95	6.50
12K03-104	7.95	8.25	8.50
12K03-105	8.25	8.50	8.95
12K03-106	10.25	10.50	10.95
12K03-108	12.50	12.95	13.50
12K03-110	18.95	19.95	20.95
12K03-112	21.95	22.50	23.95

SIZE	
Length	Max. Wall Thickness
2-1/8"	1/2"
3-1/8"	1-1/2"
4-1/8"	2-1/2"
5-1/8"	3-1/2"
6-1/8"	4-1/2"
8-1/8"	6-1/2"
10-1/8"	8-1/2"
12-1/8"	10-1/2"

3/16" BORE			
Catalog No.	24+	12+	Each
12K03-120	4.75	4.95	5.95
12K03-113	5.75	5.95	6.50
12K03-114	7.95	8.25	8.50
12K03-115	7.50	7.95	8.95
12K03-116	7.50	7.95	10.95
-	-	-	-
12K03-117	18.95	19.95	20.95
12K03-118	21.95	22.95	23.95

Chrome Plated Brass Shanks (Barbed End)



5/8" BSP
BEER THREAD



1/4" BORE			
Catalog No.	24+	12+	Each
12K03-302	5.50	5.75	5.95
12K03-303	6.50	6.95	7.95
12K03-304	7.50	7.95	8.95
12K03-305	8.50	8.95	9.95

SIZE	
Length	Max. Wall Thickness
2-3/4"	1-1/8"
3-1/2"	1-7/8"
4-1/2"	2-7/8"
5-1/2"	3-7/8"

3/16" BORE			
Catalog No.	24+	12+	Each
-	-	-	-
12K03-313	7.25	7.50	7.95
12K03-314	8.50	8.95	9.50
12K03-315	8.95	9.50	9.95

Additional price breaks available on most items. Login to your website account or contact your sales representative for pricing.

304 Grade Stainless Steel Shank



5/8" BSP
BEER THREAD



1/4" BORE					
Catalog No.	Length	Max. Wall Thickness	24+	12+	Each
12K07-102	2"	3/8"	4.50	4.75	4.95
12K07-103	3-1/8"	1-1/2"	9.95	10.50	10.95
12K07-104	4-1/8"	2-1/2"	9.25	9.50	9.95
12K07-105	5-1/8"	3-1/2"	8.95	9.50	9.95
12K07-106	6-1/8"	4-1/2"	11.50	11.95	12.50
12K07-108	8-1/8"	6-1/2"	16.95	17.50	17.95
12K07-109	10-1/8"	8-1/2"	19.95	20.95	21.95

Insta-Balance FLOW RESTRICTORS

Fits into shank behind the faucet



Catalog No.	Bore Size	Lbs. of Restriction	4+	Each
12B03-235	1/4"	1-4	12.95	13.50
12B03-236	1/4"	4-8	12.95	13.50
12B03-237	1/4"	8-12	12.95	13.50
12B03-238	1/4"	12+	12.95	13.50
12B03-239	3/16"	12+	12.95	13.50

24" Chrome Plated Brass Wall Shank

FOR USE ON WALLS UP TO 24" THICK • 3/16" BORE x 24" LENGTH S/S TUBE



5/8" BSP
BEER THREAD

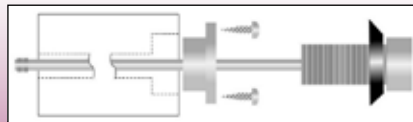

- 1-Drill 3/8" hole through wall
- 2-Drill 1-3/8" recess hole
- 3-Install flange with screws
- 4-Screw in shank until tight

Locking Flange



5/8" BSP
BEER THREAD

PREVENTS SHANK ROTATION

Catalog No.	Description	25+	10+	Each
12K03-400	24" Wall Shank Assembly	13.95	14.95	15.95
12K03-402	Locking Flange only	2.07	2.20	2.95



Thread-In Shanks for Perlick Towers



KROME DISPENSE BRAND

Catalog No.	Description	24+	12+	Each
12K09-170	1-5/8" L Thread-in Shank	4.50	4.75	5.25

PERLICK BRAND

Catalog No.	Description	24+	12+	Each
12G09-170	1-5/8" L Thread-in Shank	17.95	18.95	19.95
12G09-169	2-3/16" L Thread-in Shank	19.95	20.95	21.95
12G09-174	Replacement O-ring	0.20	0.22	0.25



Chrome Plated Brass Shanks

1/4" BORE			
Catalog No.	24+	12+	Each
12B03-111	8.50	8.95	9.50
12B03-112	9.95	10.50	10.95
12B03-113	12.50	12.95	13.95
12B03-114	13.95	14.95	15.50
12B03-115	15.50	16.50	16.95
12B03-116	18.50	19.50	19.95
12B03-117	22.95	23.95	24.95
12B03-197	27.50	28.95	29.95
12B03-198	30.95	32.50	33.95
12B03-199	37.50	39.50	41.50
12B03-200	42.95	45.50	47.50

SIZE	
Length	Max. Wall Thickness
1-3/4"	3/8"
3-1/8"	1-3/8"
4-1/8"	2-1/2"
5-1/8"	3-1/2"
6-1/8"	4-3/8"
8-1/8"	6-3/8"
10"	8-3/8"
12"	10-3/8"
14"	12-3/8"
16"	14-3/8"
18"	16-3/8"

3/16" BORE			
Catalog No.	24+	12+	Each
-	-	-	-
12K09-102	9.95	10.50	10.95
12K09-103	12.50	13.50	13.95
12K09-104	13.95	14.95	15.50
12K09-105	15.50	16.50	16.95
12K09-106	18.50	19.50	19.95
12K09-107	23.50	24.95	25.95
-	-	-	-
-	-	-	-
-	-	-	-
-	-	-	-
-	-	-	-



5/8" BSP
BEER THREAD



Chrome Plated Brass Shanks (Barbed End)

1/4" BORE (1/4" BARB)			
Catalog No.	24+	12+	Each
12A03-130	12.50	12.95	13.50
-	-	-	-
12A03-131	13.95	14.95	15.50
-	-	-	-
12A03-132	14.50	15.50	15.95
12A03-134	16.95	17.95	18.95

SIZE	
Length	Max. Wall Thickness
2-7/8"	1-5/8"
3"	1-3/4"
3-1/2"	2-3/8"
4-1/8"	3"
4-1/2"	3-3/8"
5-3/8"	4-1/8"

3/16" BORE (3/16" BARB)			
Catalog No.	24+	12+	Each
12A03-135	12.50	12.95	13.50
*12A03-118	16.95	17.95	18.50
12A03-136	13.95	14.95	15.50
*12A03-133	17.95	18.95	19.50
12A03-137	14.50	15.50	15.95
12A03-138	16.95	17.95	18.50

* Has a 90° barbed end



5/8" BSP
BEER THREAD



304 Grade Stainless Steel Shanks

Insta-Balance FLOW RESTRICTORS

Fits into shank
behind the faucet



Catalog No.	Bore Size	Lbs. of Restriction	4+	Each
12B03-235	1/4"	1-4	12.95	13.50
12B03-236	1/4"	4-8	12.95	13.50
12B03-237	1/4"	8-12	12.95	13.50
12B03-238	1/4"	12+	12.95	13.50
12B03-239	3/16"	12+	12.95	13.50

1/4" BORE					
Catalog No.	Length	Max. Wall Thickness	24+	12+	Each
12S07-101	1-3/4"	3/8"	15.95	16.50	17.50
12S07-102	3"	1-3/8"	18.95	19.50	20.50
12S07-103	4-1/8"	2-3/8"	21.50	22.50	23.50
12S07-104	6"	4-3/8"	26.50	27.95	28.95
12S07-109	8"	6-3/8"	41.95	44.50	46.50
12S07-110	10"	8-3/8"	56.50	59.50	61.95
12S07-118	12"	10-3/8"	70.95	74.95	77.95



5/8" BSP
BEER THREAD



Universal Shank Replacement Parts

Additional price breaks available on most items. Contact your sales rep. for pricing.

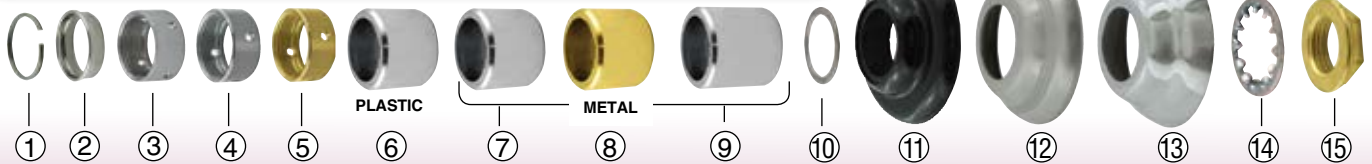

Ref. #	Catalog No.	Description	Each
1	12B03-178	Snap Ring	0.26
2	12B03-179	Sleeve	0.98
3	12K03-181	Coupling Ring (Chrome)	1.50
4	12B03-181	Coupling Ring (Chrome)	2.15
5	12B03-180	Coupling Ring (PVD Gold)	2.58

Ref. #	Catalog No.	Description	Each
6	12A03-167	1" Spacer (Chrome)	4.75
7	12K03-167	1" Spacer (Chrome)	2.50
8	12K03-168	1" Spacer (PVD Gold)	3.95
9	12C03-302	1-3/4" Spacer (Chrome)	11.95
10	12B03-182	Flange Washer	0.95

Ref. #	Catalog No.	Description	Each
11	12B03-184	Flange (Black Plastic)	1.41
12	12B03-183	Flange (Brushed S/S)	2.58
13	12K03-180	Flange (Polished S/S)	1.75
14	12A03-168	Lock Washer (Dual Shank)	0.95
15	12B03-185	Lock Nut	1.00

CHROME PLATED (FITS 3/16" OR 1/4")			
Catalog No.	6+	3+	Each
12A03-162	80.95	83.95	87.95
12A03-164	83.95	87.95	91.95
12A03-166	87.95	92.95	96.95
12A03-169	109.95	114.95	119.95
12A03-170	113.95	117.95	123.95
12A03-171	118.95	123.95	129.95

SIZE	
Length	Max. Wall Thickness
2"	1-1/2"
4"	3-1/2"
6"	5-1/2"
8"	7-1/2"
10"	9-1/2"
12"	11-1/2"

POLISHED BRASS (FITS 3/16" OR 1/4")			
Catalog No.	6+	3+	Each
12A03-175	-	-	82.95
12A03-176	-	-	87.95
12A03-177	-	-	9.95
12A03-178	-	-	114.95
12A03-179	-	-	117.95
12A03-180	-	-	9.95

Dual Shank Assemblies



5/8" BSP
BEER THREAD





Krome Dispense Standard Faucets

HIGH QUALITY • WIDE RANGE OF PRODUCTS • AFFORDABLY PRICED

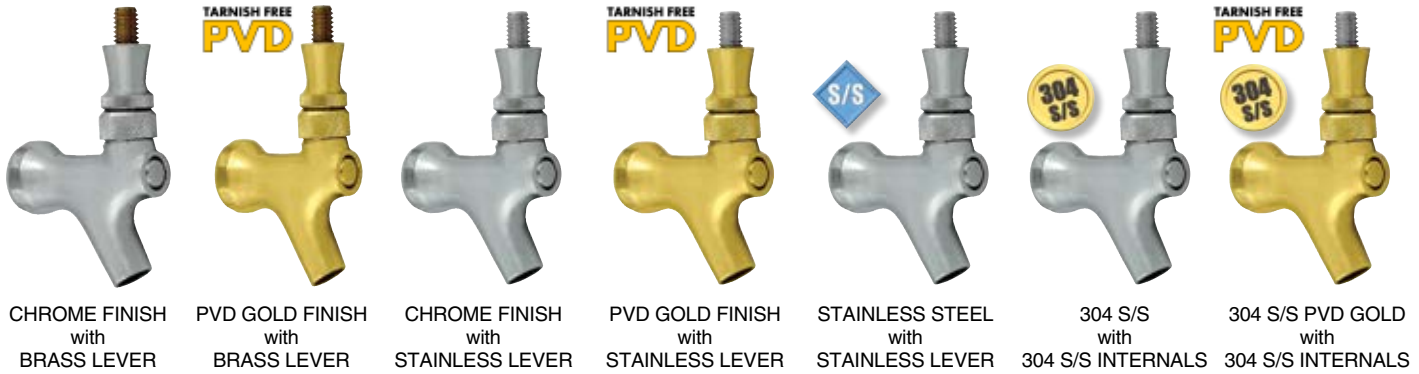

Catalog No.	Body	Lever	24+	12+	Each
12K02-100	Chrome	Brass	7.95	8.50	8.95
12K02-101	PVD Gold	Brass	11.95	12.50	12.95
12K02-102	Chrome	Stainless	8.95	9.50	9.95
12K02-103	PVD Gold	Stainless	13.50	13.95	14.95

Catalog No.	Body	Lever	24+	12+	Each
12K02-110	Stainless	Stainless	13.50	13.95	14.95
12K02-104	304 S/S	304S/S	18.50	18.95	19.95
12K02-113	304 PVD	304 S/S	21.95	22.95	24.95

Additional price breaks available on most items. Login to your website account or contact your sales representative for pricing.

ABECO Standard Faucets

HIGH QUALITY FAUCETS • WIDE RANGE OF PRODUCTS • NSF LISTED

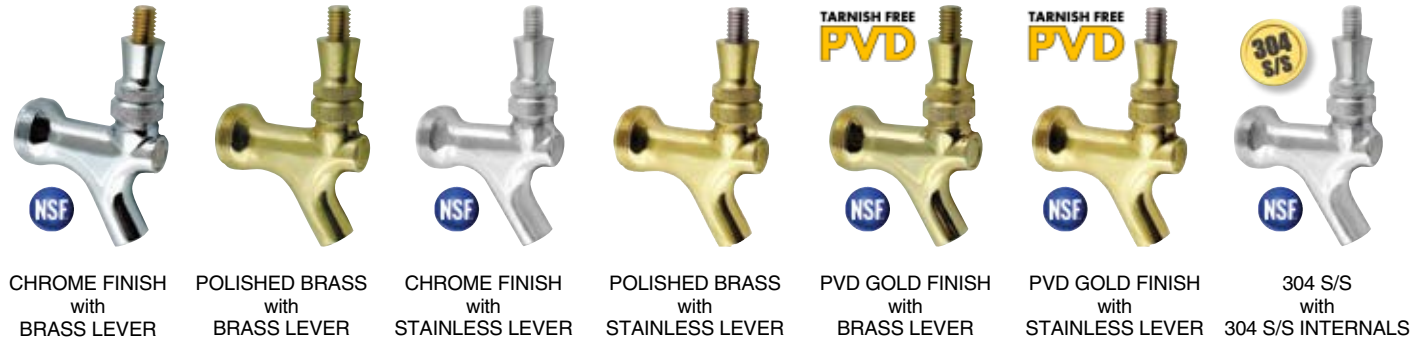

Catalog No.	Body	Lever	24+	12+	Each
12B03-118	Chrome	Brass	12.50	12.95	13.95
12B03-119	Brass	Brass	13.95	14.95	15.95
12A03-148	Chrome	Stainless	13.95	14.95	15.95
12A03-149	Brass	Stainless	15.95	16.95	17.95

Catalog No.	Body	Lever	24+	12+	Each
12A03-172	PVD Gold	Brass	24.95	27.95	29.95
12A03-173	PVD Gold	Stainless	26.95	28.95	30.95
12S07-100	304 S/S	304 S/S	31.95	33.95	36.95

Taprite Standard Faucets

HIGH QUALITY • A PREFERRED SUPPLIER



Catalog No.	Body	Lever	24+	12+	Each
12S07-116	Chrome	Brass	12.95	13.50	13.95
12S07-117	PVD Gold	Brass	15.95	16.95	17.95

Perlick Standard Faucets

HIGH QUALITY • INDUSTRY STANDARD



Catalog No.	Body	Lever	24+	12+	Each
12G09-123	Chrome	Brass	25.95	26.95	29.95
12G09-124	PVD Gold	Brass	37.95	39.95	43.95

Standard Style Beer Faucets (All Brands)





Perlick FORWARD SEALING Faucets



REVOLUTIONARY BALL & FLOATING FRONT SEAL DESIGN PREVENTS BEER FROM BEING EXPOSED TO AIR



304 S/S FLOW CONTROL ONLY **304 S/S** FLOW CONTROL & CREAMER FUNCTION **304 S/S** STANDARD FUNCTION & CREAMER FUNCTION **CHROME PLATED** STANDARD FUNCTION ONLY **304 S/S** STANDARD FUNCTION ONLY **304 S/S PVD** STANDARD FUNCTION ONLY

Catalog No.	Description	12+	6+	Each
12G09-301	Flow Control only	49.95	53.95	57.95
12G09-294	Flow Control & Creamer	59.95	63.95	69.95
12G09-292	Standard & Creamer	46.95	48.95	50.95

Catalog No.	Description	24+	12+	Each
12G09-293	Standard Only (Chrome)	21.95	23.95	25.95
12G09-290	Standard Only (S/S)	39.95	42.95	45.95
12G09-291	Standard Only (PVD Gold)	45.95	48.95	52.95

Forward Sealing Faucets

Edge-Tap Faucets



CMBecker
INTERNATIONAL, LLC

BOTH FAUCETS
INCLUDE THE
CREAMER FUNCTION



Krome
dispense

Catalog No.	Faucet Style	24+	12+	Each
12B09-100	Standard only	36.95	38.95	40.95
12B09-110	Extended Spout	38.95	40.95	42.95

Catalog No.	Faucet Style	24+	12+	Each
12K02-112	Standard only	19.95	20.95	22.95
12K02-111	Extended Spout	26.50	26.95	27.95



304 Stainless Steel Standard Faucet

HIGH QUALITY • NSF LISTED
AFFORDABLY PRICED

12U07-119

24+ **\$14.95** 12+ **\$15.95** Each **\$16.95**



Forward Sealing Faucets, Edge-Tap Faucets

Traditional Style Stout Faucets

FOR USE WITH LOWER CARBONATED STOUTS, ALES, NITRO BEERS AND COFFEES
 PULL FORWARD TO POUR AND PUSH BACK TO PROVIDE A RICH, CREAMY HEAD



NSF

304 S/S



304 S/S

Krome dispense



PLATED BRASS

CHROME

Krome dispense



PLATED BRASS

TARNISH FREE PVD

Krome dispense

Catalog No.	Description	12+	6+	Each
12U07-120	304 S/S w/Handle	66.95	70.95	76.95
12K07-120	304 S/S (Krome Dispense)	42.95	43.95	45.95

Catalog No.	Description	12+	6+	Each
12K07-100	Plated Brass (Chrome)	28.95	29.95	30.95
12K07-110	Plated Brass (PVD Gold)	35.95	36.95	38.95

Stout Faucets



304 S/S

TAPRITE



TARNISH FREE PVD

304 S/S

TAPRITE



316 S/S

ads



TARNISH FREE PVD

316 S/S

ads

Catalog No.	Description	12+	6+	Each
12S07-161	304 S/S (Taprite)	73.95	78.95	85.95
12S07-160	304 S/S-PVD (Taprite)	73.95	78.95	85.95

Catalog No.	Description	12+	6+	Each
12B03-121	316 S/S (ADS2)	87.95	93.95	102.95
12B03-122	316 S/S-PVD (ADS2)	112.95	120.95	131.95



Creamer Faucets

PULL FORWARD TO POUR BEER THEN PUSH BACK TO CREATE A RICH, CREAMY HEAD



PLASTIC AND STAINLESS STEEL



PLASTIC AND STAINLESS STEEL



PLATED BRASS



Catalog No.	Description	12+	6+	Each
12B07-101	Plastic and S/S (Chrome)	23.95	25.95	27.95
12B07-102	Plastic and S/S (Gold)	26.95	28.95	30.95

Catalog No.	Description	12+	6+	Each
12K02-105	Plated Brass (Chrome)	12.50	12.95	13.95
12K02-106	304 Stainless Steel	17.95	18.50	18.95

STANDARD CREAMER PLUS FLOW CONTROL



STANDARD CREAMER ONLY



Catalog No.	Description	12+	6+	Each
12G09-294	304 S/S (w/Flow Control)	59.95	63.95	69.95

Catalog No.	Description	12+	6+	Each
12G09-292	304 Stainless Steel	46.95	48.95	50.95

Self-Closing Faucets

12K02-108 CHROME PLATED BRASS

12+ \$10.50
6+ \$10.95 Ea. \$11.50



12K02-109 304 STAINLESS STEEL

12+ \$19.95
6+ \$20.95 Ea. \$21.95



12S07-122 CHROME PLATED BRASS

12+ \$14.95
6+ \$15.95 Ea. \$17.95



Creamer and Self-Closing Faucets

Adjustable Flow Control Faucets

ALLOWS YOU TO ACHIEVE A PERFECT POUR BY ADJUSTING THE AMOUNT OF RESTRICTION ON THE FLOW

PERFECT FOR HARD-TO-POUR BEERS, SAMPLERS AND FROSTED GLASS POURS



FLOW CONTROLLED STOUT

PLASTIC & CHROME WITH 304 S/S LEVER
Fits directly onto all American Shanks

Catalog No.	6+	3+	Each
12B03-123	122.95	131.95	142.95



FORWARD SEALING

INCLUDES CREAMER FUNCTION

304 STAINLESS STEEL WITH 304 S/S LEVER
Fits directly onto all American Shanks

Catalog No.	12+	6+	Each
12G09-294	59.95	63.95	69.95



304 STAINLESS STEEL WITH 304 S/S LEVER
Fits directly onto all American Shanks

Catalog No.	12+	6+	Each
12G09-301	49.95	53.95	57.95

FOOD GRADE LINED PLATED BRASS SHANK



AVAILABLE IN 2-1/2" LENGTH

304 GRADE STAINLESS STEEL SHANKS



AVAILABLE IN 4 DIFFERENT LENGTHS



MADE IN GERMANY



SELF CLOSING MODELS

PLASTIC AND 304 S/S LIQUID CONTACT



INCLUDES CREAMER FUNCTION

Ref. #	Catalog No.	Length	6+	3+	Each
1	12C03-301	2-1/2"	9.95	10.50	10.95
2	12C03-310	2-1/2"	16.50	17.25	17.95
2	12C03-311	4-1/8"	-	-	20.95
2	12C03-312	5-3/8"	36.95	38.95	39.95
2	12C03-313	8-3/8"	60.95	62.95	64.95

Ref. #	Catalog No.	6+	3+	Each
3	12C03-300	31.95	33.95	36.95
4	12C03-304	86.95	92.95	101.95

Flow Control Faucets

Chrome Plated or PVD Gold Finished WITH STAINLESS LEVER AND SPOUT

Has a 1-1/4" length flow control shank (5/8" BSP Beer Thread)

SHANK MUST BE USED WITH FAUCET

Ref. #	Catalog No.	Color	6+	3+	Each
1	12U07-100	Chrome	51.95	54.95	59.95
2	12U07-101	PVD Gold	51.95	54.95	59.95

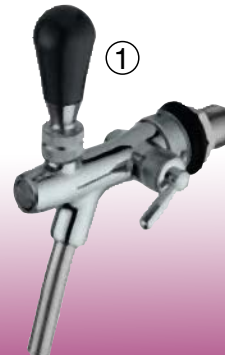

Standard Faucet Replacement Parts

FOR STANDARD FAUCET MODELS FROM:



PARTS FOR:
 Chrome Plated
 Solid Brass
 Stainless Steel
 PVD Gold

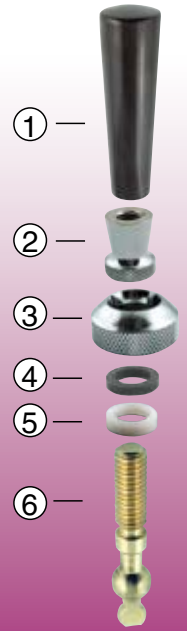
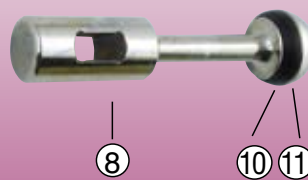

Additional price breaks available on most items. Login to your website account or contact your sales representative for pricing.

		ABECO, KROME & TAPRITE STANDARDS				PERLICK STANDARDS			
Ref.#	Description	Catalog No.	50+	25+	Each	Catalog No.	50+	25+	Each
1	Knob (long)	12G09-126	0.97	1.02	1.11	12G09-126	0.97	1.02	1.11
1	Knob with Brass insert (long)	12K02-200	1.45	1.55	1.95	12K02-200	1.45	1.55	1.95
1	Knob (round)	12B03-163	1.31	1.39	1.46	12B03-163	1.31	1.39	1.46
Ref.#	Description	Catalog No.	25+	10+	Each	Catalog No.	25+	10+	Each
2	Collar (chrome)	12B03-165	1.42	1.51	1.58	12G09-127	4.42	4.70	4.93
2	Collar (brass)	12B03-164	1.54	1.64	1.72	12G09-128	9.63	10.24	10.74
2	Collar (PVD Gold)	12B03-100	6.49	6.89	7.23	-	-	-	-
3	Bonnet (chrome)	12B03-167	1.34	1.43	1.50	12G09-129	3.10	3.30	3.46
3	Bonnet (brass)	12B03-166	1.54	1.64	1.72	12G09-120	3.16	3.36	3.52
3	Bonnet (PVD Gold)	12B03-101	4.63	4.92	5.16	-	-	-	-
Ref.#	Description	Catalog No.	500+	100+	Each	Catalog No.	100+	50+	Each
4	Washer, friction	12B03-168	0.18	0.19	0.23	12G09-131	0.20	0.25	0.30
5	Ring, friction	12B03-169	0.23	0.24	0.29	12G09-132	0.23	0.24	0.29
Ref.#	Description	Catalog No.	50+	25+	Each	Catalog No.	25+	10+	Each
6	Lever (brass)	12B03-171	1.40	1.50	1.60	12G09-166	3.69	3.95	4.11
6	Lever (stainless steel)	12B03-170	1.65	1.95	2.50	12G09-167	5.29	5.58	5.90
Ref.#	Description	Catalog No.	500+	100+	Each	Catalog No.	500+	100+	Each
7	Washer, faucet	12B03-173	0.18	0.19	0.23	12G09-111	0.70	0.80	0.95
Ref.#	Description	Catalog No.	25+	10+	Each	Catalog No.	25+	10+	Each
8	Plunger shaft only (chrome)	12B03-174	2.42	2.58	2.70	12G09-104	9.12	9.69	10.16
8	Plunger shaft only (brass)	12B03-102	3.24	3.45	3.61	12G09-105	8.62	9.16	9.61
8	Plunger shaft only (PVD Gold)	12B03-103	DISCONTINUED			-	-	-	-
8	Plunger shaft only (stainless steel)	12B03-104	7.26	7.71	8.09	-	-	-	-
9	Complete plunger assembly (chrome)	12B03-175	3.78	4.02	4.22	12G09-106	10.06	10.69	11.21
9	Complete plunger assembly (brass)	12A03-150	4.17	4.43	4.65	12G09-107	3.95	4.50	4.95
9	Complete plunger assembly (PVD Gold)	12B03-105	DISCONTINUED			-	-	-	-
9	Complete plunger assembly (stainless steel)	12B03-106	7.95	8.95	9.95	-	-	-	-
Ref.#	Description	Catalog No.	100+	50+	Each	Catalog No.	50+	25+	Each
10	Washer, plunger	12B03-176	0.32	0.34	0.45	12G09-136	0.32	0.34	0.41
Ref.#	Description	Catalog No.	25+	10+	Each	Catalog No.	25+	10+	Each
11	Nut, plunger (universal to all colors)	12B03-177	0.49	0.53	0.55	12G09-137	-	-	-

Replacement Parts for Standard Faucets

Perlick 425 Series & 500 Series Replacement Parts



425 Series Models
FITS DISCONTINUED FAUCETS



525 & 575 Series Models

Replacement Parts for Perlick Specialty Faucets

Additional price breaks available on most items. Login to your website account or contact your sales representative for pricing.

OLDER DISCONTINUED FAUCETS
425 SERIES
Replacement Parts

Ref.#	Catalog No.	Description	50+	25+	Each
1	12G09-126	Knob (long)	0.97	1.02	1.11
1	12B03-163	Knob (round)	1.31	1.39	1.46
Ref.#	Catalog No.	Description	100+	50+	Each
2	12G09-179	Bonnet (chrome)	-	-	3.56
2	12G09-180	Bonnet (PVD Gold)	-	-	8.16
3	12G09-131	Washer (rubber)	0.20	0.25	0.30
4	12G09-185	Bearing Cup	0.44	0.47	0.50
5	12G09-186	O-ring	0.15	0.17	0.19
6	12G09-183	Spout (S/S)	-	-	7.44
6	12G09-184	Spout (PVD Gold)	-	-	12.95
6	12G09-181	Spout (plastic - black)	4.04	4.30	4.51
7	12B03-173	Washer, faucet	0.18	0.19	0.23
8	12G09-189	O-ring, plunger	0.08	0.10	0.15
9	12G09-100	Kit (S/S Lever, S/S Plunger, Chrome Collar)	-	17.95	18.95
9	12G09-101	Kit (S/S Lever, S/S Plunger, PVD Gold Collar)	-	-	23.95
9	12G09-102	Kit (S/S Lever, Plastic Plunger, Chrome Collar)	-	12.95	13.95
9	12G09-103	Kit (S/S Lever, Plastic Plunger, PVD Gold collar)	-	-	17.95
10	12G09-187	Faucet cleaning adapter	-	-	16.95

Perl
525 & 575 SERIES
Replacement Parts

Ref.#	Catalog No.	Description	50+	25+	Each
1	12G09-126	Knob (long)	0.97	1.02	1.11
1	12B03-163	Knob (round)	1.31	1.39	1.46
Ref.#	Catalog No.	Description	100+	50+	Each
2	12G09-199	Collar (chrome)	-	-	4.93
2	12G09-200	Collar (PVD Gold)	-	-	10.24
3	12G09-197	Bonnet (chrome)	-	-	2.43
3	12G09-198	Bonnet (PVD Gold)	-	-	2.25
4	12G09-186	O-ring	0.15	0.17	0.19
5	12G09-188	Bearing cup	1.71	1.82	1.91
6	12G09-201	Lever (S/S)	-	-	4.17
7	12G09-202	Lever (S/S) with push-back creamer feature	-	-	15.95
8	12G09-195	O-ring (lever seat)	0.12	0.15	0.20
9	12B03-173	Washer, faucet	0.18	0.19	0.23



Perlick 6XX Series (Forward Sealing) Replacement Parts

MATCH THE PART NUMBERS TO THE MODEL TYPES PICTURED BELOW

Ref. #	Catalog No.	Description	Fits Models	25+	10+	Each
1	12G09-310	Collar (Chrome)	1,2,3,4	4.06	4.24	4.50
1	12G09-311	Collar (PVD Gold)	1,2	8.68	9.06	9.63
2	12G09-312	Bonnet (Chrome)	1,2,3,4	2.62	2.74	2.91
2	12G09-313	Bonnet (PVD Gold)	1,2	7.13	7.44	7.91
3	12G09-314	Gasket, Bonnet	1,2,3,4	0.27	-	0.29
4	12G09-315	Bearing Cup	1,2,3,4	1.91	2.03	2.13
5A	12G09-316	Lever (S/S)	1,3	11.75	12.27	13.04
5B	12G09-321	Lever, Creamer (S/S)	2,4	14.71	15.36	16.32
Ref. #	Catalog No.	Description	Fits Models	100+	50+	Each
6	12G09-302	O-ring, Pivot Ball	1,2,3,4	0.13	0.14	0.16
7	12G09-317	O-ring, Front Seat	1,2,3,4	0.40	0.45	0.50
Ref. #	Catalog No.	Description	Fits Models	500+	100+	Each
8	12G09-111	Washer, Faucet	1,2,3,4	0.70	0.80	0.95
Ref. #	Catalog No.	Description	Fits Models	25+	10+	Each
9	12G09-318	Compensator, Flow Control	3,4	5.20	5.43	5.77
Ref. #	Catalog No.	Description	Fits Models	50+	25+	Each
10	12G09-319	Seal Kit, Flow Control	3,4	2.62	2.78	2.92
Ref. #	Catalog No.	Description	Fits Models	25+	10+	Each
11	12G09-320	Lever/Seal Kit, Flow Control	3,4	11.75	12.27	13.04

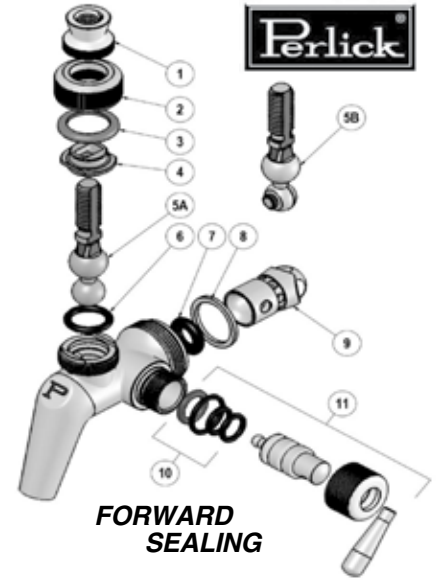

FORWARD SEALING

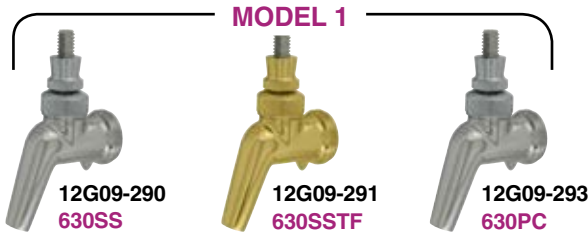

Additional price breaks available on most items. Login to your website account or contact your sales representative for pricing.



ADS2 Stout Faucet Replacement Parts

Catalog No.	Description	25+	10+	Each
12B03-128	Nozzle (Plastic)	4.70	4.90	5.47
12B03-129	Flow Straightener	1.24	1.29	1.44
12B03-130	Restrictor Disc (S/S)	4.56	4.84	5.08
12C07-580	O-ring	-	-	0.15



ADS2 Flow Control Replacement Parts

Catalog No.	Description	10+	5+	Each
12B03-125	Nozzle (Plastic)	4.90	5.21	5.47
12B03-126	Flow Straightener	1.29	1.37	1.44
12B03-127	Restrictor Disc (Plastic)	4.56	4.84	5.08
12A06-139	O-ring	-	-	0.15

Krome Dispense Taprite & Draught Tech Stout Faucet Replacement Parts

Ref. #	Catalog No.	Description	10+	5+	Each
1	12S07-166	Screw (S/S)	2.46	2.61	2.95
2	12S07-167	Sliding Cap (Plastic)	3.12	3.32	3.48
3	12S07-168	O-ring (Sliding Cap)	1.94	2.06	2.16
4	12S07-170	Spring(S/S)	1.38	1.46	1.55
5	12S07-173	Piston (S/S)	-	-	14.95
6	12S07-171	Pin (S/S) Older models	0.57	0.60	0.63
6	12S07-175	Set Screw (S/S)	-	-	0.63
7	12S07-174	O-ring (Upper Piston)	1.14	1.21	1.27
8	12S07-179	O-ring (Lower Piston)	0.99	1.05	1.10
9	12S07-165	O-ring (Body/Nozzle)	1.14	1.21	1.27
10	12S07-162	Restrictor Plate (S/S)	4.95	5.50	5.95
11	12S07-163	Flow Straightener	1.80	1.92	2.01
12	12S07-164	Nozzle (S/S)	8.50	8.95	9.50
13	12B03-173	Faucet Washer	-	-	0.23

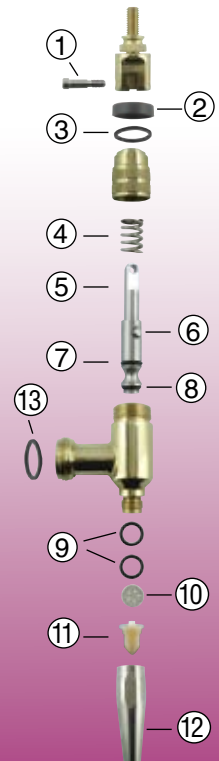

Foxx Equipment can supply replacement parts for a wide variety of faucets. Call your sales representative for pricing and availability

High Quality Ceramic Handles

EUROPEAN CERAMIC WITH EXCELLENT GLAZE PAINT • TRIMMED IN CHROME OR GOLD HARDWARE



MODEL
A113

HEIGHT
12-3/4"

WIDTH
3-1/4"



MODEL
A57

HEIGHT
11"

WIDTH
3"

CHROME HARDWARE		
Catalog No.	Color	Each
12U07-500	White	30.95
12U07-501	Black	30.95
12U07-502	Red	30.95

GOLD HARDWARE		
Catalog No.	Color	Each
12U07-510	White	30.95
12U07-511	Black	30.95
12U07-512	Red	30.95

CHROME HARDWARE		
Catalog No.	Color	Each
12U07-560	White	28.95
12U07-561	Black	28.95
12U07-562	Red	28.95

GOLD HARDWARE		
Catalog No.	Color	Each
12U07-570	White	28.95
12U07-571	Black	28.95
12U07-572	Red	28.95



MODEL
A5

HEIGHT
4-1/4"

WIDTH
2-1/4"



MODEL
A65

HEIGHT
11-3/4"

WIDTH
2"

CHROME HARDWARE		
Catalog No.	Color	Each
12U07-540	White	25.95
12U07-541	Black	25.95
12U07-542	Red	25.95

GOLD HARDWARE		
Catalog No.	Color	Each
12U07-550	White	25.95
12U07-551	Black	25.95
12U07-552	Red	25.95

CHROME HARDWARE		
Catalog No.	Color	Each
12U07-520	White	28.95
12U07-521	Black	28.95
12U07-522	Red	28.95

GOLD HARDWARE		
Catalog No.	Color	Each
12U07-530	White	28.95
12U07-531	Black	28.95
12U07-532	Red	28.95

Additional price breaks available on most items. Login to your website account or contact your sales representative for pricing.

Handle Inserts

FOR REPLACEMENT OR NEW PUB HANDLE

CONSTRUCTION

12G02-104

100+ **.40**

50+ 0.50 Ea. 0.60



- Manufactured of brass
- 3/8"-16 internal thread
- 5/8" overall length
- Slotted drive for install
- Drill size 1/2"

- Manufactured of brass
- 3/8"-16 internal thread
- 3/4" overall length
- Epoxy resin installation
- Drill size 5/8"



12K02-204

100+ **.45**

50+ 0.50 Ea. 0.65

Faucet Plug

FOR CAPPING OFF FAUCETLESS SHANKS



- Solid brass plug
- Washer included

12K02-210

25+ **\$3.50**

10+ \$3.95 Ea. \$4.95



Faucet Knobs

**ROUND KNOB
(NO INSERT)**

12B03-163



100+ **0.87**
50+ 0.97
25+ \$1.02
Ea. \$1.11

**OBLONG KNOB
(WITH INSERT)**

12K02-200



100+ **\$1.40**
50+ \$1.45
25+ \$1.55
Ea. \$1.95

**OBLONG KNOB
(NO INSERT)**

12G09-126



100+ **\$1.24**
50+ \$1.31
25+ \$1.39
Ea. \$1.46

Additional price breaks available on most items. Login to your website account or contact your sales representative for pricing.

**4.75" LONG KNOB
(PLATE BRASS)**

CHROME

12U07-121



50+ **\$10.95**
25+ \$11.95
10+ \$12.95
Ea. \$13.95

**OBLONG KNOB
(PLATE BRASS)**

CHROME

12K02-201



50+ **\$4.60**
25+ \$4.70
10+ \$4.92
Ea. \$5.16

**OBLONG KNOB
(PLASTIC)**

MATTE

12K02-211



50+ **\$1.38**
25+ \$1.50
10+ \$1.60
Ea. \$1.75

Bonnet Anglers

KEEPS PUB HANDLES UPRIGHT INSTEAD OF BEING TILTED BACK IN THE OFF POSITION

100+ **\$1.50**
50+ \$1.70
25+ \$1.80
Ea. \$1.95

CHROME

12E07-120



25+ **\$2.95**
10+ \$3.50
Ea. \$3.95

TARNISH FREE
PVD

12A03-174



Handle Extensions

ADJUSTS HEIGHT OF PUB HANDLES

12A03-119

1" EXTENSION

25+ **\$1.10**

10+ \$1.15 Ea. \$1.25

12A03-120

2" EXTENSION

25+ **\$1.95**

10+ \$2.05 Ea. \$2.25



Faucet Knobs and Accessories

Faucet Lockouts

STOPS UNAUTHORIZED POURING OF BEER • TAMPER-PROOF • ALL LOCKS ARE KEYED ALIKE

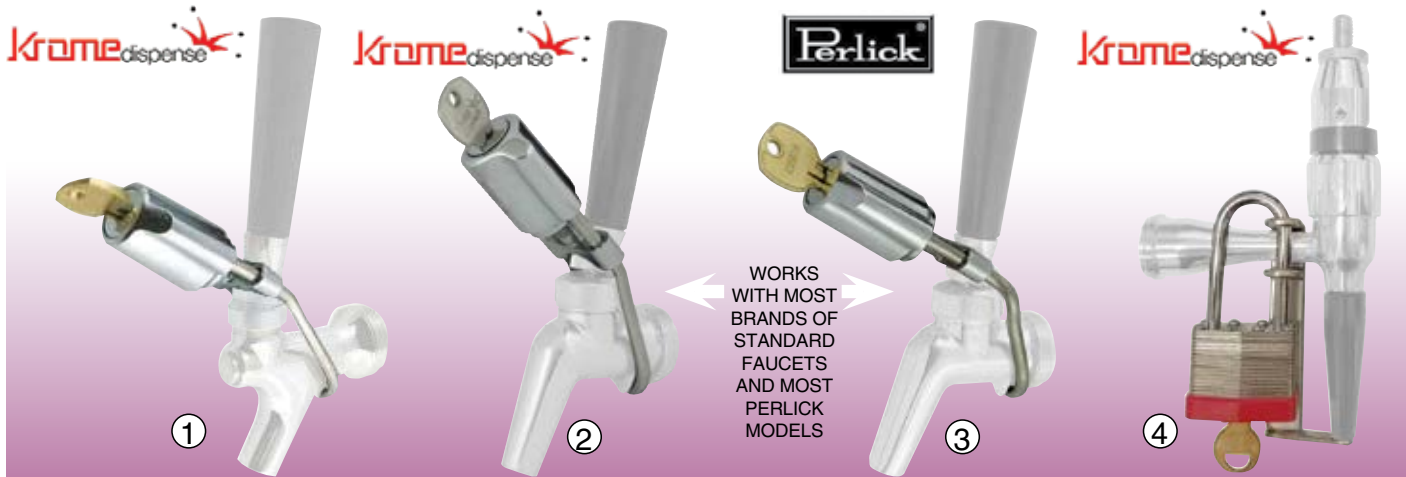

WORKS WITH MOST BRANDS OF STANDARD FAUCETS AND MOST PERLICK MODELS

Ref. #	Catalog No.	Fits Faucet Types	25+	10+	Each
1	17K03-100	Standards and Perls	19.95	21.95	22.95
2	17K03-120	Standards & Old/New Perlicks	22.95	23.95	24.95

Ref. #	Catalog No.	Fits Faucet Types	25+	10+	Each
3	17B03-120	Standards & Old/New Perlicks	45.95	48.95	50.95
4	17K03-103	ADS2 & MicroMatic Stouts	14.95	16.95	18.95

Additional price breaks available on most items. Login to your website account or contact your sales representative for pricing.

Kleen Plug

KEEPS YOUR FAUCETS CLEAN AND SANITARY WITH KLEEN PLUG™

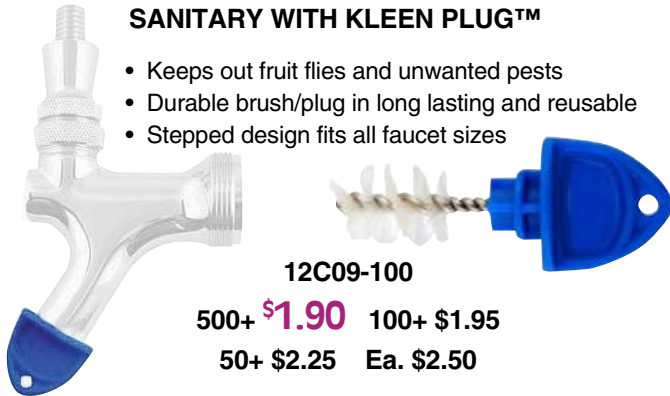

- Keeps out fruit flies and unwanted pests
- Durable brush/plug in long lasting and reusable
- Stepped design fits all faucet sizes

12C09-100

500+ \$1.90 100+ \$1.95
50+ \$2.25 Ea. \$2.50

Faucet Cap

HELPS KEEP YOUR FAUCETS CLEAN AND SANITARY



- Curved pull-tab provides easy removal of cap
- Soft vinyl with gloss finish
- 2-1/4" length

FITS MOST STYLES OF FAUCETS

12A09-100

500+ 0.12¢ 100+ 0.15¢
50+ 0.17¢ Ea. 0.20¢



Growler Filling Tubes

PERFECT FOR FILLING ALL TYPES/SIZES OF GROWLERS • ATTACHES TO FAUCET • 12" LENGTH

Fits: MOST STANDARD FAUCETS

Faucet not included

12K02-205

50+ \$2.50 25+ \$2.75
10+ \$2.95 Ea. \$3.50

Fits: Perlick (OLD) Perlick

Faucet not included

12K02-207

50+ \$3.25 25+ \$3.50
10+ \$3.75 Ea. \$3.95

Fits: Perlick (NEW) FORWARD SEALING

Faucet not included

12G09-207

50+ \$3.50 25+ \$3.95
10+ \$4.50 Ea. \$4.95

Faucet Locks, Caps, Plugs and Growler Filling Tubes





"A FLY KILLER!"

KILLS ALL FLIES, COCKROACHES & SPIDERS

- Guaranteed Elimination In Under 24 Hours
- All New Time Released Vapor Technology
- Clean, Safe & Odorless

PROTECTION FOR UP TO 4 MONTHS

KILLS UNWANTED PESTS FAST

INCLUDING BUT NOT LIMITED TO:
FRUIT FLIES, FLIES, GNATS, COCKROACHES, SILVERFISH



DRINK AND FOOD AREAS – ONLY USE AFTER HOURS IN UNOCCUPIED AREAS

20B05-100

SOLD BY CASE OF 10 STRIPS

12cs+ **\$72.95** 6cs + **\$74.95**
 3cs+ **\$76.95** 1cs + **\$78.95**

FRUIT FLY Bar Pro is a highly effective pest eliminator

- Time-released vapor fills every crack and crevice in a 200 cubic foot area per strip
- Attacks the problem at the source, targeting hard-to-reach reproducing areas
- Kills infestation within 24 hours and used regularly, will provide protection for up to four months before replacement is needed

THIS PRODUCT IS REGULATED AND APPROVED BY THE EPA FOR SALE IN ALL 50 STATES

Insect-Away Gel and Spray

ALL NATURAL INSECTICIDE – HEALTHY TO BREATHE

SPRAY DRAINS TO CONTROL FRUIT FLIES

- SPRAY INFORMATION**
- Kills many insects on contact
 - Scent works as a strong repellent for fruit flies and flies
 - World-Wise certified
 - Made from renewable resources
 - Features Fresh Air™ technology
 - Pleasant peppermint scent

- GEL CUP INFORMATION**
- Repels fruit flies and flies
 - World-Wise certified
 - Made from renewable resources
 - Features Fresh Air™ technology
 - Pleasant peppermint scent
 - Each gel cup lasts up to 30 days



Catalog No.	Description	6+	3+	Each
20G09-300	Spray (16 oz.)	11.95	12.95	13.95
20G09-301	Gel Cup (2 oz.)	4.75	5.00	5.50

Commercial FlyPunch!

POP THE TOP AND FRUIT FLIES CAN'T RESIST

SAFELY AND EFFECTIVELY KILLS FRUIT FLIES FAST

- Powerful non-toxic formula
- More effective than other similar types of products on the market
- Safe to use in all food/beverage areas
- Safe to use around employees and patrons
- Increases patron satisfaction
- Reduces risk of food borne illness
- Covers approx. 500 cubic feet and is most effective for up to 2 weeks



20A05-100 FlyPunch!
 12+ **\$6.75** Ea. **\$6.95**

20A05-101 Wall Bracket
 12+ **\$3.35** Ea. **\$4.00**

Fruit Fly and Pest Control Products

KROME DISPENSE American Sanke Couplers

KROME DISPENSE couplers give you the best of both worlds—high quality product and exceptional value. KROME couplers come with either a stainless steel body & handle yoke or a nickel plated brass body & handle yoke.



S/S Body
 24+ **\$21.95**
 12+ \$22.95
 Ea. \$24.95



07K07-100



07K07-101



07K07-102

OR



07K07-108

Brass Body
 24+ **\$17.50**
 12+ \$17.95
 Ea. \$18.95

TAPRITE American Sanke Couplers

TAPRITE couplers have a quality chrome plated brass body to provide a long lasting, durable product. Specially designed pressure inlet nipple and check valve eliminates the need for a coupling washer.



07S07-122



07A03-125



07S07-125



07S07-126

24+ **\$23.95**
 12+ \$25.95
 Ea. \$27.95

Additional price breaks available on most items. Login to your website account or contact your sales representative for pricing.

ABECO American Sanke Couplers

All ABECO sanke couplers are NSF listed. ABECO couplers have a nickel plated forged brass body to provide years of trouble-free service. The "shorty" handle allows easy installation on all American sanke kegs. These are high quality couplers at an affordable price.



07A03-127



07A03-128



07A03-129



07A03-130



24+ **\$24.95**
 12+ \$25.95
 Ea. \$27.95

PERLICK American Sanke Couplers

All PERLICK couplers have a nickel plated brass body. Offered with a non-rotating probe or a 360° rotating probe (helps prevent twisting lines).



**STANDARD
NON-ROTATING
PROBE**

07G09-113

24+ **\$34.95**
 12+ \$36.95 Ea. \$39.95



**360°
ROTATING
PROBE**

07G09-111

24+ **\$40.95**
 12+ \$43.95 Ea. \$47.95

American Sanke Key Couplers



304 Stainless Steel American or European Sanke Coupler

KROME models have a 304 grade stainless steel body, yoke handle and probe. Will provide years of trouble-free service





07K07-106
AMERICAN SANKE

24+ **\$26.50**
 12+ \$26.95 Ea. \$28.95





07K07-107
EUROPEAN SANKE

24+ **\$26.50**
 12+ \$26.95 Ea. \$28.95

304 Stainless Steel Probe American Sanke Coupler







ABECO model has a nickel plated forged brass body and a 304 grade stainless steel probe. This model is NSF listed and will provide years of trouble-free service

07S07-100 "SHORTY" HANDLE

24+ **\$36.95** 12+ \$38.95 Ea. \$41.95

Additional price breaks available on most items. Login to your website account or contact your sales representative for pricing.

Low Profile American Sanke Couplers

Great for use where kinks in the lines could pose an issue – perfect for use with keg spacers



07G09-207

24+ **\$62.95**
 12+ \$67.95 Ea. \$73.95



07S07-135

24+ **\$47.95**
 12+ \$51.95 Ea. \$55.95



07K09-100

24+ **\$26.95**
 12+ \$27.95 Ea. \$29.95

Wing Handle American Sanke Couplers

ABECO couplers have a durable nickel plated forged brass body to provide years of trouble-free service. These are high quality couplers at affordable prices. All ABECO couplers are NSF listed.



07K09-111
PHENOLIC RESIN HANDLE

24+ **\$22.95**
 12+ \$24.95 Ea. \$26.95





07K09-113
PLATED METAL HANDLE

24+ **\$26.95**
 12+ \$28.95 Ea. \$31.95

304 S/S Probe, Low Profile and Wing Handle Sanke Keg Couplers

European Sanke Couplers

All couplers listed are high quality name brand products and will provide years of trouble-free service.



STAINLESS STEEL BODY

Catalog No.	24+	12+	Each
07K07-105	21.95	22.95	24.95



CHROME PLATED BRASS BODY

Catalog No.	24+	12+	Each
07S07-123	23.95	25.95	27.95



NICKEL PLATED FORGED BRASS BODY

Catalog No.	24+	12+	Each
07A03-126	25.95	26.95	29.95



CHROME PLATED BRASS BODY

Catalog No.	24+	12+	Each
07G09-115	43.95	46.95	50.95

Additional price breaks available on most items. Login to your website account or contact your sales representative for pricing.



Import Beer Keg Couplers



304 GRADE S/S PROBE • PLATED BRASS BODY • PRESSURE RELIEF VALVE • GAS CHECK VALVE

A
SYSTEM



07K07-300

FOR USE WITH
BUT NOT LIMITED TO:
Paulaner, Spaten, Warsteiner

24+ **\$27.95**

12+ \$28.95 Ea. \$30.95

G
SYSTEM



07K07-301

FOR USE WITH
BUT NOT LIMITED TO:
Watneys, Anchor, Fuller's

24+ **\$31.95**

12+ \$32.95 Ea. \$34.95

U
SYSTEM



07K07-302

FOR USE WITH
BUT NOT LIMITED TO:
Guinness, Harp, Kilkenny

24+ **\$32.95**

12+ \$33.95 Ea. \$35.95

European Sanke and Krome Import Couplers



Import Beer Keg Couplers

TOF® has been certified ISO 9001 since 1997.

TOF® produces quality keg couplers at affordable prices



BRASS BODY WITH NSF 61 GALVANIC FOOD COATING • INOX AISI 300 S/S PROBE • PRESSURE RELIEF VALVE

A
SYSTEM



07T07-100

FOR USE WITH
BUT NOT LIMITED TO:
Paulaner, Spaten, Warsteiner

24+ \$45.95

12+ \$48.95 Ea. \$52.95

G
SYSTEM



07T07-101

FOR USE WITH
BUT NOT LIMITED TO:
Watneys, Anchor, Fuller's

24+ \$45.95

12+ \$48.95 Ea. \$52.95

U
SYSTEM



07T07-102

FOR USE WITH
BUT NOT LIMITED TO:
Guinness, Harp, Kilkenny

24+ \$45.95

12+ \$48.95 Ea. \$52.95

Additional price breaks available on most items. Login to your website account or contact your sales representative for pricing.



M
SYSTEM

07T07-103

FOR USE WITH
BUT NOT LIMITED TO:
Veltins, Schneider, Aventinus

24+ \$45.95

12+ \$48.95 Ea. \$52.95



K
SYSTEM

07T07-104

FOR USE WITH
KeyKeg

24+ \$45.95

12+ \$48.95 Ea. \$52.95



TOF Import Keg Couplers





ABECO Lever Couplers



Ref.#	Catalog No.	Description	25+	10+	Each
1	12J06-101	Ball Retainer	0.42	0.44	0.46
2	12J06-102	Check Ball	0.40	0.45	0.60
3	07K09-109	Probe Washer (American)	0.36	0.38	0.46
3	12J06-104	Probe Washer (European)	0.79	0.83	1.01
4	12J06-105	Body O-Ring	0.13	0.15	0.20
5	07K09-108	Bottom Seal Washer	0.57	0.60	0.74
6	12J06-106	Pressure Relief Valve	4.25	4.51	4.73
7	04B03-135	Beer Hex Nut	0.75	-	0.80
8	05C08-132	Tailpiece 5/16" Barb	0.65	-	0.70
9	12J06-110	Retainer for Check Valve	0.42	0.44	0.46
10	12J06-103	Check Valve	0.46	0.49	0.52
11	12J06-111	Hinge Pin	0.93	0.98	1.03
12	12J06-112	Nut for Hinge Pin	0.46	0.49	0.52
13	12J06-113	Yoke/Handle Assembly (White)	9.57	10.17	10.67
14	12J06-114	Plastic Handle Only (White)	1.62	1.72	1.81
14	12J06-117	Plastic Handle Only (Red)	1.62	1.72	1.81
14	12J06-118	Plastic Handle Only (Blue)	1.62	1.72	1.81
14	12J06-119	Plastic Handle Only (Gold)	1.62	1.72	1.81



Taprite Lever Couplers

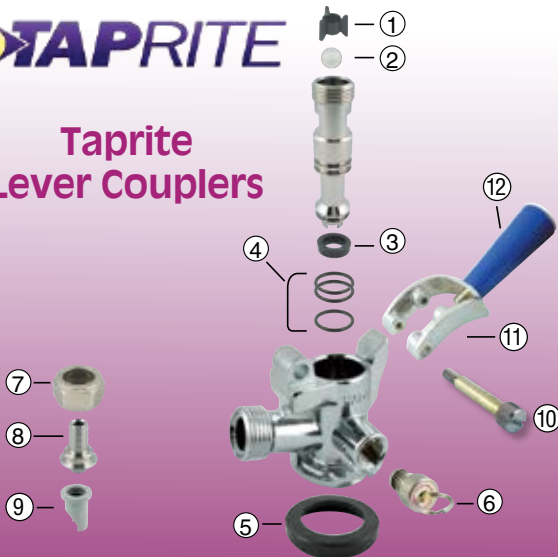

Ref.#	Catalog No.	Description	25+	10+	Each
1	12S07-106	Ball Retainer	0.17	0.20	0.25
2	12S07-107	Check Ball	0.45	0.48	0.51
3	07K09-109	Probe Washer (American)	0.36	0.38	0.46
3	12J06-104	Probe washer (European)	0.79	0.83	1.01
4	07S07-106	Body O-Ring	0.09	0.10	0.15
5	07K09-108	Bottom Seal Washer	0.57	0.60	0.74
6	07S07-107	Pressure Relief Valve	3.55	3.77	3.96
7	04B03-135	Beer Hex Nut	0.75	-	0.80
8	12S07-111	Gas Nipple 5/16" Barb	0.76	0.81	0.85
9	12S07-112	Check Valve	0.80	0.85	0.95
10	12S07-113	Hinge Pin	1.65	1.76	1.85
11	12S07-115	Yoke/Handle Assembly (Blue)	12.03	12.78	13.41
12	12S07-159	Plastic Handle Only (White)	0.95	1.01	1.06
12	12S07-172	Plastic Handle Only (Red)	0.95	1.01	1.06
12	12S07-119	Plastic Handle Only (Blue)	0.92	0.98	1.02
12	12S07-123	Plastic Handle Only (Gold)	0.95	1.01	1.06

Additional price breaks available on most items. Login to your website account or contact your sales representative for pricing.

Krome Lever Couplers



Ref.#	Catalog No.	Description	25+	10+	Each
1	12S07-106	Ball Retainer	0.17	0.20	0.25
2	12G09-143	Check Ball	0.66	0.70	0.74
3	07K07-200	Probe Washer (American)	0.60	0.65	0.95
3	07K07-208	Probe washer (European)	0.60	0.65	0.95
4	07K07-201	Body O-Ring (2 pc/Pkg)	0.65	0.70	0.75
5	07K07-202	Bottom Seal Washer	0.50	0.55	0.60
6	07K07-207	Pressure Relief Valve	3.10	3.25	3.50
7	04B03-135	Beer Hex Nut	0.75	-	0.80
8	12S07-111	Gas Nipple 5/16" Barb	0.76	0.81	0.85
9	12S07-112	Check Valve	0.80	0.85	0.95
10	07K07-206	Hinge Pin	1.95	2.10	2.25
11	07K07-203	Yoke/Handle Assembly (Black)	7.50	7.95	8.50
12	07K07-110	Plastic Handle Only (Black)	0.95	1.10	1.25
12	07K07-111	Plastic Handle Only (Red)	0.95	1.10	1.25
12	07K07-112	Plastic Handle Only (Yellow)	0.95	1.10	1.25

Replacement Parts for Sanke Key Couplers

Ref.#	Catalog No.	Description	25+	10+	Each
-	-	-	-	-	-
1	12J06-101	Ball Retainer	0.42	0.44	0.46
2	12J06-102	Check Ball	0.40	0.45	0.60
3	07S07-106	Probe O-Ring	0.09	0.10	0.15
4	07K09-109	Probe Washer	0.36	0.38	0.46
5	07K09-108	Bottom Seal Washer	0.57	0.60	0.74
6	12J06-106	Pressure Relief Valve	4.25	4.51	4.73
7	12J06-105	Body O-Ring	0.13	0.15	0.20
8	12J06-107	Spring	0.85	0.90	0.95
9	12J06-116	Retainer for Lexan Washer	0.23	0.25	0.26
10	12J06-115	Lexan Washer	0.39	0.41	0.43
11	12J06-108	Wing Handle (Black Plastic)	2.70	2.87	3.01
11	07A03-143	Wing Handle (Plated Metal)	5.79	6.15	6.45
12	12J06-109	Retainer Clip for Handle	0.54	0.57	0.60
13	04B03-135	Beer Hex Nut	0.75	-	0.80
14	05C08-132	Tailpiece 5/16" Barb	0.65	-	0.70
15	12J06-110	Retainer for Check Valve	0.42	0.44	0.46
16	12J06-103	Check Valve	0.46	0.49	0.52



ABECO Wing Couplers



Additional price breaks available on most items. Login to your website account or contact your sales representative for pricing.

Ref.#	Catalog No.	Description	25+	10+	Each
-	-	-	-	-	-
-	-	-	-	-	-
-	-	-	-	-	-
1	12G09-108	Ball Retainer	0.62	0.66	0.69
2	12G09-143	Check Ball	0.66	0.70	0.74
3	12G09-150	Probe Washer (American)	0.62	0.66	0.69
3	12G09-151	Probe Washer (European)	0.70	0.74	0.78
4	12G09-146	Body O-Ring	0.13	0.14	0.20
5	12G09-149	Bottom Seal Washer	0.82	0.87	0.91
6	12G09-110	Hinge Pin	1.91	2.03	2.13
7	12G09-109	Yoke/Handle Assembly (Black)	17.05	18.00	19.06
8	12G09-162	Plastic Handle Only (Black)	1.80	1.90	2.00
9	04B03-135	Beer Hex Nut	0.75	-	0.80
10	05C08-132	Tailpiece 5/16" Barb	0.65	-	0.70
11	04B03-132	Neoprene Beer Washer	-	-	0.25
12	12G09-147	Check Valve	1.32	1.40	1.47
13	N/A	Pressure Relief Valve	-	-	-



Perlick Lever Couplers

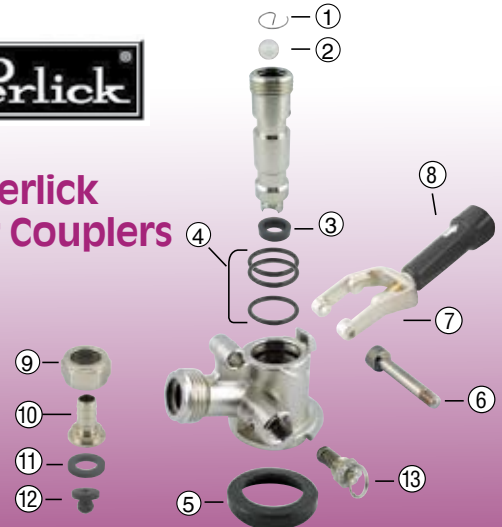
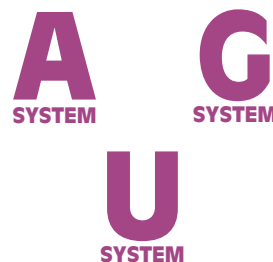

DIAGRAM FOR PART REPRESENTATION ONLY
(Look of actual part may vary)

Ref.#	Catalog No.	Description	25+	10+	Each
-	-	-	-	-	-
-	-	-	-	-	-
-	-	-	-	-	-
1	07S07-141	Ball Retainer	0.70	0.74	0.78
2	07S07-142	Check Ball	2.68	2.85	2.99
3	07S07-101	Probe O-ring (A,G)	0.61	0.65	0.68
3	07S07-102	Probe O-ring (U)	0.36	0.39	0.45
4	N/A	Hinge Pin	-	-	-
5	N/A	Fork/Handle Assembly	-	-	-
6	N/A	Pressure Relief Valve	-	-	-
7	07S07-144	Bottom Seal (A,G)	1.29	1.39	1.45
7	07S07-145	Bottom Seal (U)	1.38	1.46	1.53
8	12S07-112	Gas Check Valve	0.80	0.85	0.95
9	12S07-111	Gas Nipple (Barbed)	0.76	0.81	0.85
10	04B03-135	Retainer Nut	0.70	-	0.80



Import Couplers



Replacement Parts for Sanke and Taprite® Import Couplers

A SYSTEM



Replacement Parts for 07T07-100

Ref.#	Catalog No.	Description	25+	10+	Each
1	12S07-106	Ball Retainer	0.17	0.20	0.25
2	12G09-143	Check Ball	0.66	0.70	0.74
3	07T07-200	Body O-ring (needs 2pc)	0.15	0.20	0.25
4	07T07-204	Hinge Pin	1.15	1.25	1.50
5	07T07-205	Fork/Handle Assembly	6.95	7.50	7.95
6	07T07-206	Pressure Relief Valve	3.95	4.25	4.50
7	07T07-207	Bottom Seal	0.85	0.90	0.95
8	12S07-112	Gas Check Valve	0.80	0.85	0.95
9	12S07-111	Gas Nipple (Barbed)	0.76	0.81	0.85
10	04B03-135	Retainer Nut	0.70	0.75	0.80

G SYSTEM



Replacement Parts for 07T07-101

Ref.#	Catalog No.	Description	25+	10+	Each
1	12S07-106	Ball Retainer	0.17	0.20	0.25
2	12G09-143	Check Ball	0.66	0.70	0.74
3	07T07-200	Body O-ring (needs 2pc)	0.15	0.20	0.25
4	07T07-204	Hinge Pin	1.15	1.25	1.50
5	07T07-205	Fork/Handle Assembly	6.95	7.50	7.95
6	07T07-206	Pressure Relief Valve	3.95	4.25	4.50
7	07T07-207	Bottom Seal	0.85	0.90	0.95
8	12S07-112	Gas Check Valve	0.80	0.85	0.95
9	12S07-111	Gas Nipple (Barbed)	0.76	0.81	0.85
10	04B03-135	Retainer Nut	0.70	0.75	0.80

Additional price breaks available on most items. Login to your website account or contact your sales representative for pricing.

U SYSTEM



Replacement Parts for 07T07-102

Ref.#	Catalog No.	Description	25+	10+	Each
1	12S07-106	Ball Retainer	0.17	0.20	0.25
2	12G09-143	Check Ball	0.66	0.70	0.74
3	07T07-201	Body O-ring	0.17	0.20	0.25
4	07T07-204	Hinge Pin	1.15	1.25	1.50
5	07T07-205	Fork/Handle Assembly	6.95	7.50	7.95
6	07T07-206	Pressure Relief Valve	3.95	4.25	4.50
7	07T07-209	Bottom Seal	0.65	0.75	0.95
8	12S07-112	Gas Check Valve	0.80	0.85	0.95
9	12S07-111	Gas Nipple (Barbed)	0.76	0.81	0.85
10	04B03-135	Retainer Nut	0.70	0.75	0.80
11	07T07-210	5/8" BSP Probe Adapter	8.95	9.50	9.95
12	07T07-202	O-Ring (Probe Adapter)	0.11	0.12	0.15
13	07T07-203	O-Ring (Probe)	0.10	0.11	0.15



Replacement Parts for 07T07-103

Ref.#	Catalog No.	Description	25+	10+	Each
1	12S07-106	Ball Retainer	0.17	0.20	0.25
2	12G09-143	Check Ball	0.66	0.70	0.74
3	07T07-200	Body O-ring (needs 2pc)	0.15	0.20	0.25
4	07T07-204	Hinge Pin	1.15	1.25	1.50
5	07T07-205	Fork/Handle Assembly	6.95	7.50	7.95
6	07T07-206	Pressure Relief Valve	3.95	4.25	4.50
7	07T07-207	Bottom Seal	0.85	0.90	0.95
8	12S07-112	Gas Check Valve	0.80	0.85	0.95
9	12S07-111	Gas Nipple (Barbed)	0.76	0.81	0.85
10	04B03-135	Retainer Nut	0.70	0.75	0.80
14	07T07-208	Probe Seal	0.30	0.35	0.50



Replacement Parts for 07T07-104

Ref.#	Catalog No.	Description	25+	10+	Each
1	12S07-106	Ball Retainer	0.17	0.20	0.25
2	12G09-143	Check Ball	0.66	0.70	0.74
3	07T07-200	Body O-ring (needs 2pc)	0.15	0.20	0.25
4	07T07-204	Hinge Pin	1.15	1.25	1.50
5	07T07-205	Fork/Handle Assembly	6.95	7.50	7.95
6	07T07-206	Pressure Relief Valve	3.95	4.25	4.50
7	07T07-207	Bottom Seal	0.85	0.90	0.95
8	12S07-112	Gas Check Valve	0.80	0.85	0.95
9	12S07-111	Gas Nipple (Barbed)	0.76	0.81	0.85
10	04B03-135	Retainer Nut	0.70	0.75	0.80
15	07T07-211	Probe O-ring	0.23	0.25	0.50



Additional price breaks available on most items. Login to your website account or contact your sales representative for pricing.

Replacement Parts for ABECO

DIAGRAM FOR PART REPRESENTATION ONLY – LOOK OF ACTUAL PART MAY VARY

Ref.#	Catalog No.	Description	25+	10+	Each
1	N/A	Ball Retainer	-	-	-
2	07A03-105	Check Ball	0.39	0.41	0.43
3	N/A	Body O-ring (need 2pc)	-	-	-
4	N/A	Hinge Pin	-	-	-
5	N/A	Fork/Handle Assembly	-	-	-
6	N/A	Pressure Relief Valve	-	-	-
7	07A03-100	Bottom Seal (A,G)	Closeout		1.95
7	N/A	Bottom Seal (U)	-	-	-
8	12S07-112	Gas Check Valve	0.76	0.81	0.85
9	12S07-111	Gas Nipple (Barbed)	0.76	0.81	0.85
10	04B03-135	Retainer Nut	0.70	0.75	0.80



Replacement Parts for Import Couplers

Beer Nuts, Wing Nuts and Beer Washer



Ref. #	Catalog No.	Description	100+	50+	25+	Each
1	04B03-135	Beer Nut (Plated Brass)	0.65	0.70	0.75	0.80
2	04C03-304	Beer Nut (304 S/S)	2.50	2.95	3.25	3.50
3	04B03-133	Wing Nut (Plated Brass/Nylon)	1.21	1.28	1.36	1.43

Ref. #	Catalog No.	Description	100+	50+	25+	Each
4	04K03-134	Wing Nut (Plated Brass) Krome	1.25	1.50	1.75	1.95
5	04B03-134	Wing Nut (Plated Brass)	2.32	2.46	2.58	2.81

Ref. #	Catalog No.	Description	1000+	500+	100+	Each
6	04B03-132	Beer Washer	0.08	0.09	0.10	0.25

ALL ITEMS ON THIS PAGE HAVE A 3/8" ID BORE AND ARE 5/8" BSP THREAD (COMMONLY KNOWN AS BEER THREAD)

Beer Thread Shutoff Valves



Ref. #	Catalog No.	Description	50+	25+	10+	Each
1	04B07-101	Shutoff (304 S/S) Foxx	16.95	17.95	18.95	19.95
2	04S07-101	Shutoff (304 S/S) MicroMatic	26.95	27.50	27.95	28.95

Ref. #	Catalog No.	Description	50+	25+	10+	Each
3	05K03-157	Swivel Shutoff (304 S/S) Krome	10.95	11.95	12.95	13.95
4	05B03-157	Swivel Shutoff (Plated Brass)	16.95	17.95	18.50	18.95

Additional price breaks available on most items. Login to your website account or contact your sales representative for pricing.

Beer Accessory Components

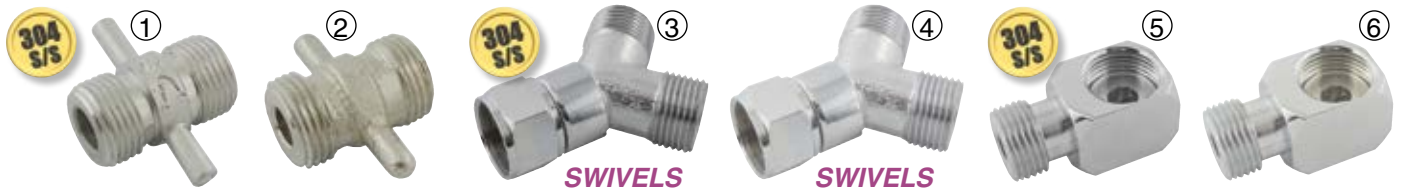

Ref. #	Catalog No.	Description	50+	25+	10+	Each
1	05K03-142	Duplex Coupling (304 S/S)	2.95	3.50	3.95	4.95
2	05A03-142	Duplex Coupling (Plated Brass)	11.09	11.58	12.30	12.91
3	05K03-151	Swivel "Y" Adapter (304 S/S)	6.95	7.50	7.95	8.50

Ref. #	Catalog No.	Description	50+	25+	10+	Each
4	05B03-151	Swivel "Y" Adapter (Plated Brass)	4.50	4.95	5.50	5.95
5	05K09-101	90° Adapter (304 S/S)	5.75	6.25	6.50	6.95
6	05C09-101	90° Adapter (Plated Brass)	6.25	6.50	6.75	7.50

Beer Cap and Washer



For capping off all 5/8" BSP (beer thread) components

04B03-136

50+ **\$2.25**

25+ \$2.50 10+ \$2.95

Ea. \$3.95



Beer Switch

Connects 2 kegs to 1 faucet. Manually switch to full keg when 1st keg empties.



05K03-141

10+ **\$37.95**

5+ \$39.95

Ea. \$41.95



304 Grade Stainless Steel Wall Brackets



①
STRAIGHT
3/8" B x 3/8" B



②
45° ANGLE
3/8" B x 3/8" B

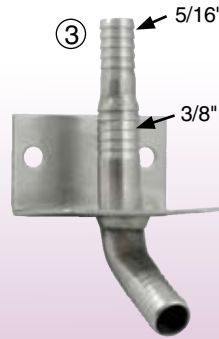

③
45° ANGLE
5/16" or 3/8" B x 3/8" B



④
STRAIGHT
3/8" B - All



⑤
45° ANGLE
3/8" B x MBT



⑥
45° ANGLE
MBT x MBT

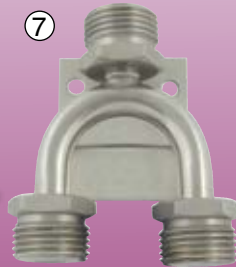

⑦
STRAIGHT
MBT x MBT x MBT



⑧
45° ANGLE
MBT x MBT



⑨
45° ANGLE
MBT x MBT x MBT

Ref.#	Catalog No.	Description	50+	25+	10+	Each
1	04C03-369	3/8" B x 3/8" B	2.50	2.95	3.50	3.95
2	04C03-362	3/8" B x 3/8" B	3.50	3.75	3.95	4.25
3	04C03-358	5/16" B x 3/8" B	5.50	5.75	6.25	6.50
4	04C03-371	3/8" B (All ends)	6.61	6.99	7.43	7.80
5	04C03-363	3/8" B x MBT	6.23	6.59	6.99	7.33

Ref.#	Catalog No.	Description	50+	25+	10+	Each
6	04C03-364	MBT x MBT	6.75	7.25	7.50	7.95
7	04C03-372	MBT (All Ends)	17.95	18.50	18.95	19.95
8	05K03-150	MBT x MBT	6.95	7.50	7.95	8.95
9	05K03-149	MBT (All Ends)	10.50	10.95	11.50	11.95

Additional price breaks available on most items. Login to your website account or contact your sales representative for pricing.



304 Grade Stainless Steel Beer Manifolds



04K03-402
2 Outlets

6+ **\$21.95**

3+ \$22.95 Ea. \$23.95



04K03-403
3 Outlets

6+ **\$28.95**

3+ \$29.95 Ea. \$30.95



04K03-404
4 Outlets

6+ **\$33.95**

3+ \$34.95 Ea. \$35.95

1/2" Barbed Inlet • Male "Beer Thread" 5/8" BSPP Outlets • 2" Diameter Cylinder

304 Stainless Steel Tail Pieces & Splicers



Catalog No.	Fits Vinyl Tubing I.D.	Fits Poly Tubing I.D.	100+	50+	25+	Each
04C03-318	1/4" MFL (with Hex for easy connection)		1.75	1.95	2.25	2.95
04C03-305	-	3/16"	1.18	1.26	1.32	1.50
04C03-101	3/16"	1/4"	1.80	1.90	2.00	2.10

Catalog No.	Fits Vinyl Tubing I.D.	Fits Poly Tubing I.D.	100+	50+	25+	Each
04C03-178	1/4" or 5/16"	5/16"	1.65	1.75	1.85	1.95
04C03-102	5/16" or 3/8"	3/8"	1.80	1.90	2.00	2.10
04C03-100	1/2"	1/2"	1.99	2.10	2.25	2.50



Catalog No.	Fits Vinyl Tubing I.D.	Fits Poly Tubing I.D.	100+	50+	25+	Each
05C03-103	3/16"	-	2.50	2.75	3.25	3.50
05C03-104	1/4"	1/4"	2.95	3.25	3.45	3.75
05C03-106	5/16"	5/16"	2.75	3.00	3.25	3.50

Catalog No.	Fits Vinyl Tubing I.D.	Fits Poly Tubing I.D.	100+	50+	25+	Each
-	-	-	-	-	-	-
05C03-107	3/8"	3/8"	3.00	3.25	3.50	3.75
05C03-108	1/2"	1/2"	4.50	4.75	5.00	5.50



Catalog No.	Fits Vinyl Tubing I.D.	Fits Poly Tubing I.D.	100+	50+	25+	Each
04C03-142	-	3/16" x 3/16"	1.25	1.35	1.45	1.75
04C03-351	-	3/16" x 1/4"	1.35	1.45	1.55	1.75
04C03-352	-	3/16" x 3/8"	2.00	2.25	2.50	2.95
04C03-139	3/16" or 5/16"	1/4" x 1/4"	0.80	0.85	0.90	1.00
04C03-366	3/16" or 1/4" x 5/16"	1/4" x 5/16"	0.70	0.80	0.85	0.95

Catalog No.	Fits Vinyl Tubing I.D.	Fits Poly Tubing I.D.	100+	50+	25+	Each
-	-	-	-	-	-	-
04C03-367	1/4" or 5/16"	5/16" x 5/16"	1.35	1.45	1.55	1.75
04C03-254	3/16" or 1/4" x 5/16" or 3/8"	1/4" x 3/8"	2.00	2.25	2.50	2.95
04C03-370	1/4" or 5/16" x 5/16" or 3/8"	5/16" x 3/8"	0.80	0.85	0.90	1.00
04C03-282	5/16" or 3/8"	3/8" x 3/8"	0.70	0.80	0.85	0.95

Additional price breaks available on most items. Login to your website account or contact your sales representative for pricing.

Plated Brass Tail Pieces & Splicers



TAIL PIECES						
Catalog No.	Fits Vinyl Tubing I.D.	Fits Poly Tubing I.D.	100+	50+	25+	Each
05C08-130	3/16"	1/4"	0.55	0.60	0.65	0.70
05C08-131	1/4"	5/16"	0.55	0.60	0.65	0.70
05C08-132	5/16"	3/8"	0.55	0.60	0.65	0.70
05C08-133	3/8"	-	0.55	0.60	0.65	0.70
05C08-134	1/2"	-	0.55	0.60	0.65	0.70

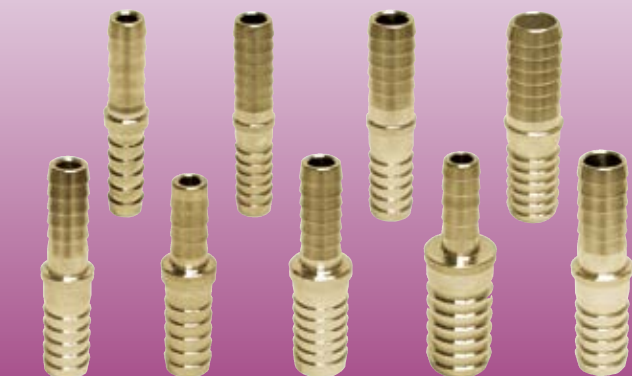

SPLICERS						
Catalog No.	Fits Vinyl Tubing I.D.	Fits Poly Tubing I.D.	100+	50+	25+	Each
05A03-103	3/16" x 3/16"	1/4" x 1/4"	0.95	1.05	1.15	1.25
05A03-104	3/16" x 1/4"	1/4" x 5/16"	0.95	1.05	1.15	1.25
05A03-130	3/16" x 5/16"	1/4" x 3/8"	0.95	1.05	1.15	1.25
05A03-105	3/16" x 3/8"	-	1.00	1.10	1.20	1.30
05A03-106	1/4" x 1/4"	5/16" x 5/16"	1.00	1.10	1.20	1.30
05A03-131	1/4" x 5/16"	5/16" x 3/8"	1.00	1.10	1.20	1.30
05A03-107	1/4" x 3/8"	-	1.00	1.10	1.20	1.30
05A03-135	1/4" x 1/2"	5/16" x 1/2"	1.67	1.77	1.86	2.03
05A03-125	5/16" x 5/16"	3/8" x 3/8"	0.95	1.05	1.15	1.25
05A03-132	5/16" x 3/8"	-	1.00	1.10	1.20	1.30
05A03-133	5/16" x 1/2"	3/8" x 1/2"	1.67	1.77	1.86	2.03
05A03-108	3/8" x 3/8"	-	1.00	1.10	1.20	1.30
05A03-134	3/8" x 1/2"	-	1.78	1.89	1.98	2.16
05A03-126	1/2" x 1/2"	1/2" x 1/2"	1.78	1.89	1.98	2.16

Tail Pieces and Splicers

Armaflex® 6' Foam Tube and Sheet Insulation

MILDEW AND MOLD RESISTANT • GREAT FOR INSULATING SODA/BEER TUBING RUNS



FOAM TUBING IS SOLD IN 6' SECTIONS ONLY - PRICED PER FOOT

Catalog No.	Wall	ID	36'+	18'+	6'+
19D05-108	1/4"	1/2"	0.40	0.42	0.44
19D05-119	3/8"	1/2"	0.40	0.42	0.44
19D05-103	3/8"	5/8"	0.46	0.48	0.51
19D05-104	3/8"	1-5/8"	0.77	0.82	0.86
19D05-113	1/2"	1-1/8"	0.82	0.88	0.92
19D05-111	1/2"	1-5/8"	1.13	1.20	1.26
19D05-101	1/2"	2-1/8"	1.47	1.56	1.64
19D05-102	1/2"	2-5/8"	2.00	2.13	2.23
19D05-105	1/2"	3-1/8"	2.35	2.50	2.62
19D05-110	1/2"	3-1/2"	2.52	2.67	2.80

Catalog No.	Wall	ID	36'+	18'+	6'+
19D05-106	1/2"	4-1/8"	3.40	3.61	3.79
19D05-109	1/2"	4-1/2"	3.74	3.97	4.16
19D05-118	3/4"	1-3/8"	1.82	1.94	2.03
19D05-107	3/4"	1-5/8"	2.46	2.61	2.74
19D05-112	3/4"	2-1/8"	3.03	3.22	3.38
19D05-120	3/4"	2-1/2"	3.27	3.47	3.64
19D05-116	3/4"	2-5/8"	3.82	4.06	4.26
19D05-121	3/4"	3-1/8"	3.78	4.02	4.21
19D05-117	1"	1-5/8"	3.97	4.22	4.43
19D05-115	1"	2-1/8"	4.90	5.20	5.46

SHEET INSULATION 36" X 48" X 1/2" 19D05-200 PER SHEET \$22.57

Additional price breaks available on most items. Login to your website account or contact your sales representative for pricing.

Premium Vinyl Tapes

HIGH QUALITY VINYL TAPE WITH EXCELLENT ADHESION

20D01-106 is great for finishing exterior of insulated tubing bundles. Helps protect insulation and reduces friction when pulling through a chase.

- 2" wide x 100' length per roll



20D01-107 is a cold temperature tape that remains stretchy and pliable even in cold environments and is great for using as a moisture barrier on insulated tubing bundles.

- 2" wide x 100' length per roll



Catalog No.	Size	6+	3+	Ea.
20D01-106	2" Wide Vinyl Tape	4.75	5.00	5.25
20D01-107	2" Wide Cold Temp. Tape	5.00	5.25	5.50

Aluminum Foil Tapes

SUPERIOR ADHESION AND VIRTUALLY NO ODOR

20A01-103 is great for transferring cold from glycol lines to product lines on insulated tubing bundles.

- 2" wide x 150' length per roll



20A01-104 is the same as above and used for the same purpose, but requires fewer turns per foot when wrapping insulated tubing bundles.

- 3" wide x 150' length per roll



Catalog No.	Size	6+	3+	Each
20A01-103	2" Wide Foil Tape	11.69	12.42	13.03
20A01-104	3" Wide Foil Tape	17.01	17.76	18.88

Premium Cloth Duct Tape

HIGH QUALITY TAPE WITH EXCELLENT ADHESION

Tough polyethylene with fabric reinforcement provides superior adhesion and is used for the initial phase of wrapping lines in insulated tubing bundles. It has many other uses as well.

- 2" wide x 180' length per roll



Catalog No.	Size	6+	3+	Each
20D01-100	2" Wide Duct Tape (black)	8.50	8.95	9.50
20D01-101	2" Wide Duct Tape (gray)	7.50	7.95	8.50

Adhesive Foam Insulation Tape

HIGH QUALITY TAPE WITH EXCELLENT ADHESION

Self adhesive, easily molds to irregular surfaces. Insulated and prevents sweating.

- 1/8" thick x 2" wide x 30' length per roll



Catalog No.	24+	12+	Each
20D01-104	6.95	7.50	7.95

Foam Insulation Tubing and Various Tapes

Accuflex Quality Hose and Tubing

THE RECOGNIZED LEADER IN BEVERAGE TRANSFER PRODUCTS

Bevlex® Series 200 CRYSTAL CLEAR VINYL DUAL DUROMETER CONSTRUCTION

- Very flexible • Excellent kink resistance • Taste protection properties • No foam super smooth bore • Phthalate free



APPROVED BY MAJOR BREWERIES

SUPER FLEXIBLE – EVEN WHEN COLD							PRICES PER 100'			PRICE PER FOOT
Catalog No.	Color	I.D.	O.D.	Working Pressure at 70°F	Clamp Index	Roll Size	10 Rolls	5 Rolls	1 Roll	Under 100'
08A05-118	Clear	3/16"	5/16"	60	B	100'	10.75	11.51	12.21	.20
08A05-120	Clear	3/16"	7/16"	80	E	100'	22.93	24.57	26.06	.50
08A05-520	Clear	3/16"	7/16"	80	E	500'	22.05	22.93	24.57	–
08P05-112	Clear	1/4"	3/8"	55	C	100'	12.41	13.30	14.11	.25
08A05-121	Clear	1/4"	1/2"	70	Q	100'	27.55	29.51	31.30	.60
08P05-113	Clear	5/16"	7/16"	45	E	100'	13.79	14.77	15.67	.30
08A05-125	Clear	5/16"	9/16"	60	H	100'	25.32	27.13	28.77	.50
08A05-525	Clear	5/16"	9/16"	60	H	500'	24.35	25.32	27.13	–
08P05-114	Clear	3/8"	1/2"	45	Q	100'	16.40	17.57	18.64	.30
08A05-126	Clear	3/8"	5/8"	50	J	100'	26.13	28.00	29.70	.60
08A05-526	Clear	3/8"	5/8"	50	J	500'	25.13	26.13	28.19	–
08P05-115	Clear	1/2"	5/8"	30	J	100'	21.41	22.94	24.33	.40
08A05-127	Clear	1/2"	3/4"	40	I	100'	42.88	45.94	48.73	.90
08A05-119	Black	3/16"	7/16"	80	E	100'	27.76	29.74	31.55	.60
08A05-141	Black	3/8"	5/8"	50	J	100'	40.03	42.89	45.48	.80
08A05-123	Blue	5/16"	9/16"	60	H	100'	36.45	39.06	41.42	.80
08A05-124	Red	5/16"	9/16"	60	H	100'	37.17	39.83	42.24	.80
08A05-524	Red	5/16"	9/16"	60	H	500'	–	–	39.83	–
TRANSLUCENT COLORED TUBINGS										
08A05-130	Blue	5/16"	9/16"	60	H	100'	39.15	41.94	44.48	.80
08A05-530	Blue	5/16"	9/16"	60	H	500'	–	–	41.94	–
08A05-130	Red	5/16"	9/16"	60	H	100'	39.15	41.94	44.48	.80
08A05-531	Red	5/16"	9/16"	60	H	500'	–	–	41.94	–

Bevlex® Series 222 Thinwall SEMI-TRANSPARENT POLYETHYLENE NON-BARRIER

- Inexpensive • Odorless and tasteless • Kink resistant

ACCEPTABLE FOR BEER LINES						PRICES PER 100'				PRICE PER FOOT
Catalog No.	I.D.	O.D.	Working Pressure at 70° F	Clamp Index	Roll Size	4 Rolls	2 Rolls	1 Roll	100' Section	Under 100'
08H05-115	1/4"	3/8"	125	B	500'	11.36	12.17	12.91	14.69	.25
08H05-116	3/8"	1/2"	100	F	500'	15.75	16.87	17.89	20.36	.40
08H05-117	1/2"	5/8"	75	H	500'	20.75	22.23	23.58	26.83	.50

Bev-Seal Ultra® Series 235 POLYEFIN TUBE WITH INTERNAL DUAL BARRIER

- Prevents flavor permeation • Works well with pungent flavors • Lightweight • Very flexible
- Allows quick flavor changeovers without taste transfer

PREVENTS FLAVOR PERMEATION						PRICES PER 100'				PRICE PER FOOT
Catalog No.	I.D.	O.D.	Working Pressure at 70° F	Clamp Index	Roll Size	4 Rolls	2 Rolls	1 Roll	100' Section	Under 100'
08H05-247	3/16"	5/16"	150	A	1000'	14.75	15.80	16.76	19.07	.35
08H05-249	1/4"	3/8"	125	B	500'	16.71	17.90	18.98	21.60	.40
08H05-248	5/16"	7/16"	100	C	500'	19.95	21.37	22.67	25.79	.50
08H05-250	3/8"	1/2"	100	F	500'	23.09	24.74	26.24	29.86	.60
08H05-251	1/2"	5/8"	75	H	500'	31.75	34.01	36.08	41.05	.70

Restriction by Tubing Type

ADD 1/2 P.S.I. FOR EVERY FOOT OF VERTICAL LIFT AND SUBTRACT 1/2 P.S.I. FOR EVERY FOOT OF VERTICAL DROP

BEVLEX® SERIES 200		
3/16" I.D.	PER FOOT	= 2.2 P.S.I.
1/4" I.D.	PER FOOT	= .80 P.S.I.
5/16" I.D.	PER FOOT	= .40 P.S.I.
3/8" I.D.	PER FOOT	= .20 P.S.I.
1/2" I.D.	PER FOOT	= .00 P.S.I.

BEVLEX® SERIES 222 THINWALL		
3/16" I.D.	PER FOOT	= N/A
1/4" I.D.	PER FOOT	= .60 P.S.I.
5/16" I.D.	PER FOOT	= .20 P.S.I.
3/8" I.D.	PER FOOT	= .07 P.S.I.
1/2" I.D.	PER FOOT	= .00 P.S.I.

BEV-SEAL ULTRA® SERIES 235		
3/16" I.D.	PER FOOT	= 2.0 P.S.I.
1/4" I.D.	PER FOOT	= .30 P.S.I.
5/16" I.D.	PER FOOT	= .10 P.S.I.
3/8" I.D.	PER FOOT	= .06 P.S.I.
1/2" I.D.	PER FOOT	= .00 P.S.I.



Tubing (Beer Related)

Accuflex Quality Hose and Tubing

THE RECOGNIZED LEADER IN BEVERAGE TRANSFER PRODUCTS

140° Fahrenheit is the maximum operating temperature for all items listed

Reinforced Braided Tubing

Bevlex® Series 170 POLYESTER-REINFORCED POLYETHYLENE WITH COPOLYMER JACKET

- Increased pressure performance • Excellent resistance to kinks and stress cracks
- Copolymer jacket is abrasion resistant

APPROVED BY MAJOR BOTTLERS

IDEAL FOR PRODUCT LINES						PRICES PER 100'				PRICE PER FOOT
Catalog No.	I.D.	O.D.	Working Pressure at 70° F	Clamp Index	Roll Size	4 Rolls	2 Rolls	1 Roll	100' Section	Under 100'
08H05-151	1/4"	15/32"	300	C	500'	16.96	18.17	19.27	21.93	.40
08H05-153	1/4"	17/32"	300	F	500'	24.81	26.59	28.20	32.09	.60
08H05-152	3/8"	19/32"	300	G	300'	27.43	29.39	31.17	35.47	.60
08H05-155	1/2"	3/4"	250	K	500'	51.44	55.11	58.45	66.52	1.20



OTHER ACCUFLEX™ HOSES AND TUBINGS AVAILABLE — SEE PAGES 76-80

Glycol Line Tubing

LLDPE Polyethylene Series 221 INDUSTRIAL GRADE POLY TUBING (NOT FOOD GRADE)

- Inexpensive • Odorless and tasteless
- Resistant to kinking, environmental stress cracks, solvents, sunlight and UV radiation

USED FOR GLYCOL RECIRCULATING LINES							PRICES PER 100'				PRICE PER FOOT
Catalog No.	Color	I.D.	O.D.	Working Pressure at 70° F	Clamp Index	Roll Size	4 Rolls	2 Rolls	1 Roll	100' Section	Under 100'
08H05-252	Black	3/8"	1/2"	100	F	500'	15.53	16.64	17.65	20.09	.40
08H05-116	White	3/8"	1/2"	100	F	500'	15.75	16.87	17.89	20.36	.40
08H05-352	Blue	3/8"	1/2"	100	F	500'	19.44	20.83	22.09	25.14	.50
08H05-353	Red	3/8"	1/2"	100	F	500'	19.44	20.83	22.09	25.14	.50



Drain Tubing

Sani-Clean AM™ Series 218 SPECIAL PROPRIETARY COMPOUND

- Antimicrobial additive discourages the development of fungal growth on the inner and outer surface of tubing
- Unique translucent metallic gray color offers a sanitary appearance, while allowing for a visual inspection of the line • Flexible and kink resistant

DISCOURAGES FUNGAL GROWTH						PRICES PER 100'				PRICE PER FOOT
Catalog No.	I.D.	O.D.	Working Pressure at 70° F	Clamp Index	Roll Size	4 Rolls	2 Rolls	1 Roll	100' Section	Under 100'
08H05-401	1/2"	3/4"	45	06K07-101	100'	39.24	42.04	44.59	48.00	.80
08H05-402	5/8"	7/8"	40	06K07-101	100'	50.93	54.57	57.88	62.00	1.00
08H05-403	3/4"	1"	39	06G08-206	100'	56.36	60.39	64.05	68.00	1.20
08H05-113	1"	1-1/4"	25	06G08-206	100'	79.04	84.69	89.82	95.00	1.60



TigerFlex® Series DHG SMOOTH BORE PVD WITH PVD HELIX REINFORCEMENT

- Convoluted construction provides exceptional kink resistance • Has a very tight bend radius for "hard to install" locations • Ideal where kinking or crushing of tube is an issue

MINIMIZES FLOW RESTRICTIONS						PRICES PER 100'				PRICE PER FOOT
Catalog No.	I.D.	O.D.	Working Pressure at 68° F	Clamp Index	Roll Size	4 Rolls	2 Rolls	1 Roll	100' Section	Under 100'
08H05-200	1/2"	11/16"	38	-	100'	78.64	84.26	89.36	95.00	1.60
08H05-201	3/4"	1-1/16"	36	-	100'	78.64	84.26	89.36	95.00	1.60
08H05-202	1"	1-3/8"	36	-	100'	108.91	116.69	123.76	131.00	2.00



Tubing (Beer Related)

NOTE: FITTINGS USED NEED TO BE OVERSIZED AND TUBING STRETCHED TO FIT

Ultra Barrier™ Thinwall Flexible Barrier Tubing

Highly flexible, PVC/BPA-free, food-grade tubing • FDA approved • Superior barrier properties • Ultra low permeation
Proven to have no significant impact on taste or flavor • Environmentally friendly production - does not emit toxins



SYPHON OR RACKING TUBING							PRICES PER 100'			PRICE PER FOOT
Catalog No.	I.D.	O.D.	Wall	Working Pressure at 70° F	Clamp No.	Roll Size	4 Rolls	2 Rolls	1 Roll	Under 100'
08F01-100	3/16"	5/16"	1/16"	53 psi	06G08-205	100'	56.67	60.72	64.40	.87
08F01-103	1/4"	3/8"	1/16"	39 psi	06G08-184	100'	60.67	65.00	68.94	.95
08F01-106	5/16"	7/16"	1/16"	34 psi	06G08-185	100'	71.33	76.43	81.06	1.10
08F01-110	3/8"	1/2"	1/16"	33 psi	06G08-192	100'	78.12	83.71	88.78	1.20
08F01-113	1/2"	5/8"	1/16"	22 psi	06G08-194	100'	87.89	94.16	99.87	1.35

Ultra Barrier™ Flexible Barrier Tubing

Highly flexible, PVC/BPA-free, food-grade tubing • FDA approved • Superior barrier properties • Ultra low permeation
Proven to have no significant impact on taste or flavor • Environmentally friendly production - does not emit toxins



STANDARD BEER LINE							PRICES PER 100'			PRICE PER FOOT
Catalog No.	I.D.	O.D.	Wall	Working Pressure at 70° F	Clamp No.	Roll Size	4 Rolls	2 Rolls	1 Roll	Under 100'
08F01-101	3/16"	7/16"	1/8"	85 psi	06G08-185	100'	68.45	73.33	77.78	1.05
08F01-104	1/4"	1/2"	1/8"	59 psi	06G08-192	100'	73.27	78.51	83.26	1.10
08F01-107	5/16"	9/16"	1/8"	59 psi	06G08-183	100'	86.13	92.28	97.87	1.30
08F01-111	3/8"	5/8"	1/8"	53 psi	06G08-194	100'	94.35	101.09	107.21	1.42
08F01-114	1/2"	3/4"	1/8"	40 psi	06K07-101	100'	106.14	113.72	120.61	1.65

Ultra Barrier™ Silver™ Flexible Barrier Tubing with Antimicrobial Lining

Highly flexible, PVC/BPA-free, food-grade tubing • FDA approved • Superior barrier properties • Ultra low permeation
Proven to have no significant impact on taste or flavor • 100% effective against the top 4 beverage spoiling bacteria



STANDARD BEER LINE - WHEN BACTERIA & BIOFILM IS A CONCERN							PRICES PER 100'			PRICE PER FOOT
Catalog No.	I.D.	O.D.	Wall	Working Pressure at 70° F	Clamp No.	Roll Size	4 Rolls	2 Rolls	1 Roll	Under 100'
08F01-102	3/16"	7/16"	1/8"	85 psi	06G08-185	100'	88.23	94.54	100.27	1.35
08F01-105	1/4"	1/2"	1/8"	59 psi	06G08-192	100'	94.45	101.19	107.32	1.45
08F01-109	5/16"	9/16"	1/8"	59 psi	06G08-183	100'	111.02	118.95	126.16	1.70
08F01-112	3/8"	5/8"	1/8"	53 psi	06G08-194	100'	121.61	130.30	138.19	1.90
08F01-115	1/2"	3/4"	1/8"	40 psi	06K07-101	100'	136.81	146.58	155.46	2.10

Beverage High Temp™ Silicone-Free Flexible Barrier Tubing

Highly flexible, PVC/BPA-free, food-grade tubing • Superior barrier properties • For use up to 275° Fahrenheit
Proven to have no significant impact on taste or flavor • Environmentally friendly production - does not emit toxins



HIGH TEMPERATURE 275°F - FOR HOT FLUID TRANSFER							PRICES PER 100'			PRICE PER FOOT
Catalog No.	I.D.	O.D.	Wall	Working Pressure at 70° F	Clamp No.	Roll Size	4 Rolls	2 Rolls	1 Roll	Under 100'
08F01-116	3/8"	5/8"	1/8"	30 psi	06G08-194	50'	148.40	152.47	159.00	2.25
08F01-117	1/2"	3/4"	1/8"	27 psi	06K07-101	50'	156.36	160.64	178.94	2.70

Ultra Barrier Gas™ Gas Line Tubing

Tubing with a red stripe • Perfect for CO₂, Nitrogen or blended gas lines up to 60 psi • Same features as Ultra Barrier



LOW PRESSURE GAS LINE - WITH A RED STRIPE IDENTIFIER							PRICES PER 100'			PRICE PER FOOT
Catalog No.	I.D.	O.D.	Wall	Working Pressure at 70° F	Clamp No.	Roll Size	4 Rolls	2 Rolls	1 Roll	Under 100'
08F01-108	5/16"	9/16"	1/8"	60 psi	06G08-183	100'	86.13	92.28	97.87	1.35

EJ Beverage Ultra Barrier Tubings

HOW TO ORDER CLAMPS AND FERRULES

In general: Fitting a clamp or ferrule over hose is similar to fitting a ring on your finger. There should be sufficient "play" to get ferrule/clamp off and on. Other sizes available upon request.

For smaller than 5/8" O.D. hose: Rule of thumb next size larger for ferrule and clamp.

For larger than 5/8" O.D. hose: Normally there is sufficient "play" built into clamp or ferrule to allow for clamp and ferrule to fit properly when same size is ordered. **NOTE:** All clamps priced per 100.

Oetiker No.	Nominal Size	Clamp Index	Catalog No.	500 +	300 +	100 +	Each
8.0	5/16"		06G08-187	12.86	13.24	13.64	.25
8.7	11/32"	A	06G08-188	12.86	13.24	13.64	.25
9.5	3/8"		06G08-189	12.86	13.24	13.64	.25
10.0	25/64"		06G08-198	12.86	13.24	13.64	.25
10.5	13/32"	B	06G08-205	12.86	13.24	13.64	.25
11.3	7/16"	D	06G08-190	12.86	13.24	13.64	.25
12.3	15/32"	C	06G08-184	12.86	13.24	13.64	.25
12.8	31/64"		06G08-181	12.86	13.24	13.64	.25
13.3	1/2"	E	06G08-185	12.86	13.24	13.64	.25
14.0	35/64"	F	06G08-191	12.86	13.24	13.64	.25
14.5	9/16"	Q	06G08-192	12.86	13.24	13.64	.25
15.7	5/8"	G	06G08-193	12.86	13.24	13.64	.25
16.2	21/32"	M	06G08-203	12.86	13.24	13.64	.25
17.0	11/16"	H	06G08-183	12.86	13.24	13.64	.25
18.5	23/32"	J	06G08-194	12.86	13.24	13.64	.25
19.8	3/4"	K	06G08-195	12.86	13.24	13.64	.25
21.0	13/16"	I	06G08-201	12.86	13.24	13.64	.25
22.6	7/8"	L	06G08-196	12.86	13.24	13.64	.25
25.6	1"		06G08-202	15.09	15.53	16.00	.35
27.1	1-1/16"		06G08-199	12.86	13.24	13.64	.25
28.6	1-1/8"	P	06G08-200	12.86	13.24	13.64	.25
30.1	1-3/16"		06G08-197	12.86	13.24	13.64	.25

Stainless Steel Stepless Clamps

- Manufactured of 304 grade stainless steel for extended durability and increased corrosion resistance
- Stepless® tongue-in-groove design provides uniform pressure and a leak-free seal
- All Oetiker® clamps have burr-free edges to protect parts and to prevent injury
- The clamp ears adjustable crimp range compensates for component tolerances and applied pressure



Adjustable Worm-Gear Clamps – 300 Series Stainless Steel

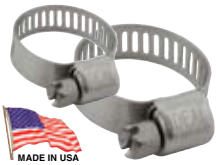

A LONG TRUSTED LEADING MANUFACTURER OF WORM-GEAR CLAMPS
Burr-free edges • Durable • Strong

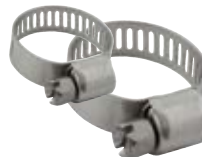

A HIGH QUALITY IMPORT OFFERING AN ALTERNATIVE TO MORE EXPENSIVE CLAMPS
Burr-free edges • Durable • Strong

Catalog No.	Adjustable Size Range	500+	300+	100+	Each
06K07-103	1/4"–5/8"	0.40	0.43	0.45	0.55
06K07-101	3/8"–7/8"	0.42	0.44	0.46	0.57

Catalog No.	Adjustable Size Range	500+	300+	100+	Each
06E07-203	1/4"–5/8"	0.21	0.22	0.25	0.35
06E07-201	3/8"–7/8"	0.22	0.23	0.25	0.35

Additional price breaks available on most items. Login to your website account or contact your sales representative for pricing.

Beer Service Kit

DESIGNED FOR BEER SERVICE PERSONNEL

A generous assortment of common replacement parts for faucets, compression shanks, keg couplers.

KIT INCLUDES:

FAUCET REPLACEMENT PARTS

100 pc Faucet Washers • 50 pc Friction Rings
50 pc Friction Ring Washers • Plunger Seats

COMPRESSION SHANK REPLACEMENT PARTS

25 pc Grommets • 5 pc Goosenecks • 5 pc Compression Nut

SANKE KEG COUPLERS REPLACEMENT PARTS

100 pc Beer Washers • 25 pc Bottom Seals • 10 pc Probe Seals

12D03-135

5+ **\$94.95**

2+ \$96.95 Ea. \$99.95



Oetiker® Stepless® Clamp Kit

DESIGNED FOR SERVICE PERSONNEL

A generous assortment of commonly used clamps and one of Oetiker's side jaw pincers.

KIT INCLUDES:

25 pc each of Stepless Clamps

11/32", 13/32", 15/32", 1/2"
35/64", 9/16", 5/8", 11/16", 23/32"

1 pc each of Accessories

Metal Parts Box (adjustable dividers)
Oetiker Side Jaw Pincers



06D03-196

5+ **\$64.95**

2+ \$67.95 Ea. \$70.95

Clamps and Service Kits

Professional Hose and Tubing Cutter

HEAVY-DUTY CONSTRUCTION • CUTS FROM 1/4" TO OVER 1" DIAMETER

SPECIAL V-BLOCK DESIGN ENSURES A STRAIGHT, CLEAN CUT EVERY TIME

20L02-120



- Two cutting surfaces on every blade
Simply rotate blade to expose the new surface
- Easy to use...weighs approximately 12 ounces
- No more jagged or angled cuts
- So strong it even cuts kevlar lined hose

REPLACEMENT
BLADE
(DUAL EDGE)



20L02-121



12+ **\$22.95** 6+ \$23.95 3+ \$24.95 Ea. \$26.95

12+ **\$5.00** 6+ \$5.25
3+ \$5.50 Ea. \$5.75

Spear-Point Tubing Cutter

IDEAL FOR CUTTING: Vinyl, Polyethylene, Silicone, braided, barrier, etc.



20K02-101 50+ **\$2.35**
25+ \$2.45 10+ \$2.55 Ea. \$2.95

Replacement Blade 20K02-102
25+ **\$1.35** 10+ \$1.45 Ea. \$1.65

CUTS 1/8" OD to 3/4" OD TUBINGS OR HOSES

- Designed to provide a clean, square cut
- Design helps eliminate "smashing" or "deforming"
- 3" overall length – Spring loaded to close position

Additional price breaks available on most items. Login to your website account or contact your sales representative for pricing.

KwikCut™ Professional Tubing and Hose Cutters

MODEL 100
Cuts up to 1" dia.



MODEL 100-OT
Cuts up to 1" dia.



SPRING
LOADED

MODEL 200
Cuts up to 2" dia.



Catalog No.	Description	10+	5+	Each
20L02-103	Cutter (Model 100)	12.95	13.95	14.95
20L02-104	Blade only (Model 100)	4.73	5.08	5.40

Catalog No.	Description	10+	5+	Each
20L02-105	Cutter (Model 100-OT)	15.95	16.95	17.95
20L02-104	Blade only (Model 100)	4.73	5.08	5.40

Catalog No.	Description	10+	5+	Each
20L02-107	Cutter (Model 200)	15.95	16.95	17.95
20L02-108	Blade only (Model 200)	5.88	6.22	6.70

Tubing
Cutters

Spear-Point Tubing Cutter

IDEAL FOR CUTTING: Vinyl, Polyethylene, Silicone, braided, barrier, etc.



20L02-101

50+ **\$7.50** 25+ \$7.95 10+ \$8.50 Ea. \$8.95

REPLACEMENT BLADE

20L02-102

25+ **\$1.80** 10+ \$1.90 Ea. \$2.00



CUTS 1/8" OD to 3/4" OD TUBINGS OR HOSES

- Designed to provide a clean, square cut
- Design helps eliminate "smashing" or "deforming"
- 3" overall length – Spring loaded to close position



Oetiker® Compound Action Clamp Pincers

PROFESSIONAL QUALITY • EXTREMELY DURABLE • REQUIRES ABOUT HALF THE FORCE VS OTHER STYLE

NEW & IMPROVED

Redesigned to reduce the amount of hand span required to pinch clamp



STANDARD JAW

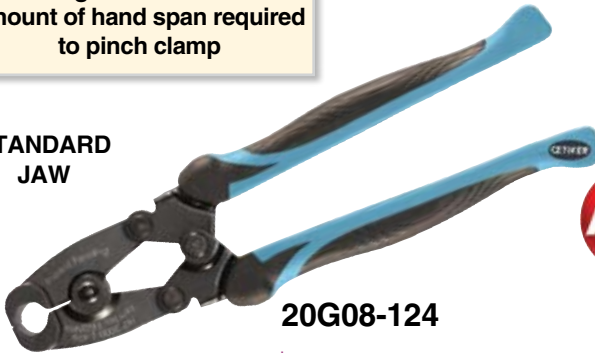

20G08-124

20+ **\$27.95**

10+ \$29.95 5+ \$30.95 Ea. \$31.95



SIDE JAW



20G08-125

20+ **\$28.95**

10+ \$29.95 5+ \$30.95 Ea. \$32.95

Single Action Clamp Pincers



STANDARD JAW



20G08-120

10+ **\$14.95**

5+ \$15.95 Ea. \$16.95



SIDE JAW



20G08-119

10+ **\$20.95**

5+ \$21.95 Ea. \$22.95

Standard Jaw Pincers



RUGGED AND DEPENDABLE



20K08-100

12+ **\$6.50**

6+ \$6.95 Ea. \$7.50

Pinch-Off Tubing Tool

TEMPORARILY SHUTS OFF BEVERAGE FLOW



- Rounded jaws prevent plastic tubing damage
- Allows service work to be performed without shutting down the system

20R09-120

25+ **\$17.95**

10+ \$18.50 5+ \$18.95 Ea. \$19.95

Oetiker® Clamp Cutters

SPECIFICALLY DESIGNED FOR REMOVING CLAMPS

NEW & IMPROVED

Redesigned to reduce the amount of hand span required to pinch clamp



20G08-118

20+ **\$38.95**

10+ \$40.95 5+ \$41.95 Ea. \$44.95

Clamp Pincers, Cutter and Pinch-Off Tool



DISPENSE REGULATOR™

PERFECTLY POURED BEERS EVERY TIME!

**Minimize beer waste & Maximize profits
Save time on installation and service calls**

SHORT DRAW • LONG DRAW • KEGS IN A SERIES

INTRODUCING THE 1st TRULY INNOVATIVE SECONDARY REGULATOR

- Sleek inline design attaches directly to the gas port of any style of keg coupler
- Dramatically decreases installation time compared to other types of secondary regulators
- Based on proven medical technology, the DISPENSE REGULATOR™ provides high precision and lasting durability
- Greatly reduces chances for leaks and can be leak tested under water
- Preset output pressure at 12 PSI but can easily be adjusted to any PSI from 4-55 PSI

ACCURATE TO

± .5 PSI

PRESSURE ADJUSTMENT

COMPATIBLE WITH: CO₂, N₂, GAS BLENDS, ARGON, O₂, N₂O

BEER • SODA • WINE • COFFEE • KOMBUCHA

03L02-100

48+ \$20.95

24+ \$21.95

12+ \$22.95

6+ \$23.95

Ea. \$25.95

Pressure Adjustment Tool

INSURES NO MORE OVER PRESSURIZED BEER KEGS DUE TO UNAUTHORIZED ADJUSTMENTS



**Buy 48 pc of the
ITW DISPENSE
REGULATORS**

**Get 1 pc of the
ADJUSTMENT TOOL**

FREE

Installer Adjustment Tool

Used to adjust preset 12 PSI to another pressure setting

- Quickly set ITW Dispenser Regulator to the exact desired pressure
- Rugged, durable and easy-to-use
- Accurate to ± 0.5 PSI
- Adjustable from 4-55 PSI

03L02-110

12+ \$35.95

6+ \$37.95

Ea. \$39.95





0-15 PSI Secondary TruRegs™

HIGHER FLOW RATES • HIGHER PERFORMANCE • GREATER ACCURACY • GREATER SENSITIVITY
DEPENDABLE AND RELIABLE • EXCEPTIONALLY LOW PRESSURE LOSS IN SERIES • EASY SERVICE



Catalog No.	Number of Regs.	Description	24+	12+	6+	Each
03M03-101	1	0-15 PSI, 1/4" MFL In/Out, 3/8" Barb Shutoff	66.95	69.95	71.95	74.95
03M03-102	2	0-15 PSI, 1/4" MFL In/Out, 3/8" Barb Shutoff	116.95	121.95	124.95	129.95
03M03-103	3	0-15 PSI, 1/4" MFL In/Out, 3/8" Barb Shutoff	167.95	173.95	178.95	186.95
03M03-104	4	0-15 PSI, 1/4" MFL In/Out, 3/8" Barb Shutoff	217.95	226.95	232.95	242.95

**Have a balanced draught system
and still having **POURING PROBLEMS?**
We designed a solution.**



0-60 PSI Secondary TruRegs™



Catalog No.	Number of Regs.	Description	24+	12+	6+	Each
03M03-111	1	0-60 PSI, 1/4" MFL In/Out, 3/8" Barb Shutoff	66.95	69.95	71.95	74.95
03M03-112	2	0-60 PSI, 1/4" MFL In/Out, 3/8" Barb Shutoff	116.95	121.95	124.95	129.95
03M03-113	3	0-60 PSI, 1/4" MFL In/Out, 3/8" Barb Shutoff	167.95	173.95	178.95	186.95
03M03-114	4	0-60 PSI, 1/4" MFL In/Out, 3/8" Barb Shutoff	217.95	226.95	232.95	242.95

McDantim TruRegs™ Secondary Regulators

TAPRITE Primary CO₂ Regulators

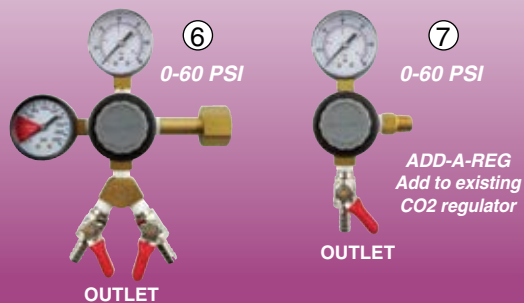
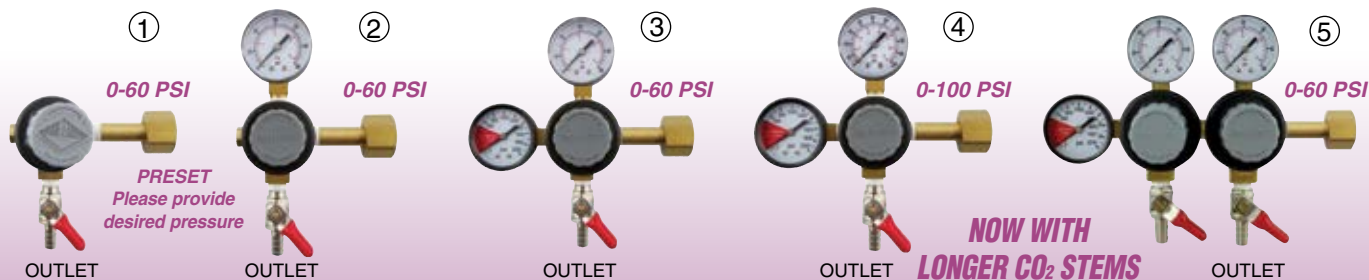

SELECT FROM AVAILABLE OUTLETS

ALL OUTLETS ✓

HAVE A CHECK VALVE

A 1/4" MFL
Select Regulator then select Outlet

B 1/4" MFL

C 1/4" BARB

D 5/16" BARB

TAPRITE Secondary and Nitrogen Regulators

NOT FINDING WHAT YOU ARE LOOKING FOR?

Foxx Equipment can build a regulator to meet your exact needs. Call your sales representative for affordable pricing.

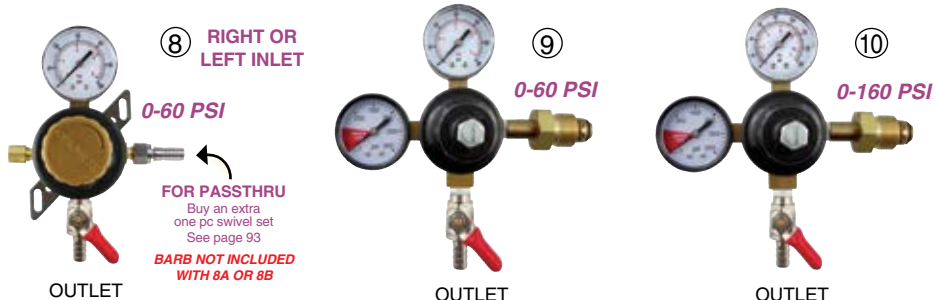

Taprite Beer Regulators

Ref. #	Catalog No.	Gauge	24+	12+	6+	Each
1A	03C09-100	N/A	36.95	37.95	39.95	40.95
1B	03C09-101	N/A	39.95	40.95	42.95	43.95
1C	03C09-108	N/A	39.95	40.95	42.95	44.95
1D	03C09-111	N/A	39.95	40.95	42.95	44.95
2A	03C09-109	60 lb.	38.95	39.95	41.95	43.95
2B	03C09-123	60 lb.	41.95	42.95	44.95	46.95
2C	03C09-118	60 lb.	41.95	42.95	44.95	46.95
2D	03C09-104	60 lb.	41.95	42.95	44.95	46.95
3A	03C09-110	60 lb.	40.95	41.95	43.95	45.95
3B	03C09-124	60 lb.	43.95	44.95	46.95	48.95
3C	03C09-116	60 lb.	43.95	44.95	46.95	48.95
3D	03C09-102	60 lb.	43.95	44.95	46.95	48.95
4A	03C09-125	100 lb.	37.95	38.95	40.95	42.95
4B	03C09-126	100 lb.	40.95	41.95	43.95	45.95
4C	03C09-127	100 lb.	40.95	41.95	43.95	45.95
4D	03C09-113	100 lb.	40.95	41.95	43.95	45.95
5A	03C09-128	60 lb.	73.95	76.95	78.95	81.95
5B	03C09-129	60 lb.	79.95	82.95	84.95	88.95
5C	03C09-201	60 lb.	79.95	82.95	85.95	88.95
5D	03C09-200	60 lb.	79.95	82.95	85.95	88.95

Outlet (w/Check Valve)
1/4" MFL
1/4" MFL Shutoff
1/4" Barb Shutoff
5/16" Barb Shutoff
1/4" MFL
1/4" MFL Shutoff
1/4" Barb Shutoff
5/16" Barb Shutoff
1/4" MFL
1/4" MFL Shutoff
1/4" Barb Shutoff
5/16" Barb Shutoff
1/4" MFL
1/4" MFL Shutoff
1/4" Barb Shutoff
5/16" Barb Shutoff

Ref. #	Catalog No.	Gauge	24+	12+	6+	Each
6A	03C09-130	60 lb.	43.95	44.95	46.95	48.95
6B	03C09-131	60 lb.	49.95	50.95	53.95	55.95
6C	03C09-132	60 lb.	50.95	51.95	53.95	55.95
6D	03C09-202	60 lb.	50.95	51.95	53.95	56.95
7A	03C09-133	60 lb.	36.95	37.95	39.95	40.95
7B	03C09-134	60 lb.	39.95	40.95	41.95	44.95
7C	03C09-135	60 lb.	39.95	40.95	42.95	44.95
7D	03C09-204	60 lb.	39.95	40.95	42.95	44.95
8A	03C09-136	60 lb.	35.95	36.95	37.95	39.95
8B	03C09-137	60 lb.	38.95	39.95	40.95	42.95
8C	03C09-138	60 lb.	39.95	40.95	41.95	43.95
8D	03C09-400	60 lb.	39.95	40.95	42.95	44.95
9A	03D03-114	60 lb.	43.95	44.95	46.95	48.95
9B	03J06-127	60 lb.	46.95	47.95	49.95	52.95
9C	03J06-128	60 lb.	46.95	48.95	50.95	52.95
9D	03C09-115	60 lb.	46.95	47.95	50.95	51.95
10A	03C09-119	160 lb.	42.95	43.95	45.95	47.95
10B	03J06-130	160 lb.	45.95	47.95	49.95	51.95
10C	03J06-131	160 lb.	46.95	47.95	49.95	51.95
10D	03C09-114	160 lb.	46.95	47.95	49.95	51.95





Primary CO₂ Regulators

①

0-60 PSI

PRESET
Please provide desired pressure

OUTLET

②

0-60 PSI

OUTLET

③

0-60 PSI

OUTLET

④

0-100 PSI

OUTLET

⑤

0-60 PSI

OUTLET

NOW WITH LONGER CO₂ STEMS

⑥

0-60 PSI

OUTLET

⑦

0-60 PSI

ADD-A-REG
Add to existing CO₂ regulator

OUTLET

SELECT FROM AVAILABLE OUTLETS

ALL OUTLETS ✓ **HAVE A CHECK VALVE**

Ⓐ



1/4" MFL

Ⓑ



1/4" MFL

Ⓒ



1/4" BARB

Ⓓ



5/16" BARB

Select Regulator then select Outlet



Secondary and Nitrogen Regulators

⑧

RIGHT OR LEFT INLET

0-60 PSI

FOR PASSTHRU
Buy an extra one pc swivel set See page 93
BARB NOT INCLUDED WITH 8A OR 8B

OUTLET

⑨

0-60 PSI

OUTLET

⑩

0-100 PSI

OUTLET

NOT FINDING WHAT YOU ARE LOOKING FOR?

Foxx Equipment can build a regulator to meet your exact needs. Call your sales representative for affordable pricing.

Ref. #	Catalog No.	Gauge	24+	12+	6+	Each
1A	03D03-255	N/A	35.95	36.95	37.95	39.95
1B	03D03-256	N/A	38.95	39.95	40.95	42.95
1C	03D03-257	N/A	38.95	39.95	41.95	42.95
1D	03D03-200	N/A	38.95	39.95	41.95	42.95
2A	03D03-205	60 lb.	37.95	38.95	39.95	41.95
2B	03D03-258	60 lb.	40.95	41.95	42.95	44.95
2C	03D03-211	60 lb.	40.95	41.95	43.95	45.95
2D	03D03-201	60 lb.	40.95	41.95	43.95	45.95
3A	03D03-204	60 lb.	38.95	39.95	41.95	43.95
3B	03D03-259	60 lb.	41.95	42.95	44.95	46.95
3C	03D03-212	60 lb.	42.95	43.95	45.95	47.95
3D	03D03-202	60 lb.	42.95	43.95	45.95	47.95
4A	03D03-170	100 lb.	40.95	42.95	43.95	45.95
4B	03D03-176	100 lb.	43.95	45.95	46.95	49.95
4C	03D03-177	100 lb.	44.95	45.95	47.95	49.95
4D	03D03-276	100 lb.	44.95	45.95	47.95	49.95
5A	03D03-260	60 lb.	70.95	73.95	75.95	78.95
5B	03D03-261	60 lb.	76.95	79.95	81.95	85.95
5C	03D03-209	60 lb.	76.95	79.95	82.95	85.95
5D	03D03-208	60 lb.	76.95	80.95	82.95	85.95

Outlet (w/Check Valve)
1/4" MFL
1/4" MFL Shutoff
1/4" Barb Shutoff
5/16" Barb Shutoff
1/4" MFL
1/4" MFL Shutoff
1/4" Barb Shutoff
5/16" Barb Shutoff
1/4" MFL
1/4" MFL Shutoff
1/4" Barb Shutoff
5/16" Barb Shutoff
1/4" MFL
1/4" MFL Shutoff
1/4" Barb Shutoff
5/16" Barb Shutoff

Ref. #	Catalog No.	Gauge	24+	12+	6+	Each
6A	03D03-262	60 lb.	42.95	43.95	45.95	47.95
6B	03D03-263	60 lb.	48.95	49.95	51.95	53.95
6C	03D03-264	60 lb.	48.95	49.95	52.95	54.95
6D	03D03-210	60 lb.	48.95	49.95	52.95	54.95
7A	03D03-265	60 lb.	34.95	35.95	37.95	39.95
7B	03D03-268	60 lb.	37.95	38.95	40.95	42.95
7C	03D03-269	60 lb.	38.95	39.95	40.95	42.95
7D	03D03-278	60 lb.	38.95	39.95	40.95	42.95
8A	03D03-270	60 lb.	37.95	38.95	40.95	41.95
8B	03D03-271	60 lb.	40.95	41.95	43.95	45.95
8C	03D03-272	60 lb.	41.95	42.95	44.95	46.95
8D	03D03-207	60 lb.	41.95	42.95	44.95	46.95
9A	03D03-168	60 lb.	39.95	41.95	42.95	44.95
9B	03D03-222	60 lb.	42.95	44.95	45.95	47.95
9C	03D03-223	60 lb.	43.95	44.95	46.95	48.95
9D	03D03-169	60 lb.	43.95	44.95	46.95	48.95
10A	03D03-266	100 lb.	41.95	43.95	44.95	46.95
10B	03D03-225	100 lb.	44.95	46.95	48.95	50.95
10C	03D03-226	100 lb.	45.95	46.95	48.95	50.95
10D	03D03-267	100 lb.	45.95	46.95	48.95	50.95

TAPRITE Economy CO₂ Beer Regulator

HIGHLY DURABLE • CORROSION RESISTANT • DEPENDABLE

**WORKING
PRESSURE
0-60 PSI**

GAUGES
0-60 PSI
AND
0-2000 PSI

5/16" Barb
WITH
CHECK
VALVE

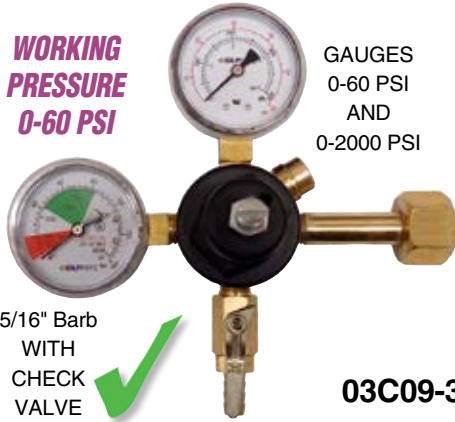

The Economy Series CO₂ Beer Regulator is easy to use and to maintain. The set screw adjustment makes it a "set and forget" tool for maintaining constant pressure into your system. The regulator's zinc bonnet and brass body and fittings help to minimize the chance for freeze-ups during peak usage while also making it corrosion resistant and highly durable in a number of environments.

03C09-300 24+ **\$39.95** 12+ \$40.95 6+ \$42.95 Ea. \$43.95

Universal Gauge Protectors



TAPRITE



Cornelius



NORGREN



**HEAVY DUTY
FITS MOST
BRANDS**

Economy

FITS ALL THREE BRANDS SHOWN AND SOME OTHERS AS WELL

03E01-101

24+ **\$6.95** 12+ \$7.50 6+ \$7.95 Ea. \$8.95

24+ **\$12.95** 12+ \$13.95
6+ \$14.95 Ea. \$15.95

FOR REPLACEMENT GAUGES AND ADDITIONAL REGULATOR COMPONENTS -- SEE PAGE 61

Regulator Internal Repair Kits



Economy



TAPRITE

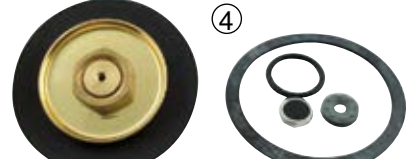

Cornelius

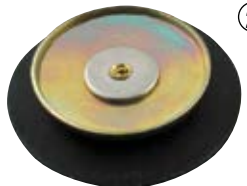

INLET WASHER ONLY

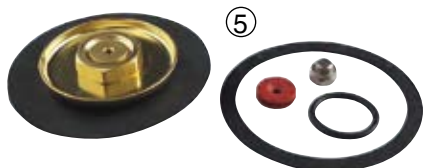

Ref. #	Catalog No.	Description	24+	12+	6+	Each
1	03D03-140	Economy Kit (round)	4.70	4.95	5.50	5.95
2	03D03-303	Economy Kit (hex)	5.85	6.10	6.45	6.80
3	03C09-112	Taprite Kit (all models)	11.13	11.62	12.34	12.95

Ref. #	Catalog No.	Description	24+	12+	6+	Each
3a	06C09-101	Taprite (inlet washer)	0.35	0.37	0.39	0.47
4	03C07-113	Cornelius (secondary)	11.21	11.83	12.53	13.31
5	03C07-216	Cornelius (primary)	10.35	10.92	11.39	12.29



Save Time and Money on Installs with Foxx's Preassembled Panels

***** ALL NEW DESIGN ON ALL PANELS *****

- Can easily attach incoming gas line to either the left or right side of regulator gang
- Can make panel a stand-alone unit or a pass-thru and gang additional panels together
- Where applicable, all FOXX built panels now come with all stainless steel liquid contact

Multi-Reg Secondary Panels *WITHOUT* Wall Brackets

ALL PANELS LISTED ARE BUILT WITH TAPRITE® REGULATOR BODIES – OTHER BRANDS AVAILABLE UPON REQUEST

Catalog No.	No. of Regulators	6+	3+	Each
03D03-282	2 Regulators	93.95	95.95	99.95
03D03-283	3 Regulators	137.95	141.95	147.95
03D03-284	4 Regulators	182.95	187.95	195.95



3/8" BARBED SHUTOFFS WITH BACK-CHECK VALVES

Multi-Reg Secondary Panels *WITH* Wall Brackets

ALL PANELS LISTED ARE BUILT WITH TAPRITE® REGULATOR BODIES – OTHER BRANDS AVAILABLE UPON REQUEST

Catalog No.	No. of Regulators	6+	3+	Each
03D03-279	2 Regulators	103.95	106.95	111.95
03D03-280	3 Regulators	153.95	157.95	164.95
03D03-281	4 Regulators	204.95	209.95	218.95

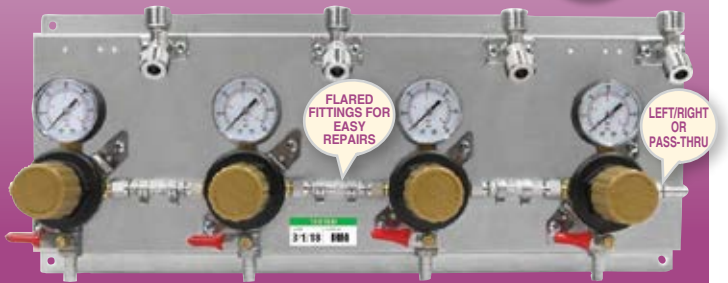

304 STAINLESS STEEL LIQUID CONTACT

Not seeing the configuration you want? Contact your sales representative for pricing and availability on what you do want.

Multi-Reg Secondary Panels

WITH Wall Brackets & Tubing Kits

3/8" BARBED SHUTOFFS WITH BACK-CHECK VALVES

6' LENGTH BEER AND GAS LINES

304 STAINLESS STEEL LIQUID CONTACT



PANELS WITH TAPRITE® REGULATORS				
Catalog No.	No. of Regulators	6+	3+	Each
03D03-320	2 Regulators	121.95	124.95	130.95
03D03-321	3 Regulators	180.95	185.95	193.95
03D03-322	4 Regulators	239.95	246.95	256.95

Preassembled Secondary Regulator Panels

Multi-Reg Secondary Panels WITH Foam Preventers and Tubing Kits

*** ALL NEW DESIGN ON ALL PANELS ***

- Can easily attach incoming gas line to either the left or right side of the regulator gang
- Can make panel a stand-alone unit or a pass-thru and gang additional panels together
- Where applicable, all FOXX built panels now come with all stainless steel liquid contact

ALL PANELS LISTED ARE BUILT WITH TAPRITE® REGULATOR BODIES – OTHER BRANDS AVAILABLE UPON REQUEST



Preassembled Secondary Regulator Panels

Catalog No.	No. of Regulators	6+	3+	Each
03D03-340	2 Regulators	204.95	209.95	218.95
03D03-341	3 Regulators	302.95	310.95	324.95

Catalog No.	No. of Regulators	6+	3+	Each
03D03-342	4 Regulators	402.95	413.95	431.95

Stainless Steel FOB Upgrade

TELL YOUR SALES REP YOU WANT TO UPGRADE

UPGRADE YOUR PANEL TO CORE® FOB
\$65.00 EACH

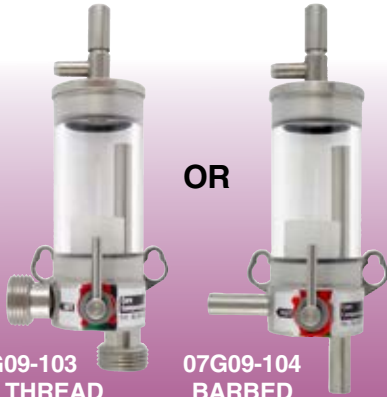

CORE COMPONENTS LIMITED

FOB Overflow Bottle

HELPS KEEP WALK-IN FLOORS CLEAN AND BEER-FREE



HANG FOB OVERFLOW BOTTLE NEXT TO FOB PANEL AND RUN THE DRAIN LINE INTO THE BOTTLE. AS FOBS ARE RESET, THE OVERFLOW WILL DRAIN INTO THE 32 OZ. BOTTLE. WHEN BOTTLE IS FULL, REMOVE IT FROM THE HANGER, EMPTY AND REPLACE.

07D03-110

12+ \$17.95 6+ \$18.95 Ea. \$19.95

Secondary Regulator/Air Distributor Panels

WITH Wall Brackets & Tubing Kits

WITH Foam Preventers & Tubing Kits



304 S/S AND PLASTIC LIQUID CONTACT

6' length gas and beer lines.
Line ends finished with beer nuts and stainless steel tail pieces.

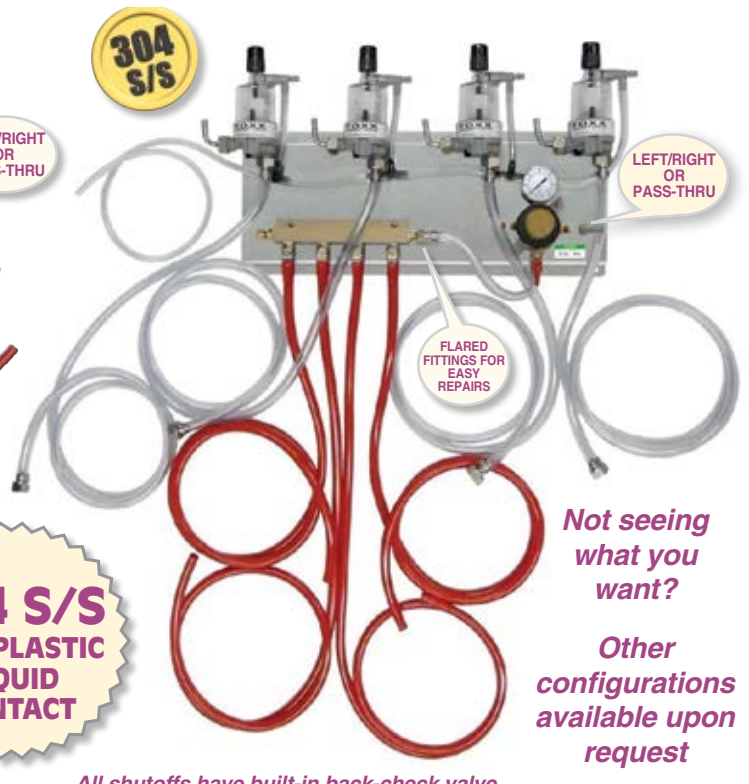

Not seeing what you want?
Other configurations available upon request

All shutoffs have built-in back-check valve

WITH TAPRITE® REGULATOR AND STAINLESS STEEL WALL BRACKETS

Catalog No.	No. of Air Distributor Outlets	6+	3+	Each
03D03-360	2-Outlet Air Distributor	89.95	92.95	96.95
03D03-361	3-Outlet Air Distributor	130.95	134.95	140.95
03D03-362	4-Outlet Air Distributor	153.95	157.95	164.95
03D03-363	5-Outlet Air Distributor	179.95	184.95	191.95
03D03-364	6-Outlet Air Distributor	203.95	208.95	217.95

WITH TAPRITE® REGULATOR AND PACIFIC BEER® FOAM PREVENTERS

Catalog No.	No. of Air Distributor Outlets	6+	3+	Each
03D03-380	2-Outlet Air Distributor	161.95	165.95	172.95
03D03-381	3-Outlet Air Distributor	239.95	245.95	256.95
03D03-382	4-Outlet Air Distributor	299.95	307.95	321.95
03D03-383	5-Outlet Air Distributor	361.95	371.95	387.95
03D03-384	6-Outlet Air Distributor	422.95	433.95	452.95

FOB Overflow Bottle

WALL MOUNTABLE STAINLESS OVERFLOW BOTTLE ASSEMBLY HELPS KEEP WALK-IN FLOORS CLEAN AND BEER-FREE



HANG FOB OVERFLOW BOTTLE NEXT TO FOB PANEL AND RUN THE DRAIN LINE INTO THE BOTTLE. AS FOBS ARE RESET, THE OVERFLOW WILL DRAIN INTO THE 32 OZ. BOTTLE. WHEN BOTTLE IS FULL, REMOVE IT FROM THE HANGER, EMPTY AND REPLACE.

07D03-110
12+ \$17.95
6+ \$18.95 Ea. \$19.95

SELF-DRILLING S/S PANEL SCREWS
05T07-102 5/8" length 0.20¢
05T07-103 1" length 0.23¢

Gas Blender Switchboards

QUICKLY AND EASILY CONNECT KEGS TO THE DESIRED BLENDS OR SWITCH BLENDS WHEN CHANGING OUT BEER TYPES

ALL PANELS ARE CUSTOM BUILT TO MEET YOUR SPECIFIC REQUIREMENTS. PANELS BUILT USING THE LC SERIES QUICK DISCONNECT COUPLERS FROM COLDER PRODUCTS.



Call your sales representative for additional information, pricing and availability regarding this item.

Preassembled Secondary Regulator/Air Distributor Panels

Save Time and Money on Installs with Foxx's Preassembled Panels



BUILT WITH **TAPRITE** REGULATOR BODIES

BUILT WITH **FLOJET** BEER PUMPS

UPGRADE TO CORE® FOB FOR \$65.00 EACH

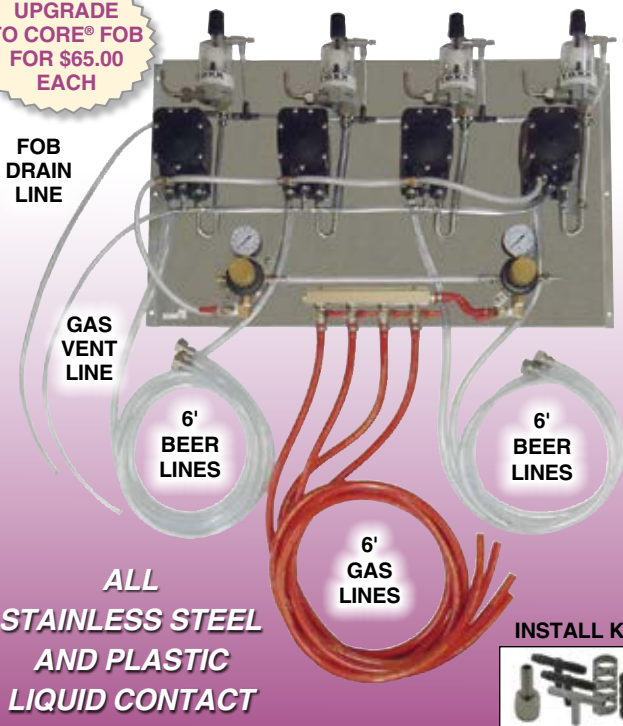

ALL STAINLESS STEEL AND PLASTIC LIQUID CONTACT

INSTALL KIT



Beer Pump Panels

WITH SECONDARY REGULATOR

TAPRITE® REGS AND FLOJET® PUMPS

Catalog No.	Pumps	6+	3+	Each
03D03-323	2 Pumps	183.95	188.95	196.95
03D03-324	3 Pumps	240.95	247.95	258.95
03D03-325	4 Pumps	301.95	309.95	323.95

Beer Pump Panels

INCLUDES: BEER PUMPS, FOBS, SECONDARY REGULATORS & AIR DISTRIBUTORS WITH SHUT-OFFS AND BACK-CHECK VALVES

All panels listed are built with: Flojet® beer pumps, Taprite® regulators, Pacific Beer Equipment® foam preventers, Accuflex® tubings

*** ALL NEW DESIGN ***

- Can easily attach incoming gas line to either left or right regulator
- Can make panel into a pass-thru by attaching included fittings
- Quickly, easily and independently remove regulators for service
- Panel layout allows for easy installation of flow reversal valves
- Gas vent line (MUST BE VENTED OUTSIDE OF ALL ENCLOSED AREAS)

TAPRITE® REGS AND FLOJET® PUMPS

Catalog No.	Pumps/FOBS	6+	3+	Each
03D03-351	1 Pump/FOB	218.95	227.95	236.95
03D03-352	2 Pumps/FOBs	344.95	358.95	373.95
03D03-353	3 Pumps/FOBs	490.95	511.95	532.95
03D03-354	4 Pumps/FOBs	618.95	643.95	671.95

Preassembled Beer Pump Panels

FROST BUSTER TWO-INTO-ONE HIGH-FLOW REGULATORS

HELPS PREVENT REGULATORS FROM FREEZING UP WHEN HIGH VOLUMES OF CO₂ ARE BEING USED. SPLITS CO₂ FLOW INTO TWO REGULATORS THEN BACK INTO ONE GAS LINE OUT.

AVAILABLE WITH THE FOLLOWING REGULATOR BODIES



U-BEND MANIFOLD AND ADDITIONAL TUBING SOLD SEPARATELY

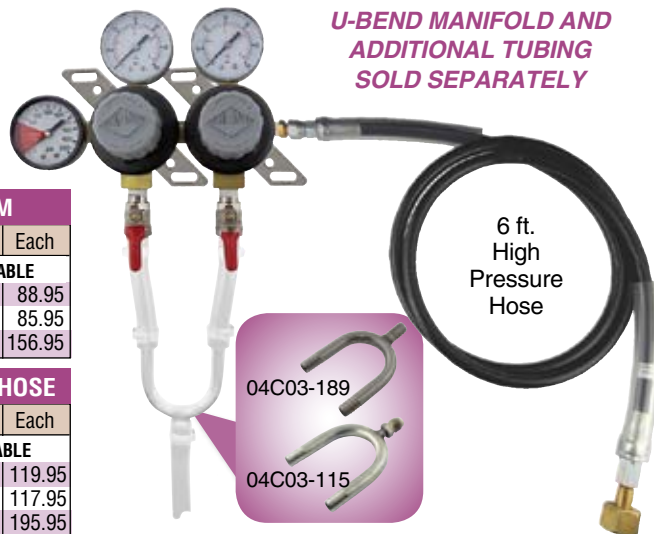

TANK MOUNT WITH CO₂ NUT/STEM

Catalog No.	Brand	24+	12+	6+	Each
03D03-147	Economy	TEMPORARILY UNAVAILABLE			
03C09-200	Taprite	79.95	82.95	85.95	88.95
03D03-208	Cornelius	76.95	80.95	82.95	85.95
03G07-111	Norgren	140.95	145.95	149.95	156.95

WALL MOUNT WITH 6' HIGH PRESSURE HOSE

Catalog No.	Brand	24+	12+	6+	Each
03D03-156	Economy	TEMPORARILY UNAVAILABLE			
03C09-205	Taprite	107.95	111.95	114.95	119.95
03D03-215	Cornelius	105.95	109.95	112.95	117.95
03G07-115	Norgren	175.95	182.95	187.95	195.95

04C03-189

04C03-115

Automatic Cylinder Changeover Valve

NEVER RUN OUT OF CO2, NITROGEN OR BLENDED GAS AGAIN

THE ELIMINATOR



THE ELIMINATOR
Is a completely automatic Gas cylinder changeover system that is non-electric, foolproof and designed for everlasting performance.

Available in 2, 4, 6, or 8 cylinder connections

20 YEAR
MANUFACTURER'S WARRANTY

The Eliminator Automatic Cylinder Changeover Valve

How THE ELIMINATOR Works



RIGHT SIDE IN USE

Both cylinders are full, right cylinder is in use as determined by the indicator pin protruding out the lower right side of the valve block.

RIGHT SIDE EMPTIES

When the right cylinder empties, The Eliminator switches over to the left cylinder. NOTE: the indicator pin now protrudes out the left.

REPLACE THE EMPTY

Once the Eliminator switches over to the full cylinder (left side), then it is now time to replace the empty cylinder on the right side.

LEFT SIDE IN USE

Once the empty has been replaced, the gauge now shows both cylinders full again and the left cylinder is in use. Note the indicator pin.

LEFT SIDE EMPTIES

When the left cylinder empties, the Eliminator switches over to the right cylinder. Note: the indicator pin now protrudes out the left side.

REPLACE THE EMPTY

Once the Eliminator switches over to the full cylinder (right side), then it is now time to replace the empty cylinder on the left side.

FOR CO ₂ CONNECTIONS		
Catalog No.	Description	Each
02A03-112	2 Tank Changeover	479.00
02A03-114	4 Tank Changeover	623.00
02A03-116	6 Tank Changeover	706.00
02A03-118	8 Tank Changeover	792.00

FOR NITROGEN CONNECTIONS		
Catalog No.	Description	Each
02A03-212	2 Tank Changeover	479.00
02A03-214	4 Tank Changeover	623.00
02A03-216	6 Tank Changeover	706.00
02A03-218	8 Tank Changeover	792.00

Manual CO₂ and N₂ Cylinder Changeovers

AN AFFORDABLE ALTERNATIVE TO AUTOMATIC CHANGEOVERS

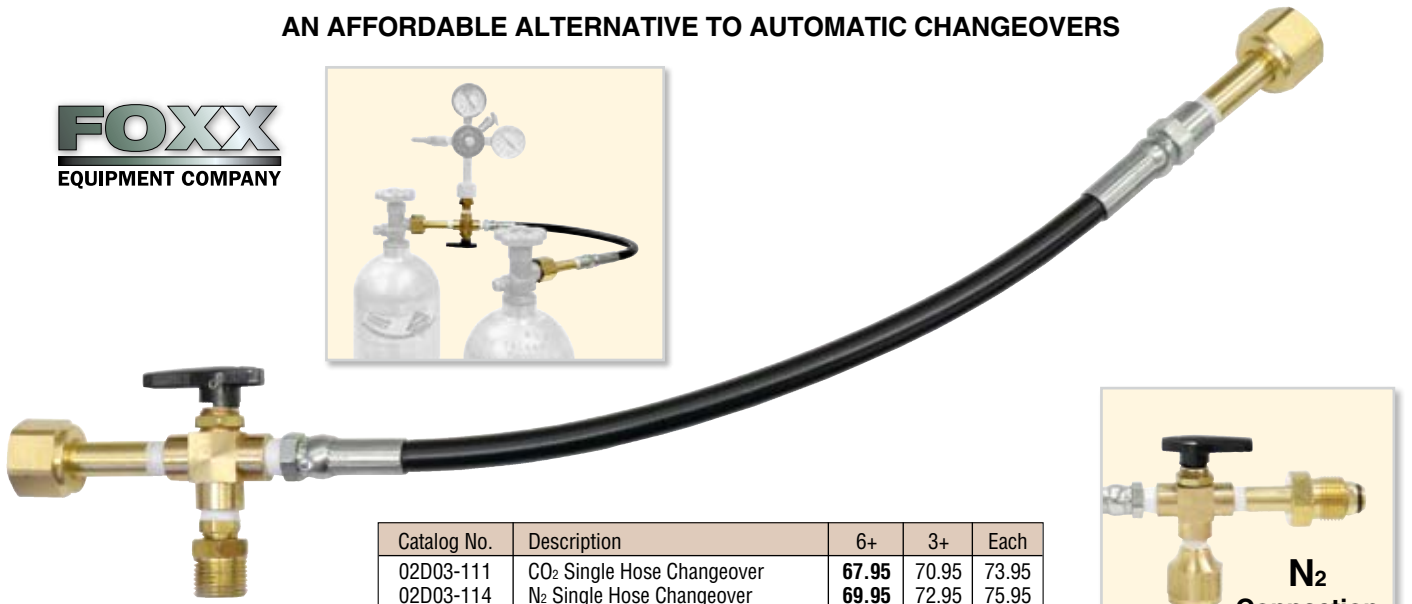

REGULATOR ATTACHES HERE

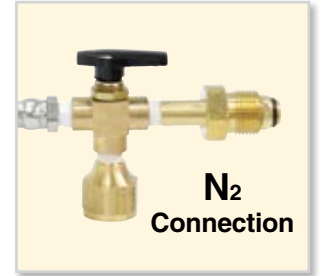

Catalog No.	Description	6+	3+	Each
02D03-111	CO ₂ Single Hose Changeover	67.95	70.95	73.95
02D03-114	N ₂ Single Hose Changeover	69.95	72.95	75.95

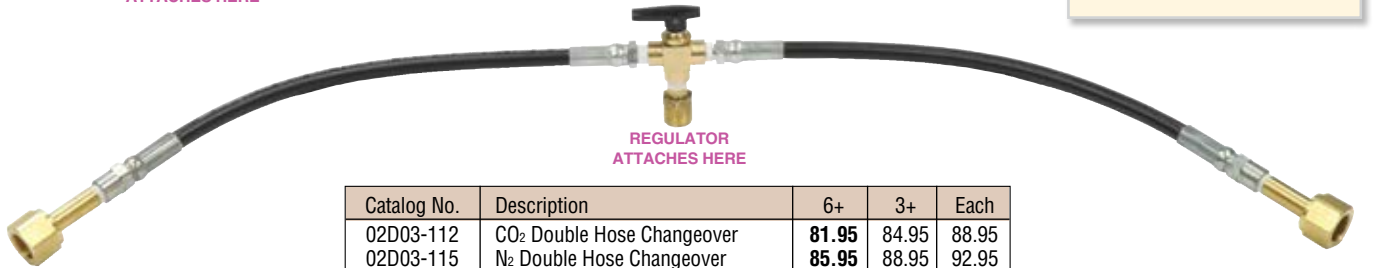

REGULATOR ATTACHES HERE

Catalog No.	Description	6+	3+	Each
02D03-112	CO ₂ Double Hose Changeover	81.95	84.95	88.95
02D03-115	N ₂ Double Hose Changeover	85.95	88.95	92.95

Additional price breaks available on most items. Login to your website account or contact your sales representative for pricing.

Low Pressure Changeover Valve

SWITCH CYLINDERS WITHOUT SERVICE INTERRUPTION

LOW COST ALTERNATIVE TO HIGH PRESSURE AND AUTO CHANGEOVERS

02C03-289
50+ **\$18.50**
25+ \$18.95 10+ \$19.95
Ea. \$20.95

Connect valve to the low pressure outlets of two regulators via beverage tubing and 1/4" MFL fittings

02S03-289
50+ **\$18.50**
25+ \$18.95 10+ \$19.95
Ea. \$20.95

6' High Pressure Regulator to Cylinder Hose

FOR WALL MOUNTING REGULATOR

One end connects directly to cylinder and the other end directly to 1/4" FPT inlet on regulator. Allows 6' for adjustable wall mounting.



AVAILABLE IN RIGHT OR LEFT HAND THREAD CONNECTIONS

Catalog No.	Description	Each
03G07-311	Right Hand Thread	28.95
03D03-199	Left Hand Thread	31.95

6' Blowout Cleaning Hose

Attaches directly to CO₂ cylinder. Blows dirt out of refrigeration condensers in seconds.

CAUTION: TURN ON CO₂ SLOWLY!



Catalog No.	Description	25+	10+	Each
02D03-141	Blowout Hose 6'	5.95	6.25	6.50
04E04-391	Fitting Only	3.75	-	3.95

Air Distributors – Extruded Aluminum Body



Catalog No.	Outlets	48+	24+	12+	6+	Each
03C03-400	2	7.50	7.95	8.50	8.95	9.50
03C03-401	3	10.50	10.95	11.50	11.95	12.50
03C03-402	4	11.95	12.50	12.95	13.50	13.95
03C03-403	5	15.50	16.50	16.95	17.95	18.95
03C03-404	6	19.95	20.50	20.95	21.95	22.95
03C03-405	7	22.95	23.95	24.50	24.95	25.95
03C03-406	8	23.95	24.95	25.50	25.95	26.95
03C03-407	9	23.95	24.95	25.95	26.95	27.95

1/4" MFL (INLET) + CAP/WASHER



1/4" MFL (OUTLETS)



WITHOUT
CHECK VALVE

Catalog No.	Outlets	48+	24+	12+	6+	Each
03C03-408	2	7.95	8.50	8.95	9.50	9.95
03C03-409	3	11.50	11.95	12.50	12.95	13.95
03C03-410	4	13.50	14.50	14.95	15.50	16.50
03C03-411	5	17.50	18.50	18.95	19.95	20.95
03C03-412	6	20.95	22.95	23.50	23.95	24.95
03C03-413	7	24.95	25.95	26.95	27.95	29.95
03C03-414	8	26.95	27.95	28.95	29.95	31.95
03C03-415	9	26.95	27.95	28.95	29.95	30.95

1/4" MFL (INLET) + CAP/WASHER



1/4" MFL (OUTLETS)



WITH
CHECK VALVE

Catalog No.	Outlets	48+	24+	12+	6+	Each
03C03-416	2	15.95	16.50	17.50	17.95	18.95
03C03-417	3	22.95	23.95	24.95	25.95	27.95
03C03-418	4	28.95	29.95	31.95	32.95	34.95
03C03-419	5	35.95	37.95	39.95	40.95	43.95
03C03-420	6	42.95	44.95	46.95	48.95	52.95
03C03-421	7	49.95	52.95	54.95	56.95	60.95
03C03-422	8	54.95	57.95	59.95	62.95	66.95
03C03-423	9	57.95	60.95	63.95	66.95	70.95

1/4" BARB (INLET) + CAP/WASHER



1/4" BARB SHUTOFF (OUTLETS)



WITH
CHECK VALVE

Catalog No.	Outlets	48+	24+	12+	6+	Each
03C03-424	2	14.95	15.95	16.50	16.95	17.95
03C03-425	3	21.95	22.95	23.95	24.95	25.95
03C03-426	4	26.95	27.95	28.95	30.95	32.95
03C03-427	5	32.95	34.95	36.95	37.95	40.95
03C03-428	6	40.95	41.95	43.95	45.95	47.95
03C03-429	7	46.95	48.95	50.95	52.95	55.95
03C03-430	8	50.95	53.95	54.95	57.95	60.95
03C03-431	9	53.95	55.95	57.95	60.95	63.95

3/8" BARB (INLET) + CAP/WASHER



3/8" BARB SHUTOFF (OUTLETS)



WITHOUT
CHECK VALVE

Catalog No.	Outlets	48+	24+	12+	6+	Each
03C03-432	2	16.50	17.50	17.95	18.95	19.95
03C03-433	3	23.95	24.95	25.95	26.95	28.95
03C03-434	4	29.95	30.95	32.95	33.95	35.95
03C03-435	5	36.95	38.95	39.95	41.95	44.95
03C03-436	6	43.95	45.95	47.95	49.95	53.95
03C03-437	7	50.95	53.95	55.95	57.95	61.95
03C03-438	8	55.95	58.95	60.95	63.95	67.95
03C03-439	9	58.95	62.95	64.95	67.95	71.95

3/8" BARB (INLET) + CAP/WASHER



3/8" BARB SHUTOFF (OUTLETS)



WITH
CHECK VALVE

Catalog No.	Outlets	48+	24+	12+	6+	Each
03C03-440	2	14.50	15.50	15.95	16.50	17.50
03C03-441	3	20.95	21.95	22.95	23.95	25.95
03C03-442	4	26.95	27.95	29.95	30.95	32.95
03C03-443	5	34.95	35.95	36.95	38.95	40.95
03C03-444	6	41.95	42.95	44.95	46.95	49.95
03C03-445	7	48.95	50.95	51.95	53.95	57.95
03C03-446	8	52.95	54.95	56.95	58.95	62.95
03C03-447	9	56.95	58.95	60.95	62.95	66.95

1/4" MFL (INLET) + CAP/WASHER



1/4" MFL SHUTOFF (OUTLETS)



WITH
CHECK VALVE

Catalog No.	Outlets	48+	24+	12+	6+	Each
03C03-448	2	14.50	14.95	15.50	16.50	17.50
03C03-449	3	20.95	21.95	22.95	23.95	25.95
03C03-450	4	26.95	27.95	28.95	29.95	31.95
03C03-451	5	33.95	35.95	36.95	37.95	40.95
03C03-452	6	40.95	42.95	43.95	45.95	48.95
03C03-453	7	47.95	49.95	50.95	53.95	56.95
03C03-454	8	51.95	54.95	55.95	58.95	61.95
03C03-455	9	55.95	57.95	59.95	61.95	65.95

1/4" MFL (INLET) + CAP/WASHER



1/4" MFL SHUTOFF (OUTLETS)



WITHOUT
CHECK VALVE

Air Distributors – Chrome Plated Brass Body

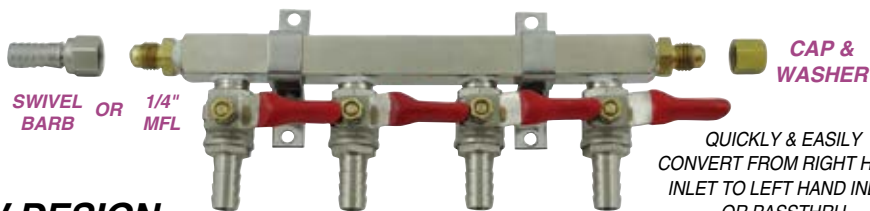

QUICKLY & EASILY
CONVERT FROM RIGHT HAND
INLET TO LEFT HAND INLET
OR PASSTHRU

NEW DESIGN

1/4" MFL (OUTLETS)



Catalog No.	Outlets	48+	24+	12+	6+	Each
03B03-400	2	7.95	8.50	8.95	9.50	9.95
03B03-401	3	11.50	11.95	12.50	12.95	13.95
03B03-402	4	14.50	14.95	15.50	15.95	16.95
03B03-403	5	17.95	18.95	19.95	20.95	21.95
03B03-404	6	20.95	21.95	22.95	23.95	24.95
03B03-405	7	23.95	24.95	25.95	26.95	28.95
03B03-406	8	26.95	27.95	28.95	29.95	31.95

1/4" MFL (OUTLETS)



Catalog No.	Outlets	48+	24+	12+	6+	Each
03B03-407	2	8.95	9.50	9.95	10.50	10.95
03B03-408	3	12.50	12.95	13.50	13.95	14.95
03B03-409	4	15.95	16.50	16.95	17.95	18.95
03B03-410	5	19.95	20.95	21.95	22.95	23.95
03B03-411	6	22.95	23.95	24.95	26.95	27.95
03B03-412	7	26.95	27.95	28.95	29.95	31.95
03B03-413	8	29.95	30.95	31.95	33.95	35.95

1/4" BARB SHUTOFF (OUTLETS)



Catalog No.	Outlets	48+	24+	12+	6+	Each
03B03-245	2	16.50	16.95	17.95	18.50	18.95
03B03-246	3	23.95	24.95	25.95	26.95	27.95
03B03-247	4	30.95	31.95	32.95	34.95	35.95
03B03-417	5	37.95	39.95	40.95	42.95	43.95
03B03-418	6	44.95	46.95	48.95	50.95	52.95
03B03-419	7	51.95	53.95	55.95	58.95	60.95
03B03-420	8	58.95	60.95	63.95	65.95	68.95

3/8" BARB SHUTOFF (OUTLETS)



Catalog No.	Outlets	48+	24+	12+	6+	Each
03B03-127	2	15.95	16.50	16.95	17.95	18.95
03B03-129	3	21.95	23.95	24.95	25.95	26.95
03B03-130	4	28.95	29.95	30.95	31.95	33.95
03B03-424	5	34.95	36.95	37.95	39.95	40.95
03B03-425	6	41.95	43.95	44.95	46.95	48.95
03B03-426	7	47.95	49.95	51.95	53.95	56.95
03B03-427	8	53.95	55.95	57.95	60.95	62.95

3/8" BARB SHUTOFF (OUTLETS)



Catalog No.	Outlets	48+	24+	12+	6+	Each
03B03-242	2	16.95	17.95	18.50	18.95	19.95
03B03-243	3	24.95	25.95	26.95	27.95	28.95
03B03-244	4	31.95	32.95	33.95	35.95	36.95
03B03-431	5	38.95	39.95	41.95	43.95	45.95
03B03-432	6	45.95	47.95	49.95	51.95	53.95
03B03-433	7	52.95	54.95	56.95	59.95	61.95
03B03-434	8	59.95	61.95	64.95	66.95	69.95

1/4" MFL SHUTOFF (OUTLETS)



Catalog No.	Outlets	48+	24+	12+	6+	Each
03B03-435	2	15.50	15.95	16.50	16.95	17.95
03B03-436	3	21.95	22.95	23.95	24.95	25.95
03B03-437	4	28.95	29.95	30.95	32.95	33.95
03B03-438	5	35.95	36.95	38.95	39.95	41.95
03B03-439	6	42.95	44.95	45.95	47.95	49.95
03B03-440	7	48.95	50.95	52.95	55.95	57.95
03B03-441	8	55.95	57.95	59.95	62.95	64.95

1/4" MFL SHUTOFF (OUTLETS)



Catalog No.	Outlets	48+	24+	12+	6+	Each
03B03-442	2	14.95	15.50	16.50	16.95	17.95
03B03-443	3	21.95	22.95	23.95	24.95	25.95
03B03-444	4	28.95	29.95	30.95	31.95	33.95
03B03-445	5	34.95	36.95	37.95	39.95	41.95
03B03-446	6	41.95	43.95	45.95	47.95	49.95
03B03-447	7	48.95	49.95	52.95	54.95	56.95
03B03-448	8	54.95	56.95	58.95	61.95	64.95

Air Distributors (Chrome Plated Brass Body)



Regulator and Air Distributor Fittings

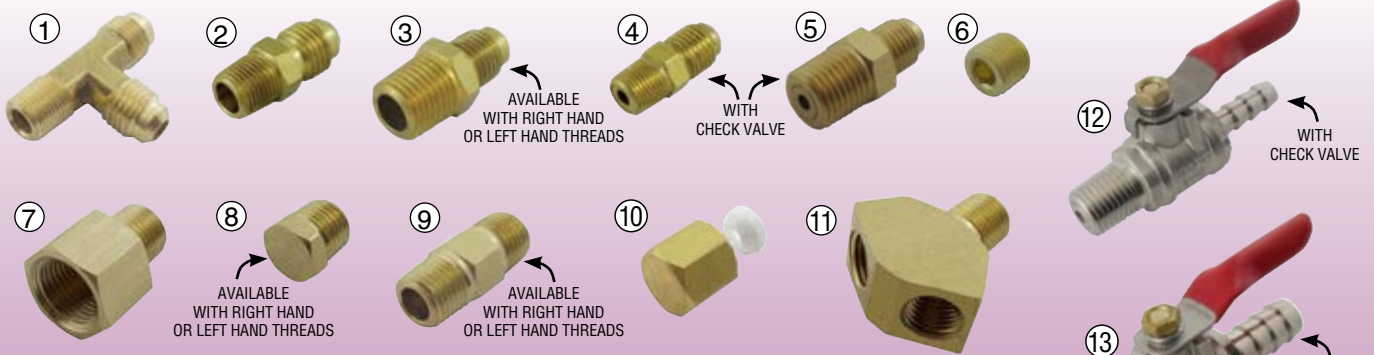

Ref. #	Catalog No.	Description	100+	50+	25+	Each
1	05B01-206	Tee, 1/8" MPT x 1/4" MFL x 1/4" MFL	1.96	2.08	2.18	2.38
2	05B01-228	Adapter, 1/4" MFL x 1/8" MPT	0.33	0.35	0.37	0.39
3a	05B01-183	Adapter, 1/4" MFL x 1/4" MPT (RH Thread)	0.55	0.60	0.65	0.70
3b	03C03-122	Adapter, 1/4" MFL x 1/4" MPT (LH Thread)	-	-	-	1.62
4	03G07-174	Check Valve, 1/8" MPT > 1/4" MFL	2.25	2.35	2.45	2.75
5	05B01-345	Check Valve, 1/4" MPT > 1/4" MFL	0.90	0.95	1.00	1.50
6a	05B01-134	Pipe Plug, 1/8" MPT	0.32	0.34	0.36	0.39
6b	05B01-135	Pipe Plug, 1/4" MPT	0.42	0.45	0.47	0.51
7a	05B01-162	Reducer, 1/4" FPT x 1/8" MPT	0.55	0.58	0.61	0.66
7b	05B01-166	Reducer, 3/8" FPT x 1/4" MPT	1.05	1.10	1.15	1.25
8a	05B01-154	Hex Plug, 1/4" MPT (RH Thread)	0.42	0.44	0.46	0.50
8b	03S07-101	Hex Plug, 1/4" MPT (LH Thread)	0.94	1.00	1.05	1.14
9a	03G07-241	Hex Nipple, 1/4" MPT x 1/4" MPT (RH Thread)	0.95	1.00	1.05	1.25
9b	03C07-245	Hex Nipple, 1/4" MPT x 1/4" MPT (LH Thread)	1.90	2.01	2.13	2.24
9c	05C03-101	Hex Nipple, 1/4" MPT x 1/4" MPT (LHT x RHT)	2.44	2.58	2.74	2.87
10	03G07-237	Cap and Flare Washer, 1/4" FFL	0.37	0.39	0.41	0.45
11	03A03-121	Wye, 1/4" MPT x 1/4" FPT x 1/4" FPT	2.36	2.50	2.66	2.80
12	05B01-341	Ball Valve, 1/4" MPT > 1/4" B (with check)	4.01	4.25	4.52	4.95
13a	05B01-337	Ball Valve, 1/4" MPT x 3/8" B (no check)	3.50	3.95	4.50	4.95
13b	05B01-342	Ball Valve, 1/4" MPT > 3/8" B (with check)	4.00	4.30	4.60	4.95
14a	05B01-344	Ball Valve, 1/4" MPT x 1/4" MFL (no check)	3.75	3.95	4.50	4.95
14b	05B01-343	Ball Valve, 1/4" MPT > 1/4" MFL (with check)	3.75	3.95	4.50	4.95
15a	05B01-346	Ball Valve, 1/4" B x 1/4" B Lead Free	4.25	4.50	4.95	5.50
15b	05B01-347	Ball Valve, 3/8" B x 3/8" B Lead Free	4.60	4.85	5.15	5.50

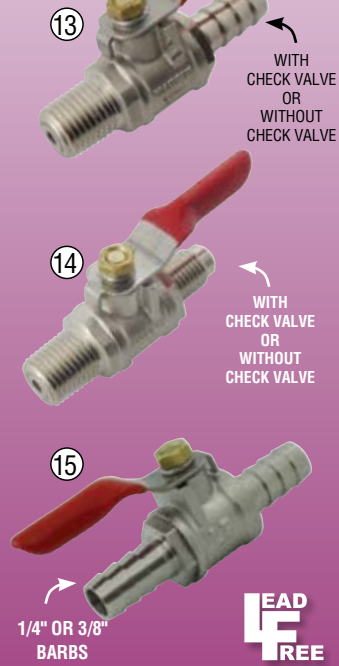

Additional price breaks available on most items. Login to your website account or contact your sales representative for pricing.

Nitrogen Valve Connectors

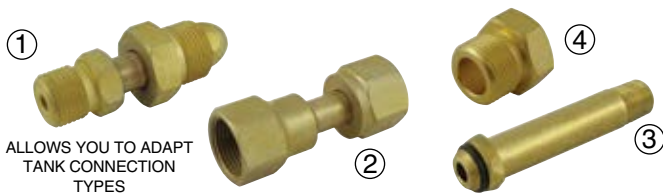

Ref. #	Catalog No.	Description	24+	12+	6+	Each
1	02F08-101	Adapter, N ² Cyl. x CO ₂ Reg.	6.50	6.95	7.25	7.50
2	02F08-111	Adapter, CO ₂ Cyl. x N ² Reg.	6.50	6.75	6.95	7.50
3a	02F08-103	Nipple, Nitrogen 3" L (RHT)	2.05	2.20	2.50	2.95
3b	02A03-105	Nipple, Nitrogen 3" L (LHT)	2.10	2.25	2.50	2.95
4	02F08-102	Nut, Nitrogen	2.50	2.75	2.95	3.50
-	15H06-295	O-ring, (fits ref. #3)	7.38	7.69	8.53	15.00

CO₂ Quick Coupler



Ref. #	Catalog No.	Description	50+	25+	Each
1	03B04-101	Male Coupler (5/16" B)	1.75	1.95	2.25
2	03B04-102	Female Coupler (5/16" B)	3.95	4.50	4.95

CO₂ Valve Connectors



Ref. #	Catalog No.	Description	24+	12+	6+	Each
1a	02A03-102	Nipple, CO ₂ (RHT)	1.50	1.75	2.00	2.25
1b	02A03-103	Nipple, CO ₂ (LHT)	1.55	1.75	2.00	2.25
2	02A03-101	Nut, CO ₂	1.95	2.25	2.50	2.95

CO₂ Washers



Ref. #	Catalog No.	Description	300+	100+	25+	Each
1	02C03-188	Hard Fiber Washer	4.95	5.25	-	10.00
2	02H06-294	Nylon Washer	4.95	5.50	-	10.00
3	02H08-111	ABC Permanent O-ring	0.60	0.65	0.70	0.75

TAPRITE Sanke Picnic Pumps

HIGH QUALITY • DURABLE & RELIABLE • EASY-TO-USE



18S07-101



18S07-100

The **Pony Pump** is a compact air pump that fits any American sanke style keg.

FEATURES

- Inexpensive (sellable to customers)
- Lightweight (weighs only 12 oz.)
- Stationary with "NO-SPRITZ" seal
- Pressure relief valve
- 2' flexible hose with plastic faucet

The **Bronco Pump** is a heavy-duty pump that fits any American sanke style keg.

FEATURES

- Designed for long term repeated use
- High volume air pump
- Metal base with lever engagement
- Pressure relief valve
- 2' flexible hose with plastic faucet

24+ \$15.25

12+ \$16.50 Ea. \$17.95

24+ \$32.95

12+ \$34.95 Ea. \$37.95

Additional price breaks available on most items. Login to your website account or contact your sales representative for pricing.

TAPRITE Pony & Bronco Pump Replacement Parts

PONY PUMP

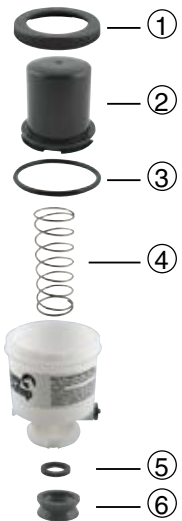

UNIVERSAL REPLACEMENT 2' HOSE AND FAUCET



18D03-123

25+ \$2.40

10+ \$2.55

Ea. \$2.67

BRONCO PUMP



PONY PUMP REPLACEMENT PARTS

Ref. #	Catalog No.	Description	25+	10+	Each
1	18S07-106	Locking Ring	2.06	2.19	2.30
2	18S07-107	Piston	3.43	3.64	3.82
3	18S07-105	Piston O-ring	0.36	0.39	0.41
4	18S07-111	Piston Spring	0.38	0.41	0.43
5	18S07-109	Probe Seal	0.45	0.48	0.51
6	18S07-104	Bottom Seal	2.07	2.19	2.30
-	18S07-113	Check Valve	4.11	4.35	4.62
-	18S07-114	Check Valve Retainer	0.55	0.58	0.61

BRONCO PUMP REPLACEMENT PARTS

Ref. #	Catalog No.	Description	25+	10+	Each
1	18S07-106	Locking Ring	2.06	2.19	2.30
2	18S07-107	Piston	3.43	3.64	3.82
3	18S07-105	O-ring, Piston	0.36	0.39	0.41
4	18S07-111	Piston Spring	0.38	0.41	0.43
5	18S07-108	Beer Seal	0.26	0.27	0.29
6	18S07-103	Air Seal	0.49	0.52	0.55
7	07K09-108	Bottom Seal	0.57	0.60	0.74
-	18S07-113	Check Valve	4.11	4.35	4.62
-	18S07-114	Check Valve Retainer	0.55	0.58	0.61
-	*12J06-105	Coupler Body O-ring	0.13	0.15	0.20
8	18S07-112	Pump Body	10.95	11.95	12.95

* Inside coupler body (requires two)



Upright Picnic Pumps – American Sanke

HIGH QUALITY – LONG LASTING – TROUBLE FREE – OUT PERFORMS MOST PUMPS ON THE MARKET

ALL MODELS ON THIS PAGE

FEATURES

- Plated forged brass coupler body
- KROME models have a plated brass cylinder
- ABECO models have a 304 S/S cylinder
- Built-in internal back-check valve
- KROME dispense models have a S/S pump rod
- ABECO models have a solid brass pump rod
- 2' length tube with plastic dispense faucet
- Quality replacement parts available on all models



Catalog No.	24+	12+	Each
18K03-100	29.50	29.95	32.95

Catalog No.	24+	12+	Each
18K03-101	33.95	35.95	38.95

Additional price breaks available on most items. Login to your website account or contact your sales representative for pricing.



Catalog No.	24+	12+	Each
18A03-139	40.95	42.95	46.95

Catalog No.	24+	12+	Each
18A03-138	42.95	45.95	49.95



Catalog No.	24+	12+	Each
18A03-239	40.95	42.95	46.95

Catalog No.	24+	12+	Each
18A03-238	42.95	45.95	49.95



Catalog No.	24+	12+	Each
18A03-141	36.95	38.95	41.95

Catalog No.	24+	12+	Each
18B03-240	38.95	41.95	45.95



Catalog No.	24+	12+	Each
18A03-142	38.95	41.95	45.95

Catalog No.	24+	12+	Each
18A03-144	41.95	43.95	47.95

American Sanke Picnic Pumps

European Picnic Pumps

CHROME PLATED BRASS BODY – NICKEL PLATED BRASS PUMP

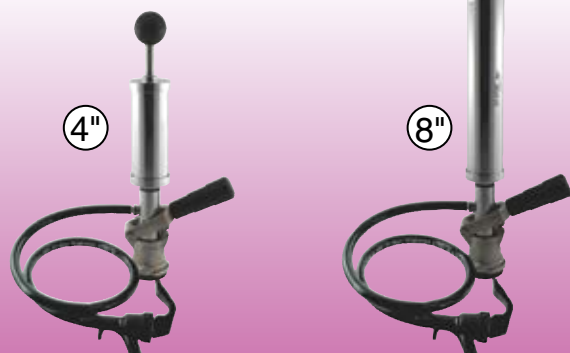

Catalog No.	24+	12+	Each
18K03-103	29.50	29.95	32.50

Catalog No.	24+	12+	Each
18K03-104	33.95	35.95	38.95

High-Rise Picnic Pumps

TIME TO STEP UP FROM A TRADITIONAL FLEXIBLE HOSE PICNIC PUMP TO A NICER SET-UP WITH A REAL FAUCET

WORKS WITH MOST BRANDS AND TYPES OF COUPLERS

WITHOUT A COUPLER			
Catalog No.	6+	3+	Each
18B03-155	46.95	49.95	54.95

AMERICAN SANKE COUPLER			
Catalog No.	6+	3+	Each
18B03-252	69.95	72.95	79.95

EUROPEAN SANKE COUPLER			
Catalog No.	6+	3+	Each
18B03-253	71.95	76.95	83.95

REPLACEMENT COMPONENTS			
Catalog No.	25+	10+	Each
18B03-156	12.50	13.95	14.95
18B03-192	2.86	3.04	3.18

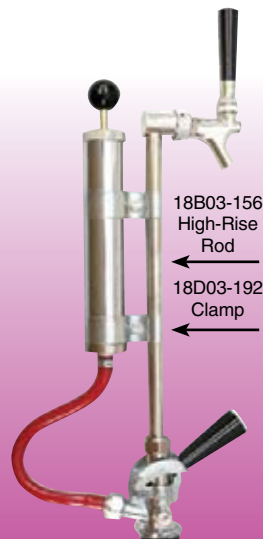

High-Rise CO₂ Picnic Pump & Regulators

FOR DISPENSING ALL TYPES OF BEER, KEGGED WINE AND NITRO COFFEE



AVAILABLE IN:
0-19 PSI
OR
0-50 PSI



ALL REGULATORS ACCEPT ANY OF THE LISTED HIGH PURITY GAS CYLINDERS



DISPENSING OF:
MOST COMMON BEERS



DISPENSING OF:
WINE ALL TYPES



DISPENSING OF:
COFFEE STOUTS WINES

Ref. #	Catalog No.	Description	6+	3+	Each
1	18L02-101	High-Rise Pump Kit	234.95	250.95	272.95
2	18L02-102	Regulator 0-19 PSI	144.95	152.95	156.95
2	18L02-103	Regulator 0-50 PSI	144.95	152.95	156.95
3	18L02-104	Regulator 0-19 PSI (1/4" FFL)	150.95	158.95	162.95
3	18L02-105	Regulator 0-50 PSI (1/4" FFL)	150.95	158.95	162.95
3	18L02-106	Regulator 0-19 PSI (Beer Nut)	150.95	158.95	162.95

Ref. #	Catalog No.	Description	6+	3+	Each
3	18L02-107	Regulator 0-50 PSI (Beer Nut)	150.95	158.95	162.95
Ref. #	Catalog No.	Description	24+	12+	Each
4	02L02-108	CO ₂ Cartridges 74 gm (2 pk.)	16.95	17.95	18.95
Ref. #	Catalog No.	Description	12+	6+	Each
5	02L02-107	Argon Cartridges 26 gm (2 pk.)	22.95	23.95	25.95
6	02L02-106	Nitrogen Cartridges 18 gm (1 ea.)	12.95	13.95	14.95



Replacement Pumps for Picnic Pumps

HIGH QUALITY & DURABLE • 304 STAINLESS STEEL CYLINDER AND PUMP ROD



8"
5/16"
Barb
No Check Valve

18B03-138

24+ **\$16.95** 12+ \$17.95
6+ \$18.95 Ea. \$20.95



4"
Threaded
with
Check Valve

18A03-140

24+ **\$15.95** 12+ \$16.95
6+ \$17.95 Ea. \$18.95



8"
Threaded
with
Check Valve

18B03-137

24+ **\$16.95** 12+ \$17.95
6+ \$18.95 Ea. \$19.95

Ref. #	Catalog No.	Description	Each
1	18A03-103	Piston/O-ring/Nuts	3.36
2	18B03-121	O-ring only	0.22
3	18A03-132	Spring	0.60
4	18A03-137	Cap (Plated Brass)	2.79
5	18A03-128	Knob (Round)	1.46
6	18A03-104	4" Length Assembly	8.95
6	18A03-105	8" Length Assembly	9.50
7	12J06-103	Thomas Check Valve	0.52
8	07B03-124	Pump Washer	0.19
9	18A03-106	4" Cylinder w/Threaded Cap	9.95
9	18A03-107	8" Cylinder w/Threaded Cap	11.50
9	18A03-108	8" Cylinder w/Barbed Cap	11.50

Picnic Pump Parts

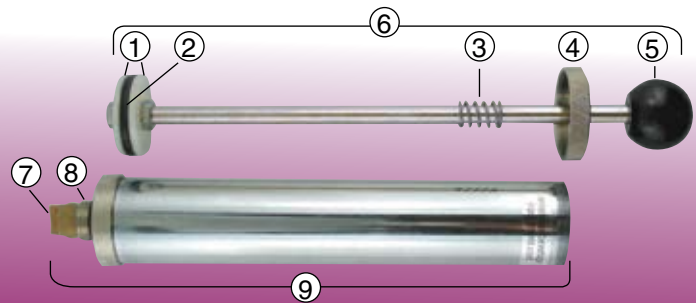

Additional price breaks available on most items. Login to your website account or contact your sales representative for pricing.



Adapters and Faucet Hoses



Ref. #	Catalog No.	Description	25+	10+	Each
1	12B03-232	5/16" Barb x Pump Thread	1.75	1.85	1.95
2	07B03-245	Threaded Pump x Coupler Probe	1.50	1.75	1.95
3	18A03-118	Threaded Pump x Coupler Probe	12.95	13.95	14.98

Ref. #	Catalog No.	Description	25+	10+	Each
4	18A03-102	Barbed Plastic Faucet (NSF)	1.65	1.75	1.95
5	18D03-122	"Beer" Hex Nut x Flex Faucet (4')	4.50	4.75	4.95
6	18D03-120	"Beer" Wing Nut x Flex Faucet (4')	4.75	5.25	5.50

Lubricants for Pumps

- NSF listed
- FDA approved
- Odorless
- Tasteless



Catalog No.	Description	12+	6+	Each
20D08-116	Purity Sanitary Lubricant (16 oz.)	7.50	7.95	8.50
20A01-112	Dow Corning Silicone 100% (5.3 oz.)	18.95	19.95	20.95
20G09-215	Petrol-Gel Sanitary Lubricant (4 oz.)	2.95	3.25	3.50

Picnic Pump Cleaning Adapter

FOR EASY CLEANING OF PICNIC PUMPS



Faucet adapter on cleaning pump screws into one side of the adapter and allows picnic pump to attach to the other side of the adapter.

20K03-150
25+ **\$4.25**
10+ \$4.50 Ea. \$4.95



Super Sturdy & Flexible Tubs



MADE IN SPAIN

GORILLA TUBS® (FORMERLY TUBTRUGS®) ARE BUILT TO LAST — HAVING EXTREMELY STRONG HANDLES AND A FLEXIBLE BODY MAKES HANDLING EASIER THAN CONVENTIONAL RIDGID TUBS AND MUCH EASIER TO STORE AND TRANSPORT

PERFECT FOR ICING DOWN KEGS, BOTTLES AND CANS

ALSO GREAT FOR CARRYING, HAULING OR STORING JUST ABOUT ANYTHING YOU DESIRE



INSIDE DIMENSIONS: 22" top diameter x 17" bottom diameter x 14" height

18U07-107

19.8 GALLON (BLACK)

24+ **\$15.95** 12+ \$16.95
6+ \$17.95 Ea. \$18.95

18U07-105

19.8 GALLON (RED)

24+ **\$18.95** 12+ \$19.95
6+ \$20.95 Ea. \$21.95

18U07-106

19.8 GALLON (BLUE)

24+ **\$18.95** 12+ \$19.95
6+ \$20.95 Ea. \$21.95

Dispenser Drain Tray

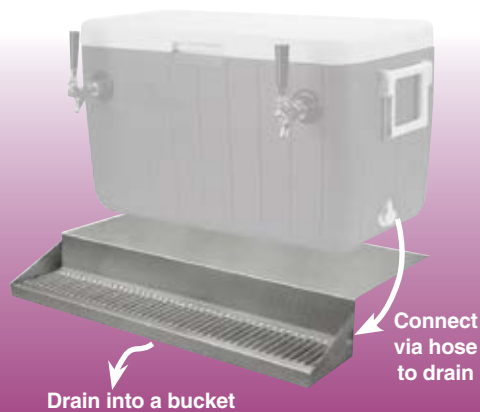

HELD IN PLACE BY WEIGHT OF DISPENSER BOX

- 1/2" BSP drain tube
- 7/8" diameter inlet hole for cooler draining
- 24" L x 5" W x 1" D

11F09-400

4+ **\$131.95**
2+ 135.95
Ea. 138.95

5 lb. Cylinder Hanger



HANGS ON CONTAINER TO KEEP CYLINDER HANDY

- Stainless steel
- 18-1/2" Length
- 5-1/2" Diameter

18F09-129

4+ **\$15.95**
2+ \$16.95
Ea. \$17.95

Tubtrugs, Dispenser Drain and Tapping Kits

Tapping Kits for Portable Dispensers

304 GRADE STAINLESS STEEL LIQUID CONTACT
GOOD FOR DISPENSING ALL TYPES OF BEVERAGES



LIQUID CONTACT

PURCHASE CO₂ TANK SEPARATELY

KITS INCLUDE:
304 S/S Coupler(s) and tail pieces, regulator with shutoff lever, 5' beer/gas lines with washers

LIQUID CONTACT

Catalog No.	Couplers	6+	3+	Each
18D03-501	1	78.95	81.95	85.95
18D03-503	2	117.95	122.95	128.95
18D03-505	3	170.95	177.95	184.95
18D03-507	4	209.95	217.95	227.95
18D03-509	5	249.95	259.95	270.95
18D03-511	6	289.95	301.95	314.95



Cold Plate Dispensers - 48 Qt.

MODERATE VOLUME DISPENSING

10" x 15" COLD PLATE DISPENSERS					
Catalog No.	Faucets	Color	6+	3+	Each
18D05-100	1	Red	159.95	166.95	173.95
18D05-101	2	Red	213.95	221.95	231.95
18D05-102	3	Red	291.95	303.95	317.95
18D05-103	4	Red	354.95	369.95	385.95
18D05-104	6	Red	461.95	479.95	500.95
18D05-110	1	Blue	159.95	166.95	173.95
18D05-111	2	Blue	213.95	221.95	231.95
18D05-112	3	Blue	291.95	303.95	317.95
18D05-113	4	Blue	354.95	369.95	385.95
18D05-114	6	Blue	461.95	479.95	500.95

CIRCUITS:

18' length
304 S/S
5/16" O.D.
1/4" I.D.

DIMENSIONS:

25" length
14" width
13.5" height



LIQUID CONTACT

Additional price breaks available on most items. Login to your website account or contact your sales representative for pricing.

Coil Dispensers - 48 Qt.

HIGH VOLUME DISPENSING

50' COIL DISPENSERS					
Catalog No.	Faucets	Color	6+	3+	Each
18D05-200	1	Red	127.95	133.95	138.95
18D05-201	2	Red	224.95	233.95	243.95
18D05-202	3	Red	327.95	341.95	356.95
18D05-203	4	Red	422.95	439.95	458.95
18D05-204	5	Red	537.95	558.95	582.95
18D05-210	1	Blue	127.95	133.95	138.95
18D05-211	2	Blue	224.95	233.95	243.95
18D05-212	3	Blue	327.95	341.95	356.95
18D05-213	4	Blue	422.95	439.95	458.95
18D05-214	5	Blue	537.95	558.95	582.95

Redesigned to allow you to serve any type of beer without worrying about interaction with brass components



LIQUID CONTACT

70' COIL DISPENSERS					
Catalog No.	Faucets	Color	6+	3+	Each
18D05-300	1	Red	151.95	157.95	164.95
18D05-301	2	Red	271.95	283.95	295.95
18D05-302	3	Red	399.95	416.95	434.95
18D05-303	4	Red	504.95	524.95	546.95
18D05-310	1	Blue	151.95	157.95	164.95
18D05-311	2	Blue	271.95	283.95	295.95
18D05-312	3	Blue	399.95	416.95	434.95
18D05-313	4	Blue	504.95	524.95	546.95

120' COIL DISPENSERS					
Catalog No.	Faucets	Color	6+	3+	Each
18D05-400	1	Red	199.95	208.95	217.95
18D05-401	2	Red	368.95	383.95	400.95
18D05-410	1	Blue	199.95	208.95	217.95
18D05-411	2	Blue	368.95	383.95	400.95

304 S/S COIL LENGTHS

50' length
70' length
120' length

DIMENSIONS:

25" length
14" width
13.5" height



LIQUID CONTACT

Portable Cold Plate and Coil Coolers

Purchase the Tapping Kits separately (see page 226) and purchase the CO₂ Cylinders separately (see page 2)

Coil Dispensers - 18 Qt.

HIGH VOLUME DISPENSING

50' COIL DISPENSERS					
Catalog No.	Faucets	Color	6+	3+	Each
18D05-500	1	Red	122.95	127.95	133.95
18D05-501	2	Red	225.95	235.95	245.95
18D05-510	1	Blue	122.95	127.95	133.95
18D05-511	2	Blue	225.95	235.95	245.95

DIMENSIONS:

15" length
6.25" width
15.5" height



LIQUID CONTACT



CIRCUITS:
 18' length
 304 S/S
 5/16" O.D.
 1/4" I.D.

DIMENSIONS:
 25" length
 14" width
 13.5" height



LIQUID CONTACT

Cold Plate Dispensers - 54 Qt.

MODERATE VOLUME DISPENSING

10" x 15" COLD PLATE DISPENSERS					
Catalog No.	Faucets	Color	6+	3+	Each
18D05-600	1	S/S	301.95	314.95	328.95
18D05-601	2	S/S	358.95	372.95	389.95
18D05-602	3	S/S	434.95	452.95	471.95
18D05-603	4	S/S	506.95	527.95	550.95
18D05-604	6	S/S	631.95	658.95	686.95

Additional price breaks available on most items. Login to your website account or contact your sales representative for pricing.

Coil Dispensers - 54 Qt.

HIGH VOLUME DISPENSING

50' COIL DISPENSERS					
Catalog No.	Faucets	Color	6+	3+	Each
18D05-700	1	S/S	270.95	281.95	293.95
18D05-701	2	S/S	370.95	385.95	402.95
18D05-702	3	S/S	472.95	491.95	513.95
18D05-703	4	S/S	574.95	598.95	624.95
18D05-704	5	S/S	680.95	709.95	740.95
18D05-705	6	S/S	762.95	793.95	827.95

70' COIL DISPENSERS					
Catalog No.	Faucets	Color	6+	3+	Each
18D05-800	1	S/S	294.95	306.95	319.95
18D05-801	2	S/S	420.95	437.95	456.95
18D05-802	3	S/S	543.95	566.95	590.95
18D05-803	4	S/S	681.95	710.95	741.95

120' COIL DISPENSERS					
Catalog No.	Faucets	Color	6+	3+	Each
18D05-900	1	S/S	342.95	356.95	372.95
18D05-901	2	S/S	514.95	535.95	558.95



Redesigned to allow you to serve any type of beer without worrying about interaction with brass components



LIQUID CONTACT



Purchase the Tapping Kits separately (see page 226) and purchase the CO₂ Cylinders separately (see page 2).



304 S/S
CIRCUITS:
 50' length
 70' length
 120' length

DIMENSIONS:
 25" length
 14" width
 13.5" height



LIQUID CONTACT

Jumper Line – 5' Length

CONNECTS DISPENSER TO KEG COUPLER



HEX NUT



LIQUID CONTACT



WING NUT

Catalog No.	Fits	10+	5+	Each
18D03-192	Hex Nut	6.58	6.99	7.33
18D03-191	Wing Nut	7.08	7.52	7.89



Cold Plates for Beer

Catalog No.	Designed to fit	No. of Circuits	Circuit Lengths	Tube I.D.	3+	Each
13A02-206	8" x 14"	3	12'	1/4"	120.95	123.95
13A02-208	8" x 14"	5	12'	1/4"	147.95	151.95
13A02-209	8" x 14"	6	12'	1/4"	158.95	162.95
13A02-210	8" x 14"	7	12'	1/4"	150.95	154.95
13A02-228	8" x 14"	8	12'	1/4"	185.95	190.95
13A02-211	10" x 15"	1	18'	1/4"	82.95	84.95
13A02-212	10" x 15"	2	18'	1/4"	94.95	97.95
13A02-213	10" x 15"	3	12'	5/16"	130.95	134.95
13A02-214	10" x 15"	4	12'	5/16"	151.95	155.95
13A02-215	10" x 15"	5	18'	1/4"	181.95	186.95
13A02-218	10" x 15"	6	18'	1/4"	187.95	192.95
13A02-222	12" x 18"	4	18'	5/16"	248.95	255.95

99.7% PURE ALUMINUM **304 S/S** **STAINLESS STEEL PRODUCT LINES**

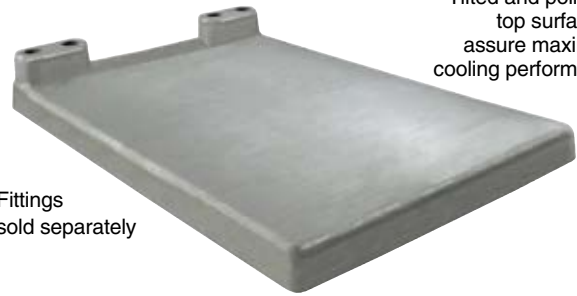

Tilted and polished top surface to assure maximum cooling performance

Fittings sold separately

Wire Racks - Fits 10" x 15" Cold Plates

Keeps the cold plate lifted and out of standing water. Also allows the ice to completely surround the cold plate to maximize its cooling efficiency.

10+ \$8.95 **5+ \$9.50** **Ea. \$9.95** **13K02-100**

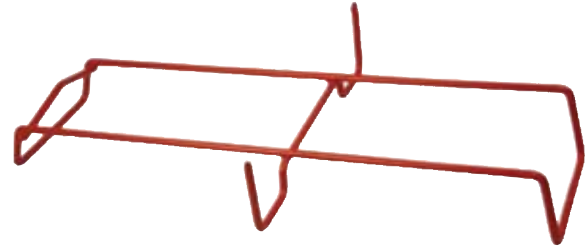

Fittings for Cold Plates

Ref.#	Catalog No.	Description	100+	50+	25+	Each
1	04C03-230	1/4" Barb x 1/2-16 MFL	1.30	1.40	1.50	1.75
2	04C03-126	3/8 Barb x 1/2-16 MFL	1.50	1.60	1.70	1.80
3	04C03-233	1/4" MFL x 1/2-16 MFL	1.10	1.20	1.30	1.40

FLARE WASHER PRICES PER 100

Ref.#	Catalog No.	Description	300+	100+	Each
4	04E04-290	1/2-16 Flare Washer	3.99	4.25	8.00



304 Grade Stainless Steel Coils with Fittings



Ref.	Catalog No.	Length	Coiled	O.D.	Fittings	Approx. Dimensions	3+	Each
1	19A03-105	50'	Univ	5/16"	Yes	5" Dia. x 8-1/2" H	61.95	64.95
2	19A03-100	50'	Left	5/16"	Yes	9-1/2" Dia. x 7" H	59.95	61.95
2	19A03-102	50'	Right	5/16"	Yes	9-1/2" Dia. x 7" H	59.95	61.95
3	19A03-208	70'	Univ	5/16"	Yes	6" Dia. x 9" H	85.95	88.95
4	19A03-107	70'	Left	5/16"	Yes	10 1/2" Dia. x 5-1/2" H	80.95	84.95
4	19A03-106	70'	Right	5/16"	Yes	10 1/2" Dia. x 5-1/2" H	80.95	84.95

Ref.	Catalog No.	Length	Coiled	O.D.	Fittings	Approx. Dimensions	3+	Each
5	19A03-103	120'	Left	5/16"	Yes	9-1/2" Dia. x 10" H	137.95	142.95
5	19A03-101	120'	Right	5/16"	Yes	9-1/2" Dia. x 10" H	137.95	142.95
6	19U07-050	50'	Univ	5/16"	Yes	4-3/4" x 7-1/4" x 6" H	63.95	65.95
7	19U07-070	70'	Univ	5/16"	Yes	9" x 9" x 9-1/4" H	70.95	72.95
8	19U07-120	120'	Univ	5/16"	Yes	9-3/4" x 9-3/4" x 9-1/4" H	120.95	124.95
-	-	-	-	-	-	-	-	-

Grommets



Catalog No.	Size	25+	10+	Each
05A03-144	1/4"	0.77	0.82	0.86
05A03-146	5/16"	0.77	0.82	0.86
05A03-148	3/8"	0.77	0.82	0.86

Ferrules



Catalog No.	Size	25+	10+	Each
05A03-143	1/4"	1.39	1.48	1.55
05A03-145	5/16"	1.39	1.48	1.55
05A03-147	3/8"	1.39	1.48	1.55

Wall Couplings 3/8" Bore



PLATED BRASS				
Catalog No.	Length	12+	6+	Each
13B03-147	3"	8.95	9.50	9.95
13B03-148	4"	10.95	11.50	11.95
304 STAINLESS STEEL				
13B03-149	3"	11.95	12.95	13.95
13B03-150	4"	23.95	24.95	26.95

3-1/2" Shanks for Dispensers



PLATED BRASS				
Catalog No.	Length	24+	12+	Each
12B03-112	1/4" OD	9.95	10.50	10.95
12A03-139	5/16" OD	10.95	11.50	11.95
304 STAINLESS STEEL				
12K07-103	1/4" OD	9.95	10.50	10.95
12K07-203	5/16" OD	12.95	13.95	14.95

Washers for Wall Couplings



Catalog No.	Type	50+	25+	Each
04B03-146	Rubber	0.76	0.84	0.92
04B03-207	Aluminum	0.69	0.59	0.49

Jumper Line – 5' Length

CONNECTS DISPENSER TO KEG COUPLER



Catalog No.	Fits	10+	5+	Each
18D03-195	Hex Nut	5.25	5.55	5.95
18D03-190	Wing Nut	5.95	6.50	6.75

Additional price breaks available on most items. Login to your website account or contact your sales representative for pricing.

Iceless Pour™ Thermal Insulation Jackets

SERVING THE PERFECT TEMPERATURE BEER AT AN OUTDOOR EVENT JUST GOT A WHOLE LOT EASIER



**YOUR KEG'S
NEW BEST FRIEND**

- NO** additional items needed for use
- NO** ice to dump or replenish
- NO** tubs or buckets to buy and haul around
- NO** leaks, as cracked tubs will often do
- NO** dangerous, slippery wet floors from ice
- NO** maintenance required for use
- NO** more buying, hauling ice everywhere
- YES** up to 10 hours of ice cold beer



Use with
Jockey Box Dispenser (best)
or just a picnic pump

20P01-100
1/6 BARREL
4+ **\$176.95**
2+ \$181.95
Ea. \$186.95

20P01-101
1/2 BARREL
4+ **\$229.95**
2+ \$234.95
Ea. \$239.95



Insulated Keg Jacket

DESIGNED TO INSULATE AND MAINTAIN TEMPERATURE

USE WITH 1/2 OR 1/4 BARRELS

**KEEPS BEER
COLD**

- Limits exposure to external temperatures
- Helps reduce foaming due to temperature increase of beer
- Slotted top for pump/coupler access
- Durable treated canvas inside and out with heavy insulation

Catalog No.	10+	5+	Each
15H01-102	39.95	40.95	42.95



1/6 Barrel American Sanke Keg

FOR OVER 20 YEARS A.E.B. HAS BEEN A WORLD LEADER IN THE PRODUCTION OF STAINLESS STEEL KEGS AND PRODUCT TANKS



MADE IN ITALY



American Sanke Fitment 5.16 gallon capacity

- Body is 304 stainless steel
- Chimes are 304 stainless steel
- Sanitary robotic welded seams free from any deposit of material
- Pasivated, washed and sanitized
- Each keg is etched with A.E.B. logo, Made in Italy, serial number and manufactured date
- Stamped with all compliant warnings
- 9" diameter x 23.25" height
- Weight is 13.5 lbs.



LARGER VOLUME QUOTES AVAILABLE UPON REQUEST

Keg Bumper

RHINO-TOUGH – PROTECTS CONTAINER AND FLOOR

TRUSTED FOR OVER 50 YEARS

- Tough, heavy-duty rubber construction, made in USA
- Waterproof and built to last
- Absorbs impact of keg drop
- 21 lbs., 18" dia. x 4.5" thick



15C07-301

50+ **\$75.95**

25+ **\$78.95** 10+ **\$81.95**

5+ **\$84.95** Ea. **\$89.95**

20L02-114 Ea. **\$79.95**



Galvanized or Stainless Steel Keg Racks

HEAVY DUTY 1 1/2" SQUARE TUBING • 10 YEAR MANUFACTURER PRORATED WARRANTY

SHIPS DIRECTLY FROM THE MANUFACTURER IN DETROIT, MI VIA TRUCK LINE ONLY



5 & 6 keg racks have additional support leg

ALL RACKS
ALL TOP SHELVES
33" Height
16" Deep

5 & 6 KEG

4 KEG

3 KEG

2 KEG



STAINLESS STEEL MODELS



MIX AND MATCH SIZES TO FIT YOUR WALK-IN • EACH RACK STORES THE SAME QUANTITY ABOVE AND BELOW TOP SHELVES (NOT PICTURED) ARE FOR CASE BEER AND WINE STORAGE



GALVANIZED - KEG RACK

Catalog No.	Kegs	Length	Each
15L01-100	2	44"	542.00
15L01-101	3	66"	636.00
15L01-102	4	75"	718.00
15L01-103	5	95"	871.00
15L01-104	6	108"	930.00

GALVANIZED - TOP SHELF

Catalog No.	Length	Each
15L01-200	44"	242.00
15L01-201	66"	271.00
15L01-202	75"	306.00
15L01-203	95"	348.00
15L01-204	108"	377.00

NSF S/S - KEG RACK

Catalog No.	Kegs	Length	Each
15L01-105	2	44"	689.00
15L01-106	3	66"	818.00
15L01-107	4	75"	924.00
15L01-108	5	95"	1077.00
15L01-109	6	108"	1148.00

NSF S/S - TOP SHELF

Catalog No.	Length	Each
15L01-205	44"	283.00
15L01-206	66"	330.00
15L01-207	75"	365.00
15L01-208	95"	412.00
15L01-209	108"	436.00



Keg Stacker Rings

PERFECT FOR INCREASING COOLER STORAGE SPACE • ALSO USE TO STACK KEGS DURING DELIVERY



1/2 BARREL



NO MORE THAN
TWO KEGS PER STACK

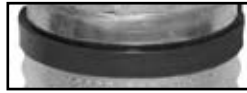

1/6 BARREL

Catalog No.	Description	10+	5+	Each
20S02-100	1/2 Barrel	18.95	19.95	20.95

Catalog No.	Description	10+	5+	Each
20S02-103	1/6 Barrel	19.95	20.95	21.95

Keg Spacer/Stacker Ring

ALLOWS LOWER KEG TO BE TAPPED • PERFECT FOR INCREASING COOLER STORAGE SPACE



1/2 BARREL



NO MORE THAN
TWO KEGS
PER STACK



1/6 BARREL

Catalog No.	Description	14+	7+	Each
20S02-101	1/2 Barrel	23.95	24.95	25.95

Catalog No.	Description	8+	4+	Each
20S02-104	1/6 Barrel	32.95	33.95	34.95

Adapter Ring and Keg Dollies

USE ADAPTER WITH SPACERS/STACKERS • ALLOWS KEGS TO BE MOVED EASILY FOR CLEANING/RELOCATION



STACK A 1/6 BARREL
OR 1/4 SLIM ON TOP OF
A 1/2 OR 1/4 BARREL

ADAPTER RING



1/6 BARREL



500 LB.
LIMIT ON ALL
DOLLIES

1/2 BARREL

Catalog No.	Description	10+	5+	Each
20S02-102	Adapter Ring	15.95	16.95	17.95

Catalog No.	Description	8+	4+	Each
20S02-106	1/6 Barrel Dolly	23.95	24.95	25.95

Catalog No.	Description	8+	4+	Each
20S02-105	1/2 Barrel Dolly	24.95	25.95	26.95

Keg Stacker Rings

PERFECT FOR INCREASING COOLER STORAGE SPACE • ALSO USE TO STACK KEGS DURING DELIVERY



1/6 BARREL



1/2 BARREL



Catalog No.	Description	6+	3+	Each
20L02-116	1/6 Barrel	20.95	21.95	22.95

Catalog No.	Description	10+	5+	Each
20L02-111	1/2 Barrel	20.95	21.95	22.95

Keg Spacer/Stacker Ring

ALLOWS LOWER KEG TO BE TAPPED • PERFECT FOR INCREASING COOLER STORAGE SPACE

NO MORE THAN TWO KEGS PER STACK

20L02-110

12+ **\$24.95**

6+ **\$25.95**

Ea. **\$26.95**



1/2 BARREL

Case and Keg Dollies

ALLOWS KEGS/CASES TO BE MOVED EASILY FOR CLEANING/RELOCATION • USE WITH SPACERS/STACKERS



CASE BEER

500 LB. LIMIT ON ALL DOLLIES



1/6 BARREL



1/2 BARREL

Catalog No.	Description	8+	4+	Each
20L02-115	Case Dolly			
30.95		31.95		33.95

Catalog No.	Description	8+	4+	Each
20L02-117	1/6 Barrel Dolly			
27.95		28.95		29.95

Catalog No.	Description	8+	4+	Each
20L02-112	1/2 Barrel Dolly			
32.95		33.95		35.95

Keg Space Management Products

Aston Beer Engines

MASONS IS A LEADING UK MANUFACTURER OF BEER DISPENSERS, PROVIDING QUALITY AND RELIABLE DISPENSING EQUIPMENT



HAS A SELF-CONTAINED WATER JACKET TO KEEP BEER IN CYLINDER COLD



Solid Wood Plinth

1/4 Pint Pull

The Masons *Aston* Clamp-On Beer Engine has been designed for cask conditioned beers, by the oldest manufacturer of beer dispense equipment in the UK. The combined years of Masons / Gaskell and Chambers experience has resulted in this sturdy, reliable and most attractive dispense unit.

22H01-100
1/4 PINT PULL

\$395.00

22H01-123
REPLACEMENT CYLINDER

\$146.95

Cask Taps

- 3/8" Barbed end for connection to beer engine
- 1/4 turn wing handle for off/on
- Includes a S/S hop filter (installed)
- 3/4" BSP thread for nut/tailpiece



Catalog No.	Description	6+	3+	Each
22H01-104	Cask Tap, Single (3/8" Barb)	23.95	25.95	27.95

- Same basic features as the single tap, but will service two beer engines from one cask
- Has two individual 1/4 turn wing handle shutoffs so either one or both can be open at the same time



Catalog No.	Description	6+	3+	Each
22H01-106	Cask Tap, Double (3/8" Barbs)	25.95	27.95	29.95

POUR DIRECTLY FROM CASK

- S/S pour spout
- 1/4 turn wing handle for off/on
- Includes a S/S hop filter (installed)
- 3/4" BSP thread for nut/tailpiece



Catalog No.	Description	6+	3+	Each
22H01-105	Cask Tap, Single (S/S Pour Spout)	27.95	28.95	30.95

Masons Replacement Tips



Slotted Tip (standard) for Masons



Sparkler Tip 0.6 mm holes for Masons

Catalog No.	Description	10+	5+	Each
22H01-103	Slotted Tip (Masons)	1.95	2.50	2.95
22H01-102	Sparkler Tip .6 mm holes (Masons)	2.95	3.50	3.95

Cask Equipment

Cask Tap Accessories



Ref.	Catalog No.	Description	10+	5+	Each
1	22H01-107	Wing Nut 3/4" BSP (Plastic)	1.50	1.75	1.95
2	22H01-116	Hop Filter 3/4" BSP (S/S)	1.05	1.15	1.25

Ref.	Catalog No.	Description	10+	5+	Each
3	22H01-122	Tailpiece 3/4" BSP (3/8" Barb)	1.15	1.25	1.35
4	22H01-121	Turndown Spout 3/4" BSP (1/2")	8.95	9.50	9.95

Tapping Accessories



Ref.	Catalog No.	Description	25+	10+	Each
1	22H01-109	Keystone (Wooden)	0.65	0.70	0.75
2	22H01-110	Keystone (Plastic)	0.65	0.70	0.75

Ref.	Catalog No.	Description	25+	10+	Each
3	22H01-115	Keystone Plug (Cork)	0.13	0.14	0.15
4	22H01-119	Check Valve 3/8" OD x 1/2" Barb	-	-	37.95

Cask Breathing (O₂) Accessories



Ref.	Catalog No.	Description	25+	10+	Each
1	22H01-111	Shive (Wooden)	0.90	0.95	1.00
2	22H01-112	Shive (Plastic)	0.80	0.90	1.00
3	22H01-113	Spile (Soft Wood)	0.35	0.40	0.45

Ref.	Catalog No.	Description	25+	10+	Each
4	22H01-114	Spile (Hard Wood)	0.30	0.35	0.40
Ref.	Catalog No.	Description	10+	5+	Each
5	22H01-120	Cask Breather for Air (Autovent)	15.95	16.95	17.95

Cask Breathing (CO₂) Accessories

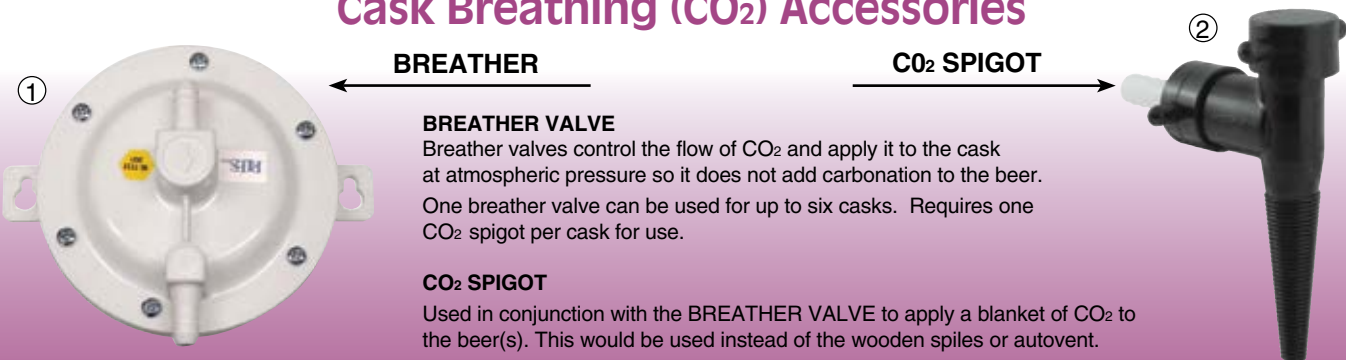

BREATHER

CO₂ SPIGOT

BREATHER VALVE

Breather valves control the flow of CO₂ and apply it to the cask at atmospheric pressure so it does not add carbonation to the beer. One breather valve can be used for up to six casks. Requires one CO₂ spigot per cask for use.

CO₂ SPIGOT

Used in conjunction with the BREATHER VALVE to apply a blanket of CO₂ to the beer(s). This would be used instead of the wooden spiles or autovent.

Ref.	Catalog No.	Description	6+	3+	Each
1	22H01-117	CO ₂ Breather Valve 3/8" Barbs	95.95	99.95	105.95

Ref.	Catalog No.	Description	6+	3+	Each
2	22H01-118	CO ₂ Breather Spigot 3/8" Barb	15.95	16.95	17.95

Cask Equipment

3-Position Butterfly Valve

TRI-CLOVER COMPATIBLE



- Pull lever lock, can be set to 3 different positions
- Can be cleaned in place
- No pockets for particles to hide
- Recommended for use on vessel outlets & fermenters

Catalog No.	Description	6+	3+	Each
21B09-510	(1") 3-Position Butterfly Valve	48.95	51.95	54.95
21B09-221	(1.5") 3-Position Butterfly Valve	50.95	53.95	58.95
21B09-511	(2") 3-Position Butterfly Valve	60.95	63.95	68.95

13-Position Butterfly Valve

TRI-CLOVER COMPATIBLE



- Squeeze lever lock, can be set to 13 different positions
- Can be cleaned in place
- No pockets for particles to hide
- Recommended for use on vessel outlets & fermenters

Catalog No.	Description	6+	3+	Each
21B09-300	(1") 13-Position Butterfly Valve	48.95	50.95	52.95
21B09-301	(1.5") 13-Position Butterfly Valve	49.95	51.95	53.95
21B09-302	(2") 13-Position Butterfly Valve	58.95	61.95	64.95

Economy Ball Valve

TRI-CLOVER COMPATIBLE



- 1/4 turn from Off to On and offers more control over the flow than butterfly type valves
- Can be cleaned in place
- No pockets for particles to hide
- Recommended for use on vessel outlets and fermenters

Catalog No.	Description	6+	3+	Each
21B09-570	(.75") 13-Position Ball Valve	30.95	32.95	34.95
21B09-571	(1") 13-Position Ball Valve	27.95	29.95	31.95
21B09-572	(1.5") 13-Position Ball Valve	36.95	38.95	40.95
21B09-573	(2") Economy Ball Valve	52.95	55.95	58.95

13-Position Butterfly Valve

TRI-CLOVER COMPATIBLE



- Squeeze lever lock, can be set to 13 different positions
- Can be cleaned in place
- No pockets for particles to hide
- Recommended for use on vessel outlets and fermenters

Catalog No.	Description	6+	3+	Each
21B09-580	(1") 13-Position Ball Valve	51.95	53.95	55.95
21B09-581	(1.5") 13-Position Ball Valve	54.95	56.95	58.95
21B09-582	(2") 13-Position Ball Valve	61.95	64.95	67.95

Additional price breaks available on most items. Login to your website account or contact your sales representative for pricing.

Quick-Clean Ball Valves

TRI-CLOVER COMPATIBLE



- 1/4 turn from Off to On and offers more control over the flow than butterfly type valves
- Breaks down in about 30 seconds for cleaning (no tools required)
- No pockets for particles to hide
- Recommended for use on pump outlets and vessel returns

Catalog No.	Description	6+	3+	Each
21B09-310	(.75") Quick Clean Ball Valve	38.95	40.95	43.95
21B09-311	(1") Quick Clean Ball Valve	40.95	42.95	45.95
21B09-312	(1.5") Quick Clean Ball Valve	48.95	51.95	54.95
21B09-313	(2") Quick Clean Ball Valve	69.95	72.95	76.95

3-Piece Ball Valves

TRI-CLOVER COMPATIBLE



- 1/4 turn from Off to On and offers more control over the flow than butterfly type valves
- Traditional 3 pc construction held together with 4 bolts
- No pockets for particles to hide
- Recommended for use on vessel outlets and fermenters

Catalog No.	Description	6+	3+	Each
21B09-490	(1") 3-Piece Ball Valve	39.95	41.95	43.95
21B09-491	(1.5") 3-Piece Ball Valve	64.95	67.95	69.95

Tri-Clover Compatible Fittings



3-Way Ball Valve

TRI-CLOVER COMPATIBLE

- Ball has passageways in a "T" pattern offering up to four different flow patterns AB, ABC, AC, BC
- Can be cleaned in place using the ABC position
- Recommended for use in place of tees where the control of multiple flow directions is required

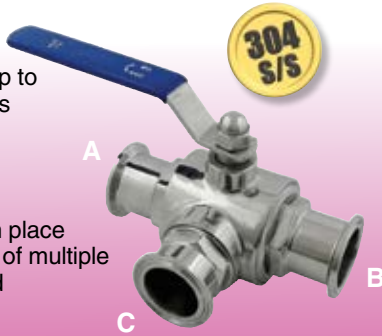

Catalog No.	Description	6+	3+	Each
21B09-320	(.75") 3-Way Ball Valve	50.95	53.95	56.95
21B09-321	(1") 3-Way Ball Valve	50.95	53.95	56.95
21B09-322	(1.5") 3-Way Ball Valve	60.95	63.95	66.95

Back Check Valve

TRI-CLOVER COMPATIBLE

- Easily attach, remove or replace as desired
- Disassembly for cleaning and seal replacement is easy to do
- For use with commercial transfer pump to prevent back flow of liquid



NOT FOR USE WITH MARCH OR CHUGGER PUMPS

Catalog No.	Description	6+	3+	Each
21B09-390	(1") Back Check Valve	-	-	49.95
21B09-391	(1.5") Back Check Valve	-	49.95	52.95
21B09-392	(2") Back Check Valve	-	-	61.95

Diaphragm 3-Way Valve

TRI-CLOVER COMPATIBLE

- Manufactured of 316 S/S
- Dual gaskets EPDM and PTFE
- Easily disassembles for gasket replacement and cleaning
- Recommended for use where precise control over fluid flow is required



Catalog No.	Description	6+	3+	Each
21B09-620	(1") 3-Way Diaphragm Valve	-	-	191.95
21B09-621	(1.5") 3-Way Diaphragm Valve	-	-	270.95

Diaphragm Valve

TRI-CLOVER COMPATIBLE

- Manufactured of 316 S/S
- Dual gaskets EPDM and PTFE
- Easily disassembles for gasket replacement and cleaning
- Recommended for use where precise control over fluid flow is required



Catalog No.	Description	6+	3+	Each
21B09-590	(.75") Diaphragm Valve	76.95	80.95	85.95
21B09-591	(1") Diaphragm Valve	92.95	97.95	103.95
21B09-592	(1.5") Diaphragm Valve	112.95	118.95	124.95
21B09-593	(2") Diaphragm Valve	138.95	145.95	153.95

Additional price breaks available on most items. Login to your website account or contact your sales representative for pricing.

360° View Sight Glass

TRI-CLOVER COMPATIBLE

- Provides full 360° viewing of flowing liquid
- Easily disassembles for seal, glass replacement and cleaning
- No pockets for particles to hide
- Recommended for use where visual monitoring is beneficial to production



Catalog No.	Description	6+	3+	Each
21B09-246	(.75") 360° Sight Glass	47.95	49.95	51.95
21B09-247	(1") 360° Sight Glass	47.95	49.95	51.95
21B09-248	(1.5") 360° Sight Glass	49.95	51.95	54.95
21B09-249	(2") 360° Sight Glass	59.95	62.95	65.95

Process Sight Glass

TRI-CLOVER COMPATIBLE

- Provides direct view of liquid in a vessel or flowing
- Easily disassembles for seal replacement and cleaning
- Recommended for use on vessels to look inside and view process or attach to a tee for view of flowing liquid



Catalog No.	Description	6+	3+	Each
21B09-690	(1.5") Process Sight Glass	31.95	33.95	35.95
21B09-691	(2") Process Sight Glass	33.95	35.95	37.95

Tri-Clover Compatible Fittings

Standard Tees

TRI-CLOVER COMPATIBLE



- Factory welded and polished inside and out to provide an easy-to-clean component
- Recommended for use when hard piping short sections of your brewery

Catalog No.	Description	6+	3+	Each
21B09-332	(1") Standard Tee	17.95	18.95	19.95
21B09-333	(1.5") Standard Tee	19.95	20.95	21.95
21B09-334	(2") Standard Tee	24.95	25.95	26.95

Reducing Tees

TRI-CLOVER COMPATIBLE



- Factory welded and polished inside and out to provide an easy-to-clean component
- Recommended for use when hard piping short sections of your brewery

Catalog No.	Description	6+	3+	Each
21B09-340	(1.5" x 1") Reducing Tee	20.95	21.95	22.95
21B09-341	(2" x 1") Reducing Tee	24.95	25.95	26.95
21B09-342	(2" x 1.5") Reducing Tee	24.95	25.95	26.95

Instrument Tees

TRI-CLOVER COMPATIBLE



- Factory welded and polished inside and out to provide an easy-to-clean component
- Recommended for use when hard piping short sections of your brewery

Catalog No.	Description	6+	3+	Each
21B09-500	(1") Instrument Tee	19.95	20.95	21.95
21B09-501	(1.5") Instrument Tee	20.95	21.95	22.95
21B09-502	(2") Instrument Tee	24.95	25.95	26.95

Standard Crosses

TRI-CLOVER COMPATIBLE



- Factory welded and polished inside and out to provide an easy-to-clean component
- Recommended for use when hard piping short sections of your brewery

Catalog No.	Description	6+	3+	Each
21B09-401	(1") Standard Cross	26.95	27.95	28.95
21B09-402	(1.5") Standard Cross	27.95	28.95	29.95
21B09-403	(2") Standard Cross	-	-	38.95

Not seeing the configuration you want? Contact your sales representative for pricing and availability on what you do want.

Extension Tubes

TRI-CLOVER COMPATIBLE



FROM
6" - 36" LENGTH
AVAILABLE

- Factory welded and polished inside and out to provide a smooth leak-free component
- Smooth interior is easy to clean
- Recommended for use when hard piping short sections of your brewery

Catalog No.	Description	6+	3+	Each
21B09-370	6" Length (1") Extension Tube	19.95	20.95	21.95
21B09-371	12" Length (1") Extension Tube	23.95	24.95	25.95
21B09-372	18" Length (1") Extension Tube	29.95	31.95	32.95
21B09-373	24" Length (1") Extension Tube	33.95	35.95	37.95
21B09-374	36" Length (1") Extension Tube	40.95	42.95	44.95
21B09-375	6" Length (1.5") Extension Tube	21.95	22.95	23.95
21B09-376	12" Length (1.5") Extension Tube	24.95	25.95	26.95
21B09-377	18" Length (1.5") Extension Tube	30.95	32.95	34.95
21B09-378	24" Length (1.5") Extension Tube	34.95	36.95	39.95
21B09-379	36" Length (1.5") Extension Tube	41.95	44.95	46.95
21B09-380	6" Length (2") Extension Tube	-	-	29.95
21B09-381	12" Length (2") Extension Tube	-	-	33.95
21B09-382	18" Length (2") Extension Tube	-	-	42.95
21B09-383	24" Length (2") Extension Tube	-	-	49.95
21B09-384	36" Length (2") Extension Tube	-	-	59.95
21B09-385	12" Length (3") Extension Tube	-	-	41.95
21B09-386	18" Length (3") Extension Tube	-	-	49.95
21B09-387	24" Length (3") Extension Tube	-	-	54.95
21B09-388	36" Length (3") Extension Tube	-	-	59.95

Tri-Clover Compatible Fittings



Elbowed Tubes

TRI-CLOVER COMPATIBLE

90° ANGLED ELBOW

Catalog No.	Description	6+	3+	Each
21B09-350	(.5") 90° Elbow	17.95	18.95	19.95
21B09-351	(.75") 90° Elbow	17.95	18.95	19.95
21B09-352	(1") 90° Elbow	12.95	13.95	14.95
21B09-353	(1.5") 90° Elbow	15.95	16.95	17.95
21B09-354	(2") 90° Elbow	19.95	20.95	21.95
21B09-355	(3") 90° Elbow	28.95	30.95	32.95

45° ANGLED ELBOW

Catalog No.	Description	6+	3+	Each
21B09-360	(.75") 45° Elbow	17.95	18.95	19.95
21B09-361	(1") 45° Elbow	11.95	12.95	13.95
21B09-362	(1.5") 45° Elbow	12.95	13.95	14.95
21B09-363	(2") 45° Elbow	14.95	15.95	16.95

- Factory welded and polished inside and out to provide an easy-to-clean component
- Available in either 45° or 90° angles to provide a multitude of configurations when combined with extension tubes and other fittings
- Recommended for use when hard piping short sections of your brewery



90°



45°

180° U-Bend Tubes

TRI-CLOVER COMPATIBLE

- Factory welded and polished inside and out to provide an easy-to-clean component
- Provides a multitude of configurations when combined with extension tubes and other fittings
- Recommended for use when hard piping short sections of your brewery



Catalog No.	Description	6+	3+	Each
21B09-660	(1") 180° U-Bend Tube	32.95	34.95	36.95
21B09-661	(1.5") 180° U-Bend Tube	34.95	36.95	38.95

135° "Y" Tees

TRI-CLOVER COMPATIBLE

- Factory welded and polished inside and out to provide an easy-to-clean component
- Provides a multitude of configurations when combined with extension tubes and other fittings
- Recommended for use when hard piping short sections of your brewery



90°



Catalog No.	Description	6+	3+	Each
21B09-670	(1") 135° "Y" Tee Tube	33.95	35.95	37.95
21B09-671	(1.5") 135° "Y" Tee Tube	37.95	39.95	41.95
21B09-672	(2") 135° "Y" Tee Tube	42.95	45.95	48.95

90° "Y" Tees

TRI-CLOVER COMPATIBLE

- Factory welded and polished inside and out to provide an easy-to-clean component
- Provides a multitude of configurations when combined with extension tubes and other fittings
- Recommended for use when hard piping short sections of your brewery



Catalog No.	Description	6+	3+	Each
21B09-680	(1") 90° "Y" Tee Tube	29.95	31.95	33.95
21B09-681	(1.5") 90° "Y" Tee Tube	33.95	35.95	37.95
21B09-682	(2") 90° "Y" Tee Tube	42.95	44.95	46.95

PRV Tank Breathers

TRI-CLOVER COMPATIBLE

- Easily attach, remove or replace as desired
- Does not need to be removed or disassembled for cleaning. Entire breather can be soaked and rinsed if desired
- Recommended for use to control tank pressure and breaks vacuum at 1.5 PSI



Catalog No.	Description	6+	3+	Each
21B09-460	(1.5") 15-PSI Tank Breather	-	105.95	109.95
21B09-461	(1.5") 30-PSI Tank Breather	-	105.95	109.95

Tri-Clover Compatible Fittings

Wing Nut Clamps TRI-CLOVER COMPATIBLE

- High quality clamps made from 304 stainless steel are durable and have superior corrosion resistance
- Used with a gasket and two tri-clamp flanges to create a leak-free connection



Catalog No.	Description	10+	5+	Each
21B09-209	(.5"/.75") Wing Nut Clamp	6.95	7.50	7.95
21B09-208	(1"/1.5") Wing Nut Clamp	7.95	8.95	9.95
21B09-200	(2") Wing Nut Clamp	7.50	7.95	8.95
21B09-201	(3") Wing Nut Clamp	8.95	9.95	10.95

Catalog No.	Description	10+	5+	Each
21B09-202	(4") Wing Nut Clamp	10.50	10.95	11.95
21B09-203	(6") Wing Nut Clamp	25.95	26.95	28.95
21B09-204	(8") Wing Nut Clamp	35.95	36.95	38.95
-	-	-	-	-



Concentric Reducers TRI-CLOVER COMPATIBLE

TRI-CLOVER COMPATIBLE

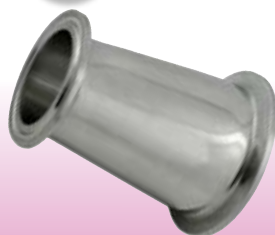

- Factory welded & polished inside and out to provide an easy to clean component
- Recommended for use to downsize tubes and still maintain a sanitary fitment that can be cleaned in place



Eccentric Reducers TRI-CLOVER COMPATIBLE

TRI-CLOVER COMPATIBLE



- Factory welded & polished inside and out to provide an easy to clean component
- Recommended for use to downsizing tubes without trapping liquid on a horizontal run. Sanitary and clean in place

Catalog No.	Description	6+	3+	Each
21B09-410	(1" x .5") Concentric Reducer	16.95	17.95	18.95
21B09-411	(1" x .75") Concentric Reducer	16.95	17.95	18.95
21B09-412	(1.5" x 1") Concentric Reducer	15.95	16.95	17.95
21B09-413	(2" x 1") Concentric Reducer	16.95	17.95	18.95
21B09-414	(2" x 1.5") Concentric Reducer	16.95	17.95	18.95
21B09-417	(3" x 1.5") Concentric Reducer	22.95	23.95	24.95
21B09-418	(3" x 2") Concentric Reducer	22.95	23.95	24.95

Catalog No.	Description	6+	3+	Each
21B09-420	(1.5" x 1") Eccentric Reducer	18.95	19.95	20.95
21B09-421	(2" x 1") Eccentric Reducer	18.95	19.95	20.95
21B09-422	(2" x 1.5") Eccentric Reducer	19.95	20.95	21.95
21B09-423	(3" x 1.5") Eccentric Reducer	22.95	23.95	24.95
21B09-424	(3" x 2") Eccentric Reducer	22.95	23.95	24.95
21B09-425	(4" x 2") Eccentric Reducer	-	-	47.95
21B09-426	(4" x 3") Eccentric Reducer	-	-	40.95

Additional price breaks available on most items. Login to your website account or contact your sales representative for pricing.

Cap Style Reducers TRI-CLOVER COMPATIBLE

CENTERED



OFFSET

- Factory welded and polished inside and out to provide a smooth leak-free component
- Recommended for use when a quick interchange of flange sizes are required. Technically this is not a sanitary fitting due to the abrupt change and cannot be cleaned in place
- The centered version works best for vertical drops and the offset would be used mainly on horizontal runs to help maximize drainage of liquid

Catalog No.	Description	6+	3+	Each
21B09-431	(1.5" x .75") Centered Cap Reducer	12.95	13.50	13.95
21B09-214	(1.5" x 1") Centered Cap Reducer	11.95	12.50	12.95
21B09-432	(2" x 1.5") Centered Cap Reducer	14.95	15.95	16.95
21B09-433	(3" x 1") Centered Cap Reducer	19.95	20.95	21.95
21B09-434	(3" x 1.5") Centered Cap Reducer	19.95	20.95	21.95
21B09-435	(3" x 2") Centered Cap Reducer	19.95	20.95	21.95
21B09-436	(4" x 2") Centered Cap Reducer	22.95	23.95	24.95
21B09-437	(4" x 3") Centered Cap Reducer	23.95	24.95	25.95
21B09-438	(6" x 1.5") Centered Cap Reducer	30.95	31.95	32.95
21B09-439	(6" x 2") Centered Cap Reducer	-	-	38.95
21B09-440	(6" x 3") Centered Cap Reducer	-	-	38.95
21B09-443	(2" x 1.5") Offset Cap Reducer	14.95	15.95	16.95
21B09-444	(3" x 1") Offset Cap Reducer	20.95	21.95	22.95
21B09-445	(4" x 1.5") Offset Cap Reducer	22.95	23.95	24.95

Tri-Clover Compatible Fittings



- High quality clamps made from 304 stainless steel are durable and have superior corrosion resistance
- Available in standard length or XL 4" length

Barbed Fittings

TRI-CLOVER COMPATIBLE



Catalog No.	Description	10+	5+	Each
21B09-450	(1"/1.5" x 1/4" Barb) Standard	12.95	13.95	14.95
21B09-452	(1"/1.5" x 5/16" Barb) Standard	13.95	14.95	15.95
21B09-245	(1"/1.5" x 3/8" Barb) Standard	13.95	14.95	15.95
21B09-217	(1"/1.5" x 1/2" Barb) Standard	13.95	14.95	15.95
21B09-229	(1"/1.5" x 5/8" Barb) Standard	14.95	15.95	16.95
21B09-218	(1"/1.5" x 3/4" Barb) Standard	13.95	14.95	15.95
21B09-219	(1"/1.5" x 1" Barb) Standard	14.95	15.95	16.95

Catalog No.	Description	10+	5+	Each
21B09-220	(1"/1.5" x 1.5" Barb) Standard	15.95	16.95	17.95
21B09-453	(2" x 1/2" Barb) Standard	14.95	15.95	16.95
21B09-454	(2" x 3/4" Barb) Standard	14.95	15.95	16.95
21B09-455	(2" x 1" Barb) Standard	17.95	18.95	19.95
21B09-230	(1"/1.5" x 1" Barb) 4" Length	19.95	20.95	21.95
21B09-231	(1"/1.5" x 1.5" Barb) 4" Length	19.95	20.95	21.95
21B09-456	(2" x 2" Barb) 4" Length	21.95	22.95	23.95

Sanitary Cap Fittings

TRI-CLOVER COMPATIBLE



- High quality fittings made from 304 stainless steel are durable and have superior corrosion resistance
- Used for capping off valves or any opening to keep it in sanitary condition



Catalog No.	Description	10+	5+	Each
21B09-215	(.5"- .75") Sanitary Cap	4.95	5.50	5.95
21B09-216	(1"/1.5") Sanitary Cap	2.95	3.50	3.95
21B09-224	(2") Sanitary Cap	4.50	4.95	5.95
21B09-225	(3") Sanitary Cap	6.95	7.50	7.95
21B09-226	(4") Sanitary Cap	10.95	11.50	11.95
21B09-227	(6") Sanitary Cap	-	-	31.95
21B09-228	(8") Sanitary Cap	-	-	49.95

90° Elbow Barbed Fittings

TRI-CLOVER COMPATIBLE



- High quality fittings made from 304 stainless steel are durable and have superior corrosion resistance
- Ideal for use in locations where sharp angle in hose placement is required to complete connection



Catalog No.	Description	10+	5+	Each
21B09-457	(1"/1.5" x 3/8" Barb) 90° Elbow	13.95	14.95	15.95
21B09-232	(1"/1.5" x 1/2" Barb) 90° Elbow	14.95	15.95	16.95
21B09-233	(1"/1.5" x 5/8" Barb) 90° Elbow	14.95	15.95	16.95
21B09-234	(1"/1.5" x 3/4" Barb) 90° Elbow	15.95	16.95	17.95
21B09-235	(1"/1.5" x 1" Barb) 90° Elbow	16.95	17.95	18.95

Male Thread Fittings

TRI-CLOVER COMPATIBLE



- High quality fittings made from 304 stainless steel are durable and have superior corrosion resistance
- Used for introducing female threaded components into the tri-clamp system



Catalog No.	Description	10+	5+	Each
21B09-222	(1"/1.5") Male Beer Thread	20.95	21.95	22.95
21B09-251	(1"/1.5") 1/4" Male Pipe Thread	11.95	12.95	13.95
21B09-241	(1"/1.5") 3/8" Male Pipe Thread	15.95	16.95	17.95
21B09-242	(1"/1.5") 1/2" Male Pipe Thread	10.95	11.50	11.95
21B09-243	(1"/1.5") 3/4" Male Pipe Thread	12.95	13.50	13.95
21B09-244	(1"/1.5") 1" Male Pipe Thread	15.95	16.95	17.95

Female Thread Fittings

TRI-CLOVER COMPATIBLE



- High quality fittings made from 304 stainless steel are durable and have superior corrosion resistance
- Used for introducing male threaded components into the tri-clamp system



Catalog No.	Description	10+	5+	Each
21B09-223	(1"/1.5") Female Beer Thread	18.95	19.95	20.95
21B09-236	(1"/1.5") 1/4" Male Pipe Thread	12.95	13.95	14.95
21B09-237	(1"/1.5") 3/8" Female Pipe Thread	15.95	16.95	17.95
21B09-238	(1"/1.5") 1/2" Female Pipe Thread	13.95	14.95	15.95
21B09-239	(1"/1.5") 3/4" Female Pipe Thread	14.95	15.95	16.95
21B09-240	(1"/1.5") 1" Female Pipe Thread	18.95	19.95	20.95

Tri-Clover Compatible Fittings

Drop-In Thermowells

TRI-CLOVER COMPATIBLE



- Easily attaches to any 1.5" flange
- Used with drop-in style thermometers for temporary placement
- Recommended for use where an internal temperature reading inside of a vessel is required

Catalog No.	Description	6+	3+	Each
21B09-520	(1.5") 3" Length Drop-In	21.95	22.95	23.95
21B09-521	(1.5") 6" Length Drop-In	23.95	24.95	25.95
21B09-522	(1.5") 12" Length Drop-In	24.95	25.95	26.95
21B09-523	(1.5") 16" Length Drop-In	27.95	29.95	31.95
21B09-524	(1.5") 20" Length Drop-In	27.95	29.95	31.95
21B09-525	(1.5") 24" Length Drop-In	32.95	34.95	36.95

Thread-In Thermowells

TRI-CLOVER COMPATIBLE



- Easily attaches to any 1.5" flange
- Used with thread-in style thermometers for more secure semi-permanent placement
- Recommended for use where an internal temperature reading inside of a vessel is required

Catalog No.	Description	6+	3+	Each
21B09-530	(1.5") 4" Length Thread-In	28.95	30.95	32.95
21B09-531	(1.5") 6" Length Thread-In	28.95	30.95	32.95
21B09-532	(1.5") 12" Length Thread-In	30.95	32.95	34.95
21B09-533	(1.5") 20" Length Thread-In	36.95	38.95	40.95

Pressure Gauges

TRI-CLOVER COMPATIBLE

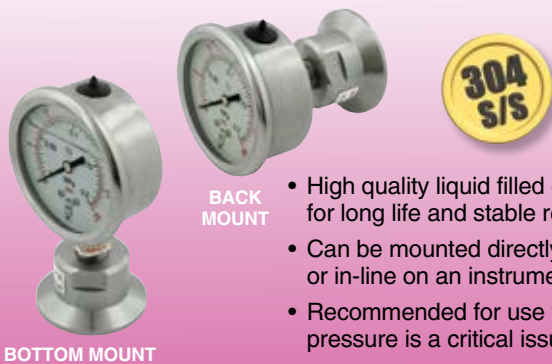

BACK MOUNT

- High quality liquid filled gauge for long life and stable readings
- Can be mounted directly to tank or in-line on an instrument tee
- Recommended for use where pressure is a critical issue

BOTTOM MOUNT

Catalog No.	Description	6+	3+	Each
21B09-470	(1.5") 30-PSI Bottom Mount	43.95	45.95	47.95
21B09-471	(1.5") 60-PSI Bottom Mount	43.95	45.95	47.95
21B09-472	(1.5") 30-PSI Back Mount	43.95	45.95	47.95
21B09-473	(1.5") 60-PSI Back Mount	43.95	45.95	47.95

Inside/Outside Fittings

TRI-CLOVER COMPATIBLE



21B09-544

21B09-540

21B09-543

21B09-542

- Machined from one solid piece of 304 S/S - not welded together
- Mounts directly to any 1.5" flange
- Recommended for use where it is necessary to have additional connectivity inside the vessel for carb stones, cleaning balls, etc.

Catalog No.	Description	6+	3+	Each
21B09-540	(1.5") 1/4" FFL-In x 1/4" MFL-Out	23.95	25.95	27.95
21B09-541	(1.5") 1/2" FPT-In x 1/2" MPT-Out	23.95	25.95	27.95
21B09-542	(1.5") 1/2" MPT-In x 1/2" MPT-Out	23.95	25.95	27.95
21B09-543	(1.5") 1/2" MPT-In x 1/2" FPT-Out	23.95	25.95	27.95
21B09-544	(1.5") 1/2" FPT-In x 1/2" FPT-Out	23.95	25.95	27.95

Garden Hose Fittings

TRI-CLOVER COMPATIBLE



- High quality fittings are durable and have superior corrosion resistance – made of 304 S/S
- Washer not included with purchase of either fitting
- Recommended for use where adding water to a vessel via a garden hose is required

Catalog No.	Description	6+	3+	Each
21B09-550	(1.5") Male GH Thread	15.95	16.95	17.95
21B09-551	(1.5") Female GH Thread	15.95	16.95	17.95

Flare Adapter Fittings

TRI-CLOVER COMPATIBLE



- High quality fittings are durable and have superior corrosion resistance – made of 304 S/S
- Flare washer not included with purchase of either fitting
- Recommended for use where a removable small hose connection to vessels is required

Catalog No.	Description	6+	3+	Each
21B09-560	(1.5") 1/4" MFL Adapter	15.95	16.95	17.95
21B09-561	(1.5") 1/4" FFL Adapter	15.95	16.95	17.95

Tri-Clover Compatible Fittings



Weld-In-Place Flanges

TRI-CLOVER COMPATIBLE

Recommended for adding an access port to a vessel or lid



Catalog No.	Description	6+	3+	Each
21B09-630	(1") .5" L	3.75	3.95	4.50
21B09-631	(1") .846" L	4.25	4.50	4.95
21B09-632	(1") 1.125" L	4.25	4.50	4.95
21B09-633	(1") 1.75" L	7.25	7.50	7.95
21B09-634	(1") 3" L	10.25	10.75	11.50

Catalog No.	Description	6+	3+	Each
21B09-640	(1.5") .5" L	3.75	3.95	4.50
21B09-641	(1.5") .846" L	4.25	4.50	4.95
21B09-642	(1.5") 1.125" L	4.25	4.50	4.95
21B09-643	(1.5") 1.75" L	8.25	8.75	9.25
21B09-644	(1.5") 3" L	11.50	11.95	12.95

Catalog No.	Description	6+	3+	Each
21B09-650	(2") .5" L	4.25	4.50	4.95
21B09-651	(2") .846" L	4.50	4.95	5.50
21B09-652	(2") 1.125" L	4.95	5.50	5.95
21B09-653	(2") 1.75" L	8.95	9.50	9.95
21B09-654	(2") 3" L	13.50	13.95	14.95

Seats for Butterfly Valves

SILICONE AND EPDM AVAILABLE



Catalog No.	Description	6+	3+	Each
21B09-600	(1") Silicone Seat	5.95	6.50	6.95
21B09-601	(1.5") Silicone Seat	5.95	6.50	6.95
21B09-602	(2") Silicone Seat	5.95	6.50	6.95
21B09-610	(1") EPDM Seat	5.95	6.50	6.95
21B09-611	(1.5") EPDM Seat	5.95	6.50	6.95
21B09-612	(2") EPDM Seat	5.95	6.50	6.95

Flanged Gaskets

SILICONE AND EPDM AVAILABLE



FLANGED VS STANDARD

Catalog No.	Description	10+	5+	Each
21B09-730	(1") Silicone Flanged Gasket	1.95	2.10	2.25
21B09-731	(1.5") Silicone Flanged Gasket	1.95	2.10	2.25
21B09-732	(2") Silicone Flanged Gasket	2.10	2.25	2.50
21B09-733	(3") Silicone Flanged Gasket	3.25	3.50	3.95
21B09-740	(1") EPDM Flanged Gasket	1.30	1.40	1.50
21B09-741	(1.5") EPDM Flanged Gasket	1.30	1.40	1.50
21B09-742	(2") EPDM Flanged Gasket	1.30	1.40	1.50
21B09-743	(3") EPDM Flanged Gasket	2.25	2.50	2.75

Replacement Glass

FOR 360° SIGHT GLASS



Catalog No.	Description	6+	3+	Each
21B09-347	(1.5") 1/4" FFL x 1/4" MFL-Out	11.95	12.50	12.95
21B09-348	(1.5") 1/2" FFL x 1/2" MPT-Out	11.95	12.50	12.95
21B09-349	(1.5") 1/2" MPT x 1/2" MPT-Out	11.95	12.50	12.95

Replacement Seal Sets

FOR 360° AND PROCESS SIGHT GLASS



Catalog No.	Description	6+	3+	Each
21B09-700	(1.5") Viton for 360° Glass	6.50	6.95	7.50
21B09-701	(2") Viton for 360° Glass	6.50	6.95	7.50
21B09-710	(1.5") Silicone for 360° Glass	3.25	3.50	3.95
21B09-711	(2") Silicone for 360° Glass	4.25	4.50	4.95
21B09-720	(1.5") Viton for Process Glass	4.25	4.50	4.95
21B09-721	(2") Viton for Process Glass	4.25	4.50	4.95

Tri-Clover Compatible Fittings

FLANGED GASKETS
AVAILABLE ONLINE

Tri-Clover Compatible Gaskets

VITON GASKETS
AVAILABLE ONLINE



BUNA-N
Temp-Range
-30°F to 200°F

Chemical
Resistance
Good



EPDM
Temp-Range
-30°F to 300°F

Chemical
Resistance
Best



SILICONE
Temp-Range
-58°F to 446°F

Chemical
Resistance
Better



PTFE
Temp-Range
-100°F to 500°F

Chemical
Resistance
Best

BUNA-N TRI-CLOVER COMPATIBLE GASKETS					
Catalog No.	Size	50+	25+	10+	Each
21B09-250	1/2"	0.80	0.85	0.90	0.95
-	-	-	-	-	-
21B09-252	1"	0.65	0.70	0.75	0.80
21B09-253	1-1/2"	0.53	0.55	0.60	0.65
21B09-254	2"	0.63	0.65	0.70	0.75
21B09-255	3"	0.80	0.85	0.90	0.95
21B09-256	4"	1.30	1.35	1.45	1.50
-	6"	-	-	-	-
-	8"	-	-	-	-

SILICONE TRI-CLOVER COMPATIBLE GASKETS					
Catalog No.	Size	50+	25+	10+	Each
21B09-260	1/2"	1.55	1.65	1.75	1.85
21B09-261	3/4"	1.65	1.75	1.85	1.95
21B09-262	1"	1.05	1.10	1.15	1.20
21B09-263	1-1/2"	1.15	1.20	1.25	1.35
21B09-264	2"	1.20	1.30	1.35	1.40
21B09-265	3"	1.30	1.40	1.45	1.50
21B09-266	4"	1.55	1.65	1.75	1.85
21B09-267	6"	2.60	2.70	2.85	3.00
21B09-268	8"	4.10	4.30	4.55	4.80

EPDM TRI-CLOVER COMPATIBLE GASKETS					
Catalog No.	Size	50+	25+	10+	Each
21B09-270	1/2"	1.55	1.65	1.75	1.85
21B09-271	3/4"	1.55	1.65	1.75	1.85
21B09-272	1"	1.05	1.10	1.15	1.20
21B09-273	1-1/2"	1.15	1.20	1.25	1.30
21B09-274	2"	1.20	1.25	1.30	1.35
21B09-275	3"	1.25	1.30	1.40	1.45
21B09-276	4"	2.20	2.30	2.40	2.55
21B09-277	6"	2.60	2.70	2.85	3.00
21B09-278	8"	3.95	4.15	4.35	4.55

PTFE TRI-CLOVER COMPATIBLE GASKETS					
Catalog No.	Size	50+	25+	10+	Each
21B09-280	1/2"	0.65	0.70	0.75	0.80
21B09-281	3/4"	0.65	0.70	0.75	0.80
21B09-282	1"	1.05	1.10	1.15	1.20
21B09-283	1-1/2"	1.05	1.10	1.15	1.20
21B09-284	2"	1.45	1.50	1.60	1.70
21B09-285	3"	1.70	1.80	1.90	2.00
21B09-286	4"	2.90	3.00	3.20	3.35
21B09-287	6"	9.50	9.95	10.50	10.95
21B09-288	8"	14.95	15.95	16.95	17.95

Additional price breaks available on most items. Login to your website account or contact your sales representative for pricing.

Silcon® Silicone Tubing MANUFACTURED BY NEW AGE® INDUSTRIES

HIGH TEMPERATURE

- Able to withstand extreme temperature variations from -100°F to 500°F • Odorless, tasteless and inert
- Translucent natural color for visual contact with flow of product • Made from FDA sanctioned ingredients
- Excellent bend radius permits installation into restricted spaces without impeding flow • NSF certified

IDEAL FOR LOW PRESSURE APPLICATIONS

Catalog No.	I.D.	O.D.	Working Pressure at 70° F	Clamp Index	Roll Size	PRICES PER 100'			PRICE PER FOOT
						4 Rolls	2 Rolls	1 Roll	Under 100'
08S01-101	5/16"	1/2"	10	-	100'	91.85	96.81	99.50	1.12
08S01-102	3/8"	5/8"	10	-	100'	134.10	141.35	145.28	1.64
08S01-103	1/2"	3/4"	10	-	100'	168.94	178.07	183.02	1.94



Silbrade® Braided Silicone Tubing MANUFACTURED BY NEW AGE® INDUSTRIES

HIGH TEMPERATURE

- Able to withstand extreme temperature variations from -80°F to 350°F • Odorless, tasteless and inert
- Translucent natural color for visual contact with flow of product • Made from FDA sanctioned ingredients
- Excellent bend radius permits installation into restricted spaces without impeding flow • NSF certified

IDEAL FOR LOW PRESSURE APPLICATIONS

Catalog No.	I.D.	O.D.	Working Pressure at 70° F	Clamp Index	Roll Size	PRICES PER FOOT			
						1 Roll	50'+	25'+	Less than 25'
08S01-104	5/16"	19/32"	183 psi	-	100'	5.59	5.90	6.06	7.00
08S01-105	3/8"	21/32"	166 psi	-	100'	5.17	5.45	5.60	6.00
08S01-106	1/2"	4/5"	141 psi	-	100'	6.83	7.20	7.40	8.00



Tri-Clover Compatible Fittings





316 Grade Stainless Steel Sampling Valves



.5" TRI-CLOVER COMPATIBLE				
Catalog No.	Description	6+	3+	Each
21G09-100	Sample Valve (Black handle)	164.95	170.95	177.95
21G09-200	Sample Valve (Stainless handle)	172.95	179.95	186.95



1.5" TRI-CLOVER COMPATIBLE				
Catalog No.	Description	6+	3+	Each
21G09-101	Sample Valve (Black handle)	166.95	172.95	180.95
21G09-201	Sample Valve (Stainless handle)	174.95	181.95	188.95



1/4" MALE PIPE THREAD				
Catalog No.	Description	6+	3+	Each
21G09-140	Sample Valve (Black handle)	124.95	129.95	134.95
21G09-150	Sample Valve (Stainless handle)	132.95	137.95	143.95



3/8" MALE PIPE THREAD				
Catalog No.	Description	6+	3+	Each
21G09-141	Sample Valve (Black handle)	124.95	129.95	134.95
21G09-151	Sample Valve (Stainless handle)	132.95	137.95	143.95

Sampling Valve

TRI-CLOVER COMPATIBLE

1/2" Barb

Seal Kit

1/5" TRI-CLOVER COMPATIBLE				
Catalog No.	Description	6+	3+	Each
21B09-480	Sample Valve (Stainless handle)	29.95	30.95	31.95
21B09-760	Replacement Seal Kit	2.75	2.85	3.00



PROPRIETARY SANITARY THREAD				
Catalog No.	Description	6+	3+	Each
21G09-103	Sample Valve (Black handle)	135.95	140.95	146.95
21G09-203	Sample Valve (Stainless handle)	143.95	149.95	155.95
21G09-104	Fiber Washer for Sanitary Thread	-	-	0.35



REPLACEMENT PARTS FOR PERLICK SAMPLING VALVES				
Catalog No.	Description	6+	3+	Each
21G09-106	Bonnet Assembly (Black handle)	58.95	60.95	63.95
21G09-108	Bonnet Assembly (Stainless handle)	66.95	69.95	72.95
21G09-107	Seat Cup (Silicone)	4.00	4.25	4.50
21G09-123	Seat Cup (EDPM)	4.00	4.25	4.50
21G09-120	Bonnet O-ring (Red)	-	-	0.85

Brewery Fittings



Sampling Valve Accessories

ATTACHES TO VALVE SPOUT BY PLACING LOOP OVER HOOK AND TIGHTENING THUMB SCREW



15-Turn Proof Coil AKA: Pig Tail

PIGTAIL HELPS PREVENT FOAMING WHEN SAMPLING



21G09-105
6+ **\$193.95**
3+ \$201.95
Ea. \$210.95

REPLACEMENT GASKET



21G09-122

50+ **44¢** 25+ 46¢
10+ 48¢ Ea. 51¢



5-Turn Proof Coil AKA: Pig Tail



21G09-102
6+ **\$188.95**
3+ \$196.95
Ea. \$204.95

1/4" FPT Attachments



Catalog No.	Description	6+	3+	Each
21G09-133	1/4" FPT (Points down)	169.95	176.95	183.95
21G09-132	1/4" FPT (Points up)	169.95	176.95	183.95

3/8" Barbed Attachments



Catalog No.	Description	6+	3+	Each
21G09-130	3/8" Barb (Points down)	136.95	141.95	147.95
21G09-131	3/8" Barb (Points up)	199.95	206.95	215.95

Capping Attachments



Catalog No.	Description	6+	3+	Each
21G09-134	Thumb screw	81.95	84.95	87.95
21G09-135	Keyed Lock-out	82.95	85.95	88.95

Brewery Fittings



Brewers Cleaning Brushes

MADE OF FDA APPROVED MATERIALS • HANDLES AND BRISTLES ARE TOUGH AND DURABLE

8" Short Handle Brush



FDA APPROVED MATERIALS

- Designed to work in the most comfortable positions and provide the most efficient cleaning
- Nylon bristles provide excellent chemical resistance
- Plastic handles are lightweight, break resistant, highly durable and "soak proof"
- Made of FDA approved materials

14P09-115
6+ **\$9.50**
3+ \$9.95 Ea. \$10.50

20" Long Handle Brush



FDA APPROVED MATERIALS



- Flare head design assures an efficient and all-around thorough cleaning and is comfortable to use
- Nylon bristles have excellent chemical resistance
- Plastic handles are lightweight, break resistant, highly durable and "soak proof"
- Made of FDA approved materials

14P09-116
6+ **\$12.50**
3+ \$12.95 Ea. \$13.95

Tank & Kettle Brush



Threaded block for use with handle

14U08-112
6+ **\$31.95**
3+ \$32.95 Ea. \$34.95

Fiberglass Sanitary Threaded Handle



5' length x 1" dia.

FOR USE WITH THE TANK & KETTLE BRUSH LISTED ABOVE

14U08-113 6+ **\$16.50** 3+ \$17.50 Ea. \$17.95

Additional price breaks available on most items. Login to your website account or contact your sales representative for pricing.

Black Nitrile Gloves

MEDIUM-DUTY • CHEMICAL RESISTANT



- 3 X more tear resistant than vinyl and latex gloves
- Powder and latex FREE
- Superior comfort and strength
- 100 universal gloves per box

20G06-144 MED / 20G06-145 LG / 20G06-146 X-LG
10+ **\$8.95** 5+ \$9.95 Ea. \$10.95

HD Orange Nitrile Gloves

HEAVY-DUTY • CHEMICAL RESISTANT • TEXTURED



- 2 X more tear resistant than medium duty black nitrile gloves
- Powder and latex FREE
- Superior comfort and strength
- Textured for improved grip
- 100 universal gloves per box

20G06-150 LARGE / 20G06-151 X-LARGE
10+ **\$13.50** 5+ \$13.95 Ea. \$14.95

Brewers Nitrile Gloves Elbow Length

HEAVY-DUTY • CHEMICAL RESISTANT

20G06-140 Size: Large
24+ **\$13.50** 12+ \$13.95
6+ \$14.95 Ea. \$15.95

100% neoprene glove with five piece flannel liner and special textured grip.

Very durable and launderable. Acceptable for food and beverage applications.

Five piece flannel liner helps keep hands cool and comfortable in all temperatures.



Brewer's Kettle Brushes and Gloves

A.E.B. Stainless Steel "Ball Lock" Product Tanks

FOR OVER 20 YEARS, A.E.B. HAS BEEN A WORLD LEADER IN THE PRODUCTION OF STAINLESS STEEL PRODUCT TANKS AND KEGS, SO IT'S NO WONDER THEIR NAME IS SYNONYMOUS WITH QUALITY AND DEPENDABILITY

Catalog No.	Description	48+	24+	8+	4+	Each
15C07-224	5 Gallon Rubber Top	83.95	86.95	90.95	93.95	97.95
15C07-124	5 Gallon Strap Handle	78.95	81.95	84.95	88.95	91.95
15C07-121	3 Gallon Strap Handle	76.95	79.95	82.95	85.95	89.95
15C07-119	2.5 Gallon Strap Handle	74.95	76.95	79.95	83.95	86.95



MADE IN ITALY

MORE OPTIONS AVAILABLE ON PAGES 11-12

- Manufactured of 304 grade stainless steel
- Sanitary robotic welded seams are uniform and provide a leak free seal that is free from any deposit of debris
- Each tank is passivated, washed and sanitized
- Each tank is etched with A.E.B. logo, mfg. date, Made in Italy, serial number, part number, NSF logo and is stamped with all compliant warnings



NFS Listed



ISO 9001:2008 certified

5 GAL RUBBER TOP 5 GAL STRAP HANDLE 3 GAL STRAP HANDLE 2.5 GAL STRAP HANDLE



ICE BLANKET

5 Gallon Product Tank Insulator AND ICE BLANKET FOR INCREASING COLD TIME

NEOPRENE INSULATING COVER WITH INSIDE POCKET FOR ICE BLANKET USED TOGETHER, WILL KEEP PRODUCT COLD FOR UP TO 24 HOURS



MADE IN USA

AMERICAN MADE

USING ONLY THE HIGHEST QUALITY MATERIALS AND WORKMANSHIP TO INSURE QUALITY AND DURABILITY

Catalog No.	Description	10+	5+	Each
15C07-160	Neoprene Insulation Jacket	26.95	27.95	28.95
15C07-170	Ice Blanket	14.95	15.50	15.95

Additional price breaks available on most items. Login to your website account or contact your sales representative for pricing.

CMBecker Plastic Disconnects

INTERNATIONAL, LLC

MADE IN GERMANY

ASSEMBLED IN AMERICA



BALL LOCK



BALL LOCK



PIN LOCK



PIN LOCK

More options available on pages 17-19

Ref.#	Catalog No.	Gas or Liquid	Connection Type	100+	50+	Each
1	07C07-115	Gas	1/4" MFL	2.60	2.65	2.80
1	07C07-116	Liquid	1/4" MFL	2.60	2.65	2.80
2	07C07-138	Gas	1/4" Barb	2.60	2.65	2.80
2	07C07-139	Liquid	1/4" Barb	2.60	2.65	2.80

Ref.#	Catalog No.	Gas or Liquid	Connection Type	100+	50+	Each
3	07C07-144	Gas	1/4" MFL	3.00	3.10	3.20
3	07C07-145	Liquid	1/4" MFL	3.00	3.10	3.20
4	07C07-142	Gas	1/4" Barb	3.00	3.10	3.20
4	07C07-143	Liquid	1/4" Barb	3.00	3.10	3.20

Product Tanks, Tank Insulator Jacket and Disconnects



Faucet Coupler & Adapter

ADAPTS A STANDARD FAUCET TO A 1/4" MFL DISCONNECT



Ref. #	Catalog No.	Description	25+	10+	Each
1	12B03-181	Faucet Coupler (Chrome)	1.93	2.05	2.15
Ref. #	Catalog No.	Description	50+	25+	Each
2	17C13-100	Faucet Adapter	1.95	2.05	2.50

Ball Lock Hand Pump



- 8" ABECO stainless pump with a thomas check valve
- 2' BEVLEX® tubing
- CM BECKER® gas disconnect

MADE WITH NAME BRAND QUALITY COMPONENTS

Catalog No.	Description	10+	5+	Each
18D03-210	Ball Lock Hand Pump	25.95	27.95	29.95

4' Disconnect Faucet



MADE WITH NAME BRAND QUALITY COMPONENTS

Ref. #	Catalog No.	Description	25+	10+	Each
1	17D03-102	4' Disconnect Faucet	3.75	3.95	4.25
Ref. #	Catalog No.	Description	100+	25+	Each
2	18A03-102	Barbed Faucet only	1.65	1.75	1.95

Sample Faucets



MADE WITH NAME BRAND QUALITY COMPONENTS

Catalog No.	Description	25+	10+	Each
17D03-106	Ball Lock	5.25	5.50	5.95
17D03-107	Pin Lock	5.51	5.99	6.50

Additional price breaks available on most items. Login to your website account or contact your sales representative for pricing.

"Pin Lock" Socket

SPECIALLY DESIGNED SOCKET IS NOTCHED TO FIT PIN-LOCK PLUGS • QUICK & EASY REMOVAL



Bleeder Valve

FOR USE WITH 1/4" MFL DISCONNECTS
Allows excess pressure to be bled off before disconnecting



17D03-103

6+ **\$12.95** 3+ \$13.95 Ea. \$14.95

Filtration Products for Beer

Reinforced, clear polypropylene housing allows home brewer to observe the filtration process. Housing is designed for the 10" length cartridges.



CAUTION: All filters and cartridges should be sanitized after use just like other beer making apparatus to prevent bacterial buildup.

Ref. #	Catalog No.	Description	24+	12+	6+	Each
1	09C02-101	Filter Housing (3/8" FPT-Ports)	16.95	17.95	18.95	19.95
2	09D03-104	Jumper Hose 3/8" MPT x 1/4" FFL	4.25	4.50	4.75	5.25
3	09I01-112	Cartridge, Pleated Sediment (1 Mic)	21.79	22.21	23.60	24.99
-	09C02-102	Replacement O-ring for 09C02-101	0.54	0.57	0.60	0.75
Ref. #	Catalog No.	Description	20+	10+	5+	Each
4	09S02-101	Cartridge, Spun Poly (Coarse)	5.22	5.37	5.68	6.04

Refrigerator Conversion Kits



Commercial Beers

KIT INCLUDES:

- 5 lb. CO₂ cylinder
- **American Sanke tap
- 1 or 2 gauge regulator
- Faucets/shank assembly
- Drip tray
- Necessary tubings
- Spanner wrench
- Faucet brush

**WARNING Import beers will require a different coupler

Catalog No.	Regulator	CO2 Filled/Empty	6+	3+	Each
*17D03-160	2 gauge	Filled	157.95	164.95	171.95
17D03-161	2 gauge	Empty	152.95	158.95	165.95
17D03-116	2 gauge	No cylinder	100.95	105.95	109.95
17D03-175	Add-a Faucet American Sanke kit		58.95	62.95	66.95

*HAZARDOUS MATERIALS FEE FOR SHIPPING



**OLD REFRIGERATOR
EQUALS
NEW KEGERATOR**



Home Brews

KIT INCLUDES:

- 5 lb. CO₂ cylinder
- **Ball-lock disconnects
- 2 gauge regulator
- Faucets/shank assembly
- Drip tray
- Necessary tubings
- Spanner wrench
- Faucet brush

**Specify if pin lock disconnects are needed

Catalog No.	Faucets	Regulator	CO2 Filled/Empty	6+	3+	Each
17D03-171	One	2 gauge	Empty	139.95	145.95	151.95
17D03-177	Two	2 gauge	Empty	172.95	180.95	187.95

Additional price breaks available on most items. Login to your website account or contact your sales representative for pricing.

**WITHOUT
PRODUCT TANK**

Home Brew Kegging Kits

FOR BALL-LOCK PRODUCT TANKS

**WITH
PRODUCT TANK**

KIT INCLUDES:

- CO₂ Cylinder 5 lb.
- Primary CO₂ Regulator
- Gas and Liquid Lines
- Ball-Lock Disconnects

Pin-Lock Kits Available
Call for Pricing



Catalog No.	CO2 - Filled/Empty	6+	3+	Each
17D03-167	Empty	103.95	109.95	113.95

Catalog No.	CO2 - Filled/Empty	6+	3+	Each
17D03-168	Empty	189.95	199.95	211.95



Hydrometers for Beer & Wine

CALIBRATED FOR READING AT THE BOTTOM MENISCUS AND STANDARDIZED AT 20° CELSIUS WITH TEMPERATURE CORRECTION SCALE.



BEST FOR PROFESSIONAL BREWERS



CONTAINS NO MERCURY • THERMOMETER RANGE 0° TO 50° CELCIUS FOR ALL HYDROMETERS • 14" LENGTH

THREE RANGES AVAILABLE



BEST FOR HOME BREWERS



TRIPLE SCALE 60°F • 10" LENGTH (NO THERMOMETER)

CONTAINS NO MERCURY • SPECIFIC GRAVITY • BALLING (BRIX) • POTENTIAL ALCOHOL BY VOLUME

Catalog No.	Balling Range (Plato)	10+	5+	Each
20C04-101	0 to 8-1/2	24.95	25.95	26.95
20C04-102	7-1/2 to 16	24.95	25.95	26.95

Catalog No.	Balling Range (Plato)	10+	5+	Each
20C04-103	15-1/2 to 24	24.95	25.95	26.95
20C04-104	Triple Scale (shown)	7.50	7.95	8.50

Additional price breaks available on most items. Login to your website account or contact your sales representative for pricing.

Counter Pressure Bottle Fillers and Tubing Kit

FILLS WITHOUT FOAMING!

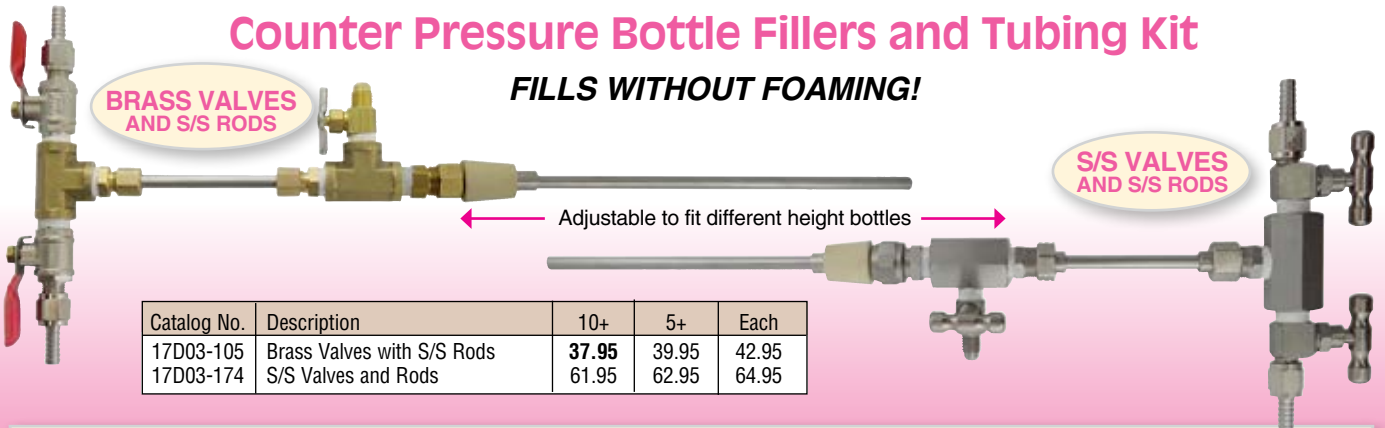

BRASS VALVES AND S/S RODS

S/S VALVES AND S/S RODS

← Adjustable to fit different height bottles →

Catalog No.	Description	10+	5+	Each
17D03-105	Brass Valves with S/S Rods	37.95	39.95	42.95
17D03-174	S/S Valves and Rods	61.95	62.95	64.95

Tubing Kit

CONNECTS BOTTLE FILLER TO PRODUCT TANK & CO₂ VALVE



Attaches to 1/4" MFL disconnects and 1/4" barbed shutoffs on bottle filler

17D03-101

10+ \$8.38 5+ \$8.76 Ea. \$9.33

Brewer's Heat Pad

PROVIDES IDEAL TEMPERATURE YEAR-ROUND

Supplies constant, steady convection heat without creating hot spots. Place on hard flat surface.

- 25W / 110V
- 11" square
- 6' length powercord

17D04-101

100+ \$9.95

50+ \$10.95 25+ \$11.95

10+ \$12.95 Ea. \$13.95



Hydrometers, Bottle Fillers, and Brew Heaters

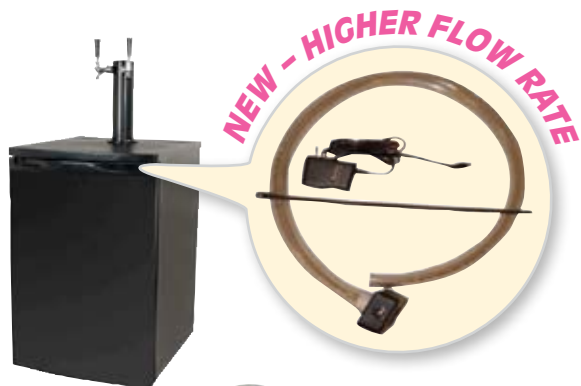

NEW - HIGHER FLOW RATE

Beer Tower Cooler Kit

HELPS ELIMINATE INITIAL USE WARM BEER / FOAM

ONCE INSTALLED, THE BEER TOWER COOLER WILL KEEP YOUR BEER SHANKS AND FAUCETS ICE COLD. ALSO HELPS REDUCE FAUCET MOLD AND BACTERIAL GROWTH.

INCLUDES: Blower & fan motor, 3/4" I.D. tubing, AC power supply, cable tie

17D02-105 12+ **\$23.95** 6+ \$24.95 3+ \$25.95 Ea. \$26.95

LIQUID



NEW DESIGN

NO ASSEMBLY REQUIRED

Keg Coupler Conversion Plugs

QUICKLY SWITCH FROM PRODUCT TANK TO KEG

ATTACH A PAIR OF BALL-LOCK DISCONNECTS TO YOUR EXISTING BEER LINES AND INSTALL THESE PLUGS ONTO YOUR KEG COUPLER. NOW YOU CAN EASILY SWITCH BETWEEN PRODUCT TANKS AND KEGS.

Catalog No.	Description	50+	25+	10+	Each
15G04-110	Gas Conversion Plug	9.50	9.95	10.50	10.95
15G04-111	Liquid Conversion Plug	9.50	9.95	10.50	10.95

CO₂ Corny Keg Charger

ATTACHES TO ALL 1/4" MFL DISCONNECTS

FINGER TRIGGER ALLOWS USER TO FINELY CONTROL THE RATE OF FLOW OF THE CO₂ GAS INTO THE PRODUCT TANK



BEST BUY
17L02-103
270 PC
CARTRIDGE
\$239.95

Catalog No.	Description	20+	10+	5+	Each
17L02-100	CO2 Corny Keg Charger	6.95	7.50	7.95	8.95
17L02-101	Refill Cartridge (6 pk)	7.95	8.50	8.95	9.50
Catalog No.	Description	8+	4+	2+	Each
17L02-102	Refill Cartridge (20 pk)	22.95	23.95	24.95	25.95



SLIGHT IMPERFECTIONS IN THE GLASS ARE NORMAL AND DO NOT AFFECT USE OR DURABILITY

RUBBER STOPPER INCLUDED

Borosilicate Glass Erlenmeyer Flasks

FOR SAFELY MIXING, HEATING AND MAKING YEAST STARTERS

HEAVY BEADED RIMS FOR INCREASED STRENGTH AND SAFETY
GRADUATION MARKS AND MARKING SPOT IN EASY-TO-READ WHITE

Catalog No.	Description	24+	12+	6+	Each
17D05-105	500 ml Flask	4.44	4.68	4.95	5.25
17D05-110	1000 ml Flask	7.19	7.58	7.95	8.50
17D05-120	2000 ml Flask	14.35	15.12	15.95	16.95

"The Adapter" CO-2-Go

ATTACHES A CO₂ REGULATOR TO A CO₂ PAINTBALL CYLINDER

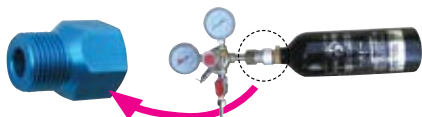

Catalog No.	Description	25+	10+	5+	Each
17A04-100	The Adapter	6.95	7.50	7.95	8.50

High Quality Stir Bars

CYLINDRICAL MAGNETS ENCAPSULATED IN PTFE FLUOROPLASTIC



Catalog No.	Length	Diameter	50+	25+	10+	Each
17D02-101	25 mm	7 mm	2.15	2.26	2.50	2.95
17D02-107	40 mm	8 mm	2.95	3.25	3.50	3.95
17D02-108	50 mm	8 mm	4.95	5.25	5.50	5.95



Five-Star® Home Brewing Chemicals

P.B.W. Brewery Wash



Buffered alkaline cleaner that replaces caustic soda cleaners.



Catalog No.	Size	3+	2+	Each	
20G06-149	P.B.W. 120gm / 25 bottles	66.95	68.95	71.95	
Catalog No.	Size	24+	12+	6+	Each
20G06-110	P.B.W. 1 lb.	6.50	6.75	7.25	7.75

5² pH Stabilizer



Optimizes the enzymatic activity of your malt and helps clarify wort.



Catalog No.	Size	12+	6+	Each
20G06-118	5 ² pH Stabilizer 4 oz.	5.50	5.95	6.50
Catalog No.	Size	12+	6+	Each
20G06-119	5 ² pH Stabilizer 1 lb.	9.95	10.50	10.95

Star San Acid Sanitizer



A synergistic acid blend provides a unique killing system that is unaffected by excessive organic soils.



Catalog No.	Size	100+	50+	25+	Each
20G06-126	Star San 4 oz.	4.25	4.50	4.75	4.95
Catalog No.	Size	24+	12+	6+	Each
20G06-127	Star San 8 oz.	6.95	7.50	7.95	8.50
20G06-128	Star San 16 oz.	10.95	11.50	11.95	12.50

IO-Star Iodophor



For sanitizing beverage containers and equipment. Effective against ecoli, mold and yeast.



Catalog No.	Size	100+	50+	25+	Each
20G06-123	IO-Star 4 oz.	2.20	2.30	2.40	2.50
Catalog No.	Size	20+	10+	5+	Each
20G06-124	IO-Star 32 oz.	11.50	11.95	12.95	13.50

Home Dispensing Conversion Kit

DESIGNED TO HELP ELIMINATE BACTERIA BETWEEN CLEANINGS

Kit includes everything you need to convert your PVC tubing system to a PVC-FREE and antimicrobially clean system.

KIT INCLUDES: 7' Ultra Barrier Silver (product line) and 5' Ultra Barrier (gas line)

DISCONTINUED \$13.95



08F01-120

Additional price breaks available on most items. Login to your website account or contact your sales representative for pricing.

Cleaning Kit

FOR HOME BREWERS

QUICK AND EASY TO USE

KIT INCLUDES:

- Pump/bottle assembly,
- Superflush Cleaner 1 qt.,
- Faucet brush,
- Faucet wrench



Catalog No.	Description	12+	Each
20D03-189	Cleaning Kit (complete)	41.95	44.95
20G09-209	Superflush, 1 quart (only)	3.50	3.95
20A03-140	Pump/Bottle assy. (only)	31.95	33.95

Counter Pressure Keg Filler

DESIGNED FOR USE WITH AMERICAN SANKE KEGS

NEW DESIGN

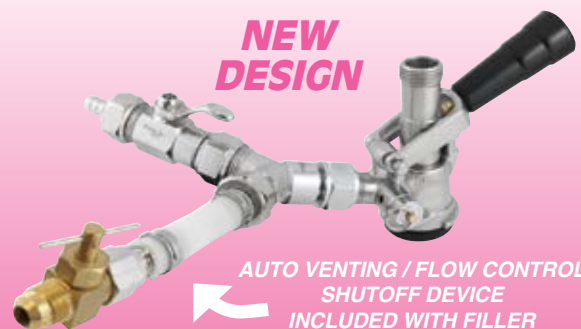

AUTO VENTING / FLOW CONTROL SHUTOFF DEVICE INCLUDED WITH FILLER PURCHASE OR SOLD SEPARATELY

Catalog No.	Description	6+	3+	Each
17D03-108	C.P. Keg Filler (complete)	58.95	60.95	63.95
07D03-104	Auto Vent Device only	16.95	17.95	18.95

- A**
- ABC Permanent O-Ring 8, 67, 2221
 - Access Valves (Refrigeration) 108
 - Adapt-A-Valve (3 Way) 74, 89
 - Adapter (56C Frame Motor) 51
 - Adapter (CO-2-Go) 252
 - Adapter (Faucet Cleaning) 119
 - Adapter (Faucet to Disconnect) 249
 - Adapter (Regulator to Paintball Cyl) 252
 - Adapter Ring (Cylinder Carry Handle) 6
 - Adapters (for Product Tank Plugs) 16
 - Adjustable Tubing Clamps 82, 205
 - Adjustable Wrenches 116
 - Agitator Pumps & Motors 45, 105
 - Air Blowers & Brackets 155
 - Air Compressors 26, 154
 - Air Distributor Fittings (Beer & Soda) 67, 221
 - Air Distributors (Beer) 219-220
 - Air Distributors (Soda) 65-66
 - Alarm, CO₂ 5
 - Allen Wrenches 116
 - Alligator Pliers 115
 - Appliance Hand Trucks 110-111
 - Automatic CO₂ Changeover Valves 217
- B**
- Back Bar Coolers 148
 - Backflow Preventers 17, 54
 - Bag-N-Box Beverage System Cleaner 28, 128
 - Bag-N-Box Connectors/Adapters 27
 - Bag-N-Box Pumps 22-25
 - Bag-N-Box Racks 21
 - Bag-N-Box System Cleaner 28, 128
 - Bag-N-Box Tubing 27
 - Ball Valves (All Types) 85, 134
 - Barguns & Accessories (Wunderbar) 30-33, 57
 - Beer Engines 234
 - Beer Kegs (1/6 Barrel) 231
 - Beer Pumps (Flojet & Shurflo) 153
 - Beer Switch 198
 - Bevclean (B-I-B Beverage Cleaner) 28, 128
 - Beverage-Air Dispensers 148
 - Bleeder Valve 249
 - Blenders, Gas (Nitrogen/CO₂) 154
 - Blowers & Brackets 155
 - Blowout Kit 4, 107, 218
 - Bonnet Anglers 187
 - Bottle Fillers (Homebrew) 251
 - Bottled Water Dispensing 72
 - Boxes (Parts, Satchel Style, Tool) 118
 - Brackets, Cylinder 7
 - Brackets, Mounting (Syrup Pump) 22, 24, 26
 - Brackets, Wall (Beer) 199
 - Brass Fittings (All Types) 85-90
 - Breather (Cask) 235
 - Breathers (Tri-Clover Compatible) 239
 - Brewers Chemicals 122-128
 - Brewers Gloves 130, 247
 - Brewers Heat Pad 251
 - Brewers Kettle Brushes 247
 - Brewers Thermo-Hydrometers 251
 - Brewers Tri-Clover Comp. Fittings 236-246
 - Brix Cups 41
 - Brix Pumps (Shurflo) 23
 - Bronco Pump (Keg Pump) 222
 - Brushes (Direct Draw) 130
 - Brushes (Faucet) 130
 - Brushes (Glass Washer) 118
 - Brushes (Kettle/Tank) 247
 - Bundle Tubing Cutter 80
 - Bundle Tubing (Soda) 80
- C**
- Cable Ties (Self-Locking) 84, 155
 - Capacitor (Compressor) 107
 - Caps (Beer Faucet) 188
 - Carbonation Lid 12, 46
 - Carbonation Stones 46
 - Carbonation Tester (Beer) 121
 - Carbonation Testers (Soda) 29
 - Carbonator (Recirculating) 47
 - Carbonator Motors 50, 150
 - Carbonator Replacement Parts 48-49
 - Carbonator Shelving 50
 - Carbonator/Nitro Tanks (Motorless) 46, 135
 - Carbonators 48-49
 - Carry Handles (CO₂ Cylinders) 5
 - Carry Handles (Steel Cylinders) 6
 - Cartridges (Filter System) 68-72
 - Cartridges (Gas-CO₂, Argon, Nitrogen) 224
 - Cask Equipment 234-235
 - Caution Labels (CO₂ & Blended Gas) 8
 - Ceramic Tap Handles 186
 - Ceramic Towers 141, 168-169
 - Changeover Valves, Auto (CO₂/N₂) 3, 217
 - Changeover Valves, Low Pressure 4, 218
 - Changeover Valves, Manual (CO₂) 4, 218
 - Charging Manifold 107
 - Charging Scale (Digital) 107
 - Check Valve (Cask) 235
 - Check Valves (S/S Fittings) 17, 54
 - Check Valves (Tri-Clover Compatible) 237
 - Chemicals (Brewers) 121-129
 - Chemicals (General Cleaning) 129
 - Chemicals (Home Brew) 253
 - Chemicals (Line Cleaning) 122, 124, 126-128
 - Chiller (Motors) 146,
 - Chillers, Flash 47, 149
 - Chillers, Glycol 143-145, 147
 - Chlorine Test Papers 130
 - Circuit Tester 109
 - Citrus Cleaner 129
 - Clamp Kits 82, 205
 - Clamp Pincers & Cutter 83, 207
 - Clamp-On Tower Drain 160
 - Clamps (Procon Pump) 51
 - Clamps (Tri-Clover Compatible) 240
 - Clamps, Tubing (Adjustable) 82, 205
 - Clamps, Tubing (All Types) 81-82, 205
 - Cleaner, Coil 107
 - Cleaner, Contact 129
 - Cleaner, Ice Machine 107
 - Cleaning Adapters 119-120
 - Cleaning Cans 120
 - Cleaning Caps 119
 - Cleaning Cards (Vending) 109
 - Cleaning Chemicals (Brewery) 122-128
 - Cleaning Chemicals, Line (Beer) 122-128
 - Cleaning Chemicals, Line (Soda) 28, 128
 - Cleaning Equipment 119-120
 - Cleaning Kit (Home Brew) 253
 - CO₂ Adapter (Reg to Paintball Cyl) 252
 - CO₂ Alarms 5
 - CO₂ Breather (Casks) 235
 - CO₂ Cornykeg Charger 252
 - CO₂ Changeover Valves (Manual) 4, 218
 - CO₂ Cylinder Accessories 8
 - CO₂ Cylinder Brackets 7
 - CO₂ Cylinder Storage Rack 3
 - CO₂ Cylinders 2
 - CO₂ Fill Connector 8
 - CO₂ Fittings 6, 67, 211
 - CO₂ In-Line Leak Indicators 153
 - CO₂ Picnic Pump 224
 - CO₂ Purification Filter 7
 - CO₂ Quick Coupler 67, 221
 - CO₂ Regulators (Beer) 208-211
 - CO₂ Regulators (Soda) 60-64
 - CO₂ Tags (Full/In Use/Empty) 8
 - CO₂ Tank Labels 8
 - CO₂ Valve Connectors/Washers 67, 221
 - CO₂ Valves 9
 - CO₂ Washers 6, 8, 221
 - CO₂ Wrenches 6
 - Cobra Pliers 115
 - Cocktail Direct Draw Dispensers 142
 - Coffee Dispensing Equipment 131-135
 - Coffee Pot Cleaners 125-126
 - Coil Dispensers (Beer) 227-228
 - Coil/Fin/Evaporator/Cond Cleaner 107
 - Coils (Stainless Steel) 229
 - Cold Controls 106
 - Cold Plate (Flash Chilling) 149
 - Cold Plate Dispensers (Beer) 227-228
 - Cold Plates, Fittings & Wire Rack 56, 229
 - Colder Products (Quick Couplings) 102-103
 - Column Expansion Kits 159
 - Column Shanks, Parts & Accessories 159-160
 - Column Standards (Beer) 156-158
 - Column Standards (Coffee) 131-132
 - Column Standards (Wine) 131-132
 - Combination Lock 109
 - Compressors (Embraco & Aspera) 104
 - Compressors, Air 26, 154
 - Condensate Drain 107
 - Condensate Pump 107
 - Condenser Fan Motors 105, 150
 - Concession Equipment Cleaner 129
 - Contact Cleaner 129
 - Conversion Kit (ABC O-Ring) 8
 - Conversion Kit (Cylinder) 6
 - Conversion Kits (Home Brew) 250
 - Conversion Kits (Refrigerator) 250
 - Conversion Plugs (Keg Coupler/Disc) 252
 - Conversion Plugs (Product Tank) 16
 - Cooling Blocks 175
 - Cooling Kit (Beer Tower) 252
 - Copper Tubing 75, 108
 - Cords, Service (Line Only or Male Plug) 50, 150
 - Cornykeg Charger (CO₂) 252
 - Cornykeg Insulation Jacket 20, 248
 - Cornykegs (Product Tanks) 11-12, 248
 - Counter Pressure Bottle Fillers 251
 - Counter Pressure Sanke Keg Filler 253
 - Couplers, Keg (American Sanke) 190-191
 - Couplers, Keg (European & Import) 191-193
 - Couplers, Keg (Fits: Keykeys) 192-193
 - Couplers, Keg (Repair Parts) 194-197
 - Couplers, Keg (Pressure/Temp Test) 121
 - Couplers, Keg (Wine) 191
 - Coupling Rings (for Shanks) 177
 - Couplings, Wall 230
 - Creamer Faucets 181
 - Cuno Water Filtration 70
 - Curb Ramps 113
 - Cutters, Tubing & Hose 83, 206
 - Cylinder Brackets 7
 - Cylinder Cap 5
 - Cylinder Handles 5-6
 - Cylinder Hanger (5 Lb) 226
 - Cylinder Labels 8
 - Cylinder Locks (Vending Machine) 109
 - Cylinder Storage Racks, 20 Lb 3
 - Cylinder Tank Boot 6
 - Cylinder Tank Connector Hoses 4
 - Cylinder Trucks 112
 - Cylinder Valves (CO₂/N₂) 9
 - Cylinder Valves Replacement Parts 10
 - Cylinders, CO₂ and Nitrogen 2
- D**
- Deep Well Coolers 148
 - Degreasers 129
 - Depressurizer (Pin-Lock) 16
 - Diagonal Cutters (Wire) 116
 - Dial & Digital Thermometers 29, 108
 - Direct Draw Dispensers 148-149
 - Disconnect Replacement Parts 19
 - Disconnects (Pin-Lock & Ball-Lock) 17-19, 248
 - Dispensers, Coil & Cold Plate (Beer) 148, 227-228
 - Dispensers, Post-Mix (Ice/Drink) 42-43
 - Dispensers, Post-Mix (Parts) 43
 - Dispensing Valves (Post-Mix) 31-40
 - Dispensing Valves (Pre-Mix) 57-58
 - Disposable Gloves (Nitrile) 130, 247
 - Dollies, Hand Truck (All Types) 110-113
 - Dollies (for 1/6, 1/4 & 1/2 Barrel Kegs) 232-233
 - Domes (Columns) 160
 - Draftec Line Cleaners 126
 - Drain Tubes (Threaded) 169
 - Drain Tubing 79, 203
 - Drain (Clamp-On-Tower) 160
 - Drain, Condensate 107
 - Drain (Jockey Box) 226
 - Drains (All Types) 140, 169-175, 226
 - Drill Bits (Cobalt) 117
 - Drip Trays 171, 174-175
 - Dryers, Filter 108
 - Dual Hand Trucks 111
 - Duplex Couplings (Beer) 198

- E**
- Electrical Accessories 49
 - Electrical Tape 49
 - Eliminator (Auto Changeover Valve) 3, 217
 - Erlenmeyer Flasks 252
 - Everpure Water Filtration 68-69
 - Expansion Kits (Columns) 159
- F**
- Fan Blades 107
 - Fan Motors 107
 - Fasteners (Secur-A-Tie) 20
 - Fasteners (T-Clip) 84
 - Faucet Adapter (Barbed Fitting) 119
 - Faucet Adapter (Faucet to Disconnect) 249
 - Faucet Brushes 130
 - Faucet Caps & Plugs 188
 - Faucet Handles & Knobs 186-187
 - Faucet Locks 188
 - Faucet Plug 186, 188
 - Faucet Wrenches 121
 - Faucet, Beer (Replacement Parts) 183-185
 - Faucets (Barbed Plastic-Self Closing) 249
 - Faucets (Beer-All Types) 178-182
 - Faucets (Brewers-Sampling) 245
 - Faucets (Cornykeg Sample) 249
 - Faucets (4' Disconnect) 1/4 MFL 249
 - Faucets (Water, Tea, Coffee) 75, 178-182
 - Faucets (Wine) 133
 - Filter Cartridges (All Types) 68-72, 249
 - Filter Dryers 108
 - Filter Housings 69, 249
 - Filter System (CO₂) 7
 - Filters (Home Brew) 249
 - Filters (In-Line) 72
 - Filtration Systems (Home Brew) 249
 - Filtration Systems (Water) 68-72
 - Fin Comb Set 107
 - Fittings, Beer Thread 198-199
 - Fittings, Brass (All Types) 85-90
 - Fittings, CO₂ 67, 221
 - Fittings, Compression 75, 89
 - Fittings, Lead-Free Brass 90
 - Fittings, Nitrogen 67, 221
 - Fittings, Plastic (All Types) 98-103
 - Fittings, Push-In Tube 98-100
 - Fittings, Quick Couplings 102-103
 - Fittings, Shut-Off Valves (All Types) 85
 - Fittings, Stainless Steel (All Types) 91-97
 - Fittings, Swivel Nut/Stem Set 91
 - Fittings, Syrup Pump 23, 25
 - Fittings, Tri-Clover Compatible 236-246
 - Fittings, Wine (304 S/S) 134, 200
 - Five Star Chemicals 122-123, 253
 - Flanges (Tri-Clover Compatible) 243
 - Flanges, Shank 177
 - Flare Washers 91
 - Flaring Tools 116
 - Flash Chillers 47, 149
 - Flasks, Erlenmeyer 252
 - Flavor Rescue Kit 128
 - Flow Control Faucets 182
 - Flow Control, In-Line (Beer) 153
 - Flow Restrictors (for Shanks) 176-177
 - Flow Reversal Valve (Flojet) 153
 - Flushers (Cleaning) 119
 - Flypunch!, Aunt Fannie's 189
 - Foam Preventers 152
 - Foam Tube and Sheet Insulation 84, 155, 201
 - Fob Panels 214-215
 - Folding Hand Truck 113
 - Fruit Fly Bar Pro Strips 28, 189
- G**
- Gas Blenders 154
 - Gas Tubing (Outdoor) 79
 - Gaskets (Tri-Clover Compatible) 243-244
 - Gauge Boot (Rubber) 59
 - Gauge Protectors 59, 63, 212
 - Gauges (Dry and Liquid Filled) 59
 - Glass Fillers 75
 - Glass Rinsers & Glass Rinser Drains 170-175
 - Glass Washers 118
 - Gloves (Nitrile) 130, 247
- Glycol Chillers** 143-147
- Glycol Trunklines** 151
- Glycol, Propylene** 150
- Grommets and Ferrules (for Coils)** 229
- Growler Filling Stations** 158
- Growler Filling Tubes** 188
- H**
- Hand Pulls (Beer Engines) 234
 - Hand Tools (All Types) 114-117
 - Hand Truck Wheels 110-111, 113
 - Hand Trucks (All Types) 110-113
 - Handle Extensions (Faucet) 187
 - Handle Inserts 186
 - Handles, Beer Faucet (All Types) 186-187
 - Heat Gun (Professional) 109, 117
 - Heat Pad (Brewers) 251
 - High Alkaline Line Cleaner 127
 - High Pressure Hose, CO₂ 4, 218
 - High Temperature Tubings 79, 244
 - Hole Saws and Arbors 117
 - Home Brew Products 248-253
 - Hop Filter (Cask Taps) 235
 - Hose & Tubing Cutters 80, 83, 206
 - Hydrometers 251
- I**
- Ice Bank Controls 106
 - Ice Blanket (Product Tank) 20, 248
 - Ice Chests (with Sealed-In Cold Plate) 55
 - Ice Machine Cleaner 107
 - Ice/Drink Post-Mix Dispensers 42-43
 - Iceless Pour Thermal Insulation Jacket 230
 - Infrared Thermometers 29, 108
 - Insecticide, Industrial 28, 129, 189
 - Inserts, Faucet Handle 186
 - Insta-Balance (Flow Restrictors) 176-177
 - Insulation Jacket (Kegs) 230-231
 - Insulation Jacket (Product Tanks) 20, 248
 - Insulation, Foam Tube and Sheet 84, 155, 201
 - Insulation, Procon Pump 51
 - Iodine Test Papers 130
 - ITW Dispense Regulators 208
- J**
- Jockey Boxes (Beer) 227-228
 - John Guest Fittings 100
 - Juice Pump (Flojet & Shurflo) 22-25
 - Juice Valve (Flomatic) 38
 - Jumper (Faucet Cleaning) 119
 - Jumpers (Beer Dispensers) 228, 230
 - Jumpers (Product Tank) 12
- K**
- Keg Bumper 231
 - Keg Charger (CO₂) 252
 - Keg Coupler Conversion Plugs 252
 - Keg Couplers (All Types) 190-193
 - Keg Couplers (Replacement Parts) 194-197
 - Keg Couplers (Wine) 135, 191
 - Keg Dollies (1/6, 1/4 & 1/2 Barrel) 232-233
 - Keg Filler (Counter Pressure) 253
 - Keg Filling/Washing Head 121
 - Keg Hand Truck 111
 - Keg Jacket (1/2 Barrel) 231
 - Keg Jacket (Iceless Pour 1/6 & 1/2 Barrel) 230
 - Keg Pressure Tester 121
 - Keg Racks (Multiple Sizes Available) 231
 - Keg Spacers and Stackers 232-233
 - Keg Tap Pressure Tester 121
 - Kegerators 148
 - Kegging Kits (Home Brew) 250
 - Kegs-American Sanke (1/6 Barrel) 231
 - Kettle Brushes 247
 - Keystones (Cask) 235
 - Kleen Plug 188
 - Knobs, Faucet 186-187
 - K-Way Replacement Parts 45
- L**
- Labels (CO₂ Tank) 8
 - Labels, Pre-Mix Dispensing Valve 58
 - Leak Detector Liquid 107, 129
 - Leak Indicators (In-Line) 153
 - Leatherman Hand Tools 114
 - Line Cleaning Chemicals 122-128
 - Line Cleaning Equipment 119-120
- Line Cleaning Valves (Flojet & Shurflo)** 23, 153
- Line Cord, (3 Wire 16 & 14 Gauge)** 49
- Liquid Level Control Board** 45
- Locking Flange** 176
- Locks, Combination (Masterlock)** 109
- Locks, Faucet (Beer)** 188
- Locks, Padlocks (Masterlock)** 109
- Locks, Sampling Valves (Brewers)** 246
- Locks, Vending (Cylinder)** 109
- Lubricants, Sanitary Food Grade** 125, 225
- M**
- Mag Drive Pump/Motor Assembly 51
 - Manifold, Test/Charge (Refrigeration) 107
 - Manifolds (Beer) 199
 - Manifolds (Line Cleaning) 56, 119
 - Manifolds (Sanitizing) 56
 - Manual CO₂ & N₂ Changeover Valves 4, 218
 - Mccann's Carbonators 48
 - Mcdantim Blenders 154
 - Motorless Carbonation Tanks 46, 135
 - Motors (Agitator) 45, 105, 150
 - Motors (Carbonators & Chillers) 50, 150
 - Motors (Condenser Fan) 105, 150
 - Motors (Fan) 105
 - Mounting Brackets (Syrup Pump) 26
 - Mounting Hardware Kits (Columns) 160
 - Multiplex Soda Factory 47
 - Multi-Tester (Voltage) 109
 - Multi-Tools (Leatherman) 114
- N**
- National Chemicals Line Cleaners 124-125
 - Needle Valves (All Types) 85
 - Nitrile Gloves (Black or Orange) 130, 247
 - Nitrogen Changeover Valves (Manual) 4, 218
 - Nitrogen Cylinders 2
 - Nitrogen Fittings 67, 221
 - Nitrogen Regulators (Beer) 210-211
 - Nitrogen Regulators (Coffee) 135
 - Nitrogen Regulators (Soda) 62-63
 - Nitrogen Regulators (Wine) 135
 - Nitrogenating Tanks (Motorless) 46, 135
 - Nitrogen Valves 9
 - Nuts (Beer Thread) 198
- O**
- Oetiker Clamps 81-82
 - Old Fashion Soda/Water Fountains 44
 - One Trip Only Caps (Product Tank) 20
 - O-Ring Tool Kit 117
 - Overflow Bottle (Foam Preventer) 152
- P**
- Padlocks 109
 - Pallet Jack 113
 - Panels (Beer Pump) 216
 - Panels (Secondary Regulator) 213-215
 - Parts Boxes 118
 - Perlick Quick Chill Section 136-146
 - Permanent O-Ring Conversion Kit 8
 - Pest Control Strips 28, 189
 - Petro-Gel Lubricant 125
 - Ph Testers, Digital Pocket & Strips 130
 - Picnic Pumps (All Types) 222-225
 - Picnic Pumps Replacement Parts 222, 224-225
 - Pigtails (5 & 15-Turn Proof Coils) 246
 - Pilferage Protectors (Cyl. Valves) 8
 - Pincers, Clamp 83, 207
 - Pinch-Off Tool 83, 117, 207
 - Pin-Lock Socket 16, 249
 - Pliers (All Types) 114-116
 - Pliers (Snap Ring) 6, 115
 - Plug Adapters (Pin-Lock & Ball-Lock) 16
 - Plugs, Electrical 49
 - Polish Compound (Brass/Chrome) 129
 - Pony Pump (Keg Pump) 222
 - Portable Dispensers (Beer) 227-228
 - Post-Mix Soda Dispensers (All Types) 31, 42-43
 - Post-Mix Valves 34-40
 - Power Cords 50, 150
 - Pre-Chillers 47
 - Pre-Mix Dispensing Valves 57-58
 - Pressure Tester (for Kegs) 121
 - Probe, Carbonator 48-49
 - Procon Pump Accessories 51

- Procon Pumps 51-53
Product Tank Adapter/Conversion Plugs 16
Product Tank Insulation Jacket 20, 248
Product Tank Replacement Parts 12-15
Product Tanks (Corny Kegs) 11-12, 248
Proof Coils (5 & 15 Turn) 246
Propylene Glycol 100% 150
Pump And Motor Assembly (Chillers) 146, 150
Pump Panels (Beer Pump-All Types) 216
Pump, Bottled Water 72
Pump, Condensate 107
Pumps (Agitator) 45, 105
Pumps, Beer (Flojet & Shurflo) 153
Pumps, Brix (Shurflo) 23
Pumps, Glycol (Additional) 146, 150
Pumps, Hand (Home Brew) 249
Pumps, Juice (Flojet and Shurflo) 22-24
Pumps, Line Cleaning 119
Pumps, Picnic (All Types) 222-224
Pumps, Procon 51-53
Pumps, Submersible 45, 105
Pumps, Syrup (Flojet & Shurflo) 22-25
Pumps, Water Booster 73
Purdy Products (Chemicals) 126
Push-In-Tube Fittings 98-100
- Q**
Quick Chill Products by Perlick 136-146
Quick Coupler for CO₂ 67, 221
Quick Fill CO₂ Connector 8
Quick Couplings (Colder Products) 102-103
- R**
Racks (Bag-N-Box) 21
Racks (up to 1/2 Barrel Keg) 231
Ramp, Curb (for Hand Trucks) 113
Recirculating Carbonators 47
Recirculating Glycol Trunklines 151
Recirculating Line Cleaning Pumps 119
Reducers (Tri-Clover Compatible) 240
Refractometers 28, 154
Refrigerator Conversion Kits 250
Regulator Parts & Access. (Beer) 212
Regulator Parts & Access. (Soda) 59, 63
Regulators (Beer) 208-212, 216
Regulators (Coffee) 135
Regulators (Panel Assemblies) 213-216
Regulators (Soda) 60-64
Regulators (Water Pressure) 74
Regulators (Wine) 135
Regulators (Nitrogen) 210-211
Relief Valves (Multi Purpose) 54
Relay (Starter/Relay) 107
Rinsers (Glasses, Pitchers, etc.) 173-175
Rotary Vane Fluid Pumps 51-53
- S**
Saddle Valves (Lead Free) 74, 89
Sample Valves (Brewers) 245
Sampling Faucets (Home Brewers) 249
Sanitary Caps (Product Tank) 20
Sanitizers and Detergents 122-128
Sanitizing Manifolds 56
Sanitizing Valves (Flojet) 23
Satchel Compartment Boxes 118
Scale, Charging (Digital) 107
Scouring Pads 129
Screwdrivers 116-117
Sealant, Silicone 100% 129
Secur-A-Tie Tamper Evident Fasteners 20
Selecto Water Filtration 71
Self-Closing Faucets 181-182
Service Cords (Line Only or Male Plug) 49-50
Shank Replacement Components 160, 177
Shanks (Chrome Plated) 176-177
Shanks (Column) 159
Shanks (Dual) 177
Shanks (Stainless Steel) 134
Shanks (Tower) 134
Shanks (Wine) 133-134
Shanks (Thread-In) 176
Shelving (Carbonator) 50
Shives (Cask) 235
Shut-Offs (All Types) 85, 134, 198
- Sight Glasses (Tri-Clover Compatible) 237
Silicone Lubricants 125
Silicone Sealant 129
Silicone Tubing (Hi Temperature) 244
Snap Ring Pliers 6, 115
Snap Rings (CO₂ Cylinders) 5
Soaps, Low Foam (for Glass Washers) 79, 244
Socket (Pin-Lock) 16, 249
Soda Cleaning Chemicals 28, 128
Soda Dispensers (All Brands) 42-44
Soda Factory 47
Soda Fountain Faucets 44
Soda Tubing (All Types) 76-80
Soda Valves 31, 34, 36, 38, 40
Solvent (Lime & Mineral) 125
Spacers (for Kegs) 232-233
Spacers, Shank 160, 177
Special Event Items 222-223
Spiles (Cask) 235
Spirit Thermometers 29, 108
Splicers, Barbed (Beer) 200
Squeeze Valves (Pre-Mix) 57
Stackers (for Kegs) 232-233
Stainless Steel Cleaner 129
Stainless Steel Fittings (All Types) 91-97
Stands, Drop-In Conversion 43
Starter (Relay) 107
Stir Bars 252
Stop Valves (Water Supply Line) 98-100
Storage Boxes and Cabinet 118
Stout Faucets 180
Strainers 54
Submersible Pumps & Motor 45, 105
Superflush Line Cleaner 127
Syrup Pump Mounting Brackets 22, 24
Syrup Pumps (Flojet & Shurflo) 22-25
Syrup Racks (Bag-N-Box) 21
Syrup Separators 41
Syrup Tanks (Corny Kegs) 11-12, 248
- T**
T-Clip Fasteners 84
Tail Pieces (Beer) 200
Tamper Evident Caps (Product Tank) 20
Tamper Evident Ties (Product Tank) 20
Tank Boot 6
Tank Brushes/Handles 247
Tap Handle Inserts 186
Tap Handles 186-187
Tape, Aluminum 84, 201
Tape, Cold Temperature 84, 201
Tape, Duct 84, 201
Tape, Electrical 49
Tape, Foam Insulation 84, 201
Tape, Teflon 129
Tape, Vinyl 84, 201
Tapping Kits (Beer Dispensers) 226
Taps, Cask (All Types) 234
Taps, Keg (All Styles) 135, 190-193
Taps, Keg (Repair Parts) 194-197
Taps, Keg (Wine) 135, 191
Test Coupler (Pressure/Temp) 121
Test Papers (Sanitizing Solutions) 130
Thermometers (All Types) 29, 108
Thermostats 106
Thermowells (Tri-Clover Compatible) 242
Thread Protectors (Cyl. Valves) 8
Thread Sealant Tape & Liquid 129
Tm Desanamax Line Cleaner 127
Tool Box 118
Tools, Flaring 116
Tools, General Hand 114-117
Tools, Leatherman 114
Tower Cooling Kit 252
Tower Expansion Kits 159
Towers, Beer (All Types) 136-141, 161-169
Towers (Ceramic) 141, 168-169
Towers (Coffee) 131-132
Towers (Wine) 131-132
Transfer Valves (Flojet & Shurflo) 23, 25
Transformer 45
Tri Clover Compatible Fittings 236-245
Trunklines (Beer) 151
- Tubing (Air Duct) 155
Tubing (Bag-N-Box) 27
Tubing (Beer) 202-204
Tubing (Copper) 75, 108
Tubing (Drain) 79, 203
Tubing (EJ Beverage) 204
Tubing (Foam Insulation) 84, 155, 201
Tubing (High Temperature) 79, 244
Tubing (Homebrew Conv Kit) 253
Tubing (Outdoor Gas Line) 79
Tubing (Silicone Hi Temp) 79, 244
Tubing (Soda Bundles) 80
Tubing (Soda) 76-80
Tubing (Ultra Barrier) 204
Tubing (Wine) 135
Tubing Bender (3/8 Copper Tube) 116
Tubing Clamps (All Types) 81-82, 205
Tubing Cutters 80, 83, 116, 206
Tubing Fasteners 84, 155
Tubs, Gorilla/Tubtrugs (Flexible Tubs) 226
- U**
Under Bar Dispensers (Beer) 164-165
- V**
Vacuum Regulator (Shurflo) 23
Valve, Bleeder 249
Valves, Access (Refrigeration) 108
Valves, Adapt-A-Valve 74
Valves, Ball (All Types) 85
Valves, CO₂ and Nitrogen 9
Valves, Check 54
Valves, Cleaning Can 120
Valves, CO₂ Changeover 3-4, 217-218
Valves, Dispensing (Pre-Mix) 57-58
Valves, Flow Check 17
Valves, Flow Reversal 153
Valves, Needle 85
Valves, Post-Mix (All Brands) 34-40
Valves, Pre-Mix 57-58
Valves, Relief 54
Valves, Saddle (Lead Free) 74, 89
Valves, Sampling (Brewers) 245
Valves, Sanitizing (Flojet & Shurflo) 23
Valves, Shut-Off 198
Valves, Transfer (Flojet & Shurflo) 23, 25
Valves, Tri-Clover Compatible 236-237
Vending Machine Dillies 110-111
Vending Machine Locks 109
Vending Machine Cleaning Cards 109
Vent Device (for Keg Fillers) 253
Vinyl Ducting 155
Voltage Tester, Multi Pocket 109
- W**
Wall Brackets (Beer) 199
Wall Couplings (for Beer Dispensers) 230
Washer, Beer (Kit) 205
Washers (CO₂) 67, 221
Washers (Flare) 91
Washers (Wall Coupling) 230
Water Booster Pumps (All Types) 73
Water Booster Systems (All Types) 73
Water Fountain Faucets 44
Water Filtration Systems 68-72
Water Pressure Regulators (All Types) 74
Watts Backflow Preventers 54
Wheels, Replacement (Hand Truck) 110-111, 113
Winch Lift Unit 113
Wine Dispensing Products 131-135
Wire Connectors (Caps, Eylets, Spades) 49
Wire Cutters and Strippers 116
Wire Rack (Cold Plates) 56, 229
Wire, Bulk (3-Wire, 16 & 14 Gauge) 49
Worm Gear Clamps 82, 205
Wrenches (Adjustable) 116
Wrenches (Allen) 116
Wrenches (Beer Related) 121
Wrenches (CO₂) 6
Wrenches (Filter) 69, 71
Wrenches (Refrigeration) 115
Wunderbar Bar Guns & Accessories 30-33
- Z**
Zip Ties (Self Locking) 84, 155



NEW DESIGN BETTER CONNECTION SECONDARY REGULATOR PANELS

(pg. 215)

WITH FOAM PREVENTERS AND TUBING KIT

- MULTIPLE OUTLET AIR DISTRIBUTORS AVAILABLE
- SHUTOFFS WITH BACK CHECK VALVES
- STAINLESS STEEL AND PLASTIC LIQUID CONTACT
- 6' L GAS AND BEER LINES
- EASILY SWITCH INCOMING GAS LINE FROM RIGHT TO LEFT OR PASSTHRU
- TAPRITE REGULATOR BODIES (ON ALL PANELS)



FOXX

EQUIPMENT COMPANY

421 Southwest Blvd.
Kansas City, MO 64108

PRSR-STD
US POSTAGE
PAID
Kansas City, MO
Permit No. 1865

Kansas City Branch

Serving Eastern United States

421 Southwest Blvd
Kansas City, MO 64108

P: 1 (800) 821-2254 || (816) 421-3600
F: 1 (800) 972-0282

M-F: 7am - 5pm CST

kcsales@foxxequipment.com

Denver Branch

Serving Western United States

955 Decatur St. Unit B
Denver, CO 80204

P: 1 (800) 525-2484 || (303) 573-1766
F: 1 (800) 479-8533

M-F: 8am - 5pm MST

denversales@foxxequipment.com



www.foxxequipment.com



SHOP *and* SAVE ONLINE *Specials*

Visit us Online at
WWW.FOXXEQUIPMENT.COM

*"We have no limits to our world. We're only limited by our imagination."
- Bob Ross*



The creative illustrations featured are original works painted on the outside walls of buildings around Kansas City.

We are proud to support the arts in our community and hope these paintings provide a little joy to our employees and all who view them. To see more work by this talented local artist, visit

www.scribeswalk.com